

PINOUT CONFIGURATION

Fig. 2 - SiC783A Pin Configuration

PIN DESCRIPTION		
PIN NUMBER	NAME	FUNCTION
1	ZCD_EN#	ZCD control. Active low
2	V _{CIN}	Supply voltage for internal logic circuitry
3	V _{DRV}	Supply voltage for internal gate driver
4	BOOT	High-side driver bootstrap voltage
5, 37, P1	C _{GND}	Analog ground for the driver IC
6	GH	High-side gate signal
7	PHASE	Return path of high-side gate driver
8 to 14, P2	V _{IN}	Power stage input voltage. Drain of high-side MOSFET
15, 29 to 35, P3	V _{SWH}	Switch node of the power stage
16 to 28	P _{GND}	Power ground
36	GL	Low-side gate signal
38	THWn	Thermal warning open drain output
39	DSBL#	Disable pin. Active low
40	PWM	PWM control input

ORDERING INFORMATION		
PART NUMBER	PACKAGE	MARKING CODE
SiC783ACD-T1-GE3	PowerPAK MLP66-40L	SiC783A
SiC783ADB	Reference Board	

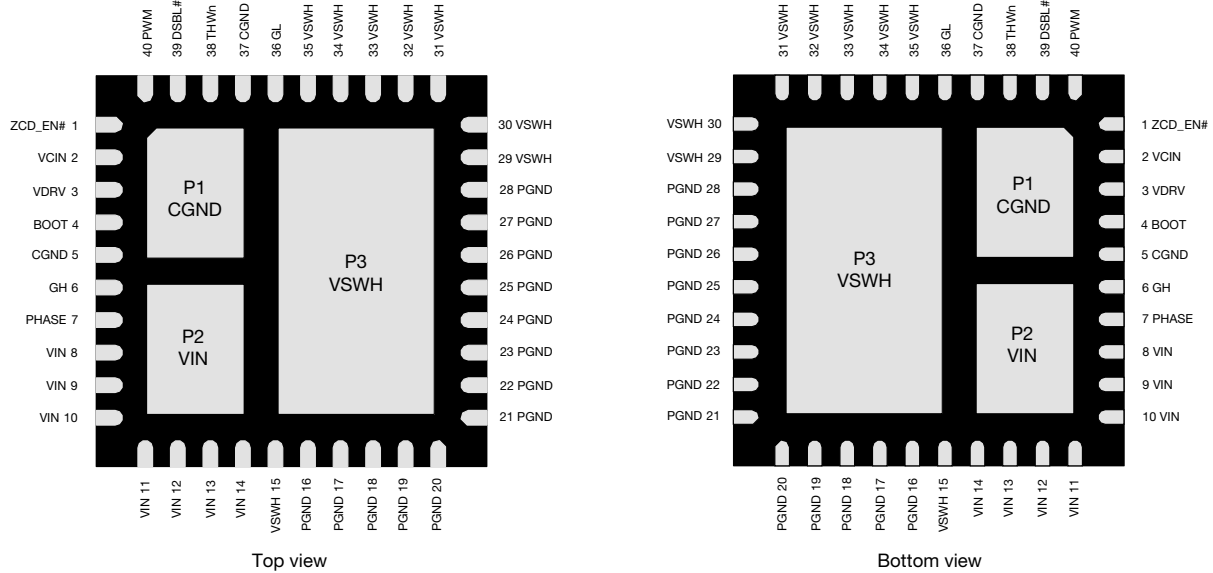

ABSOLUTE MAXIMUM RATINGS			
ELECTRICAL PARAMETER	SYMBOL	LIMITS	UNIT
Input Voltage	V_{IN}	-0.3 to +20	V
Control Logic Supply Voltage	V_{CIN}	-0.3 to +7	
Drive Supply Voltage	V_{DRV}	-0.3 to +7	
Switch Node (DC voltage)	V_{SWH} ⁽¹⁾	-0.3 to +20	
Switch Node (AC voltage) ⁽¹⁾		-7 to +27	
BOOT Voltage (DC voltage)	V_{BOOT}	27	
BOOT Voltage (AC voltage) ⁽²⁾		34	
BOOT to PHASE (DC voltage)	V_{BOOT_PHASE} ⁽³⁾	-0.3 to +7	
BOOT to PHASE (AC voltage) ⁽³⁾		-0.3 to +8	
All Logic Inputs and Outputs (PWM, DSBL#, ZCD_EN# and THWn)		-0.3 to $V_{CIN} + 0.3$	
Max. Operating Junction Temperature	T_J	150	°C
Ambient Temperature	T_A	-40 to +125	
Storage Temperature		-65 to +150	
Electrostatic Discharge Protection	Human body model, JESD22-A114	4000	V
	Charged device model, JESD22-C101	1000	

Notes

- Stresses beyond those listed under “Absolute Maximum Ratings” may cause permanent damage to the device. These are stress ratings only, and functional operation of the device at these or any other conditions beyond those indicated in the operational sections of the specifications is not implied. Exposure to absolute maximum rating conditions for extended periods may affect device reliability.
- (1) The specification values indicate “AC voltage” is V_{SWH} to P_{GND} , -7 V (< 50 ns, 10 μ J), minimum and 27 V (< 50 ns), maximum.
- (2) The specification value indicates “AC voltage” is V_{BOOT} to P_{GND} , 34 V (< 50 ns) maximum.
- (3) The specification value indicates “AC voltage” is V_{BOOT} to V_{PHASE} , 8 V (< 20 ns) maximum.

RECOMMENDED OPERATING RANGE				
ELECTRICAL	MIN.	TYP.	MAX.	UNIT
Input Voltage (V_{IN})	4.5	-	16	V
Drive Supply Voltage (V_{DRV})	4.5	5	5.5	
Control Logic Supply Voltage (V_{CIN})	4.5	5	5.5	
Switch Node (V_{SWH} , DC voltage)	-	-	20	
BOOT to PHASE (V_{BOOT_PHASE} , DC voltage)	4	4.5	5.5	
Thermal Resistance				
Thermal Resistance from Junction to Case	-	2.5	-	°C/W
Thermal Resistance from Junction to PAD	-	1	-	



ELECTRICAL SPECIFICATIONS						
PARAMETER	SYMBOL	TEST CONDITIONS UNLESS OTHERWISE SPECIFIED (DSBL# = ZCD_EN# = 5 V, V _{IN} = 12 V, V _{DRV} = V _{CIN} = 5 V, T _A = 25 °C)	MIN.	TYP. (1)	MAX.	UNIT
POWER SUPPLIES						
Control Logic Supply Current	I _{V_{CIN}}	V _{DSBL#} = 0 V, no switching	-	13	-	μA
		V _{DSBL#} = 5 V, no switching, V _{PWM} = FLOAT	-	300	-	
		V _{DSBL#} = 5 V, f _s = 300 kHz, D = 0.1	-	325	-	
Drive Supply Current	I _{V_{DRV}}	f _s = 300 kHz, D = 0.1	-	16	25	mA
		f _s = 1 MHz, D = 0.1	-	55	-	
		V _{DSBL#} = 0 V, no switching	-	20	-	μA
		V _{DSBL#} = 5 V, no switching	-	55	-	
BOOTSTRAP SUPPLY						
Bootstrap Switch Forward Voltage	V _F	I _F = 2 mA	-	-	0.4	V
PWM CONTROL INPUT						
Rising Threshold	V _{TH_PWM_R}		2.1	2.4	2.8	V
Falling Threshold	V _{TH_PWM_F}		0.7	0.9	1.2	
Tri-state Rising Threshold	V _{TH_TRI_R}		0.9	1.2	1.5	
Tri-state Falling Threshold	V _{TH_TRI_F}		1.9	2.2	2.6	
Tri-state Voltage	V _{TRI}	V _{PWM} = FLOAT	-	1.8	-	
Tri-state Rising Threshold Hysteresis	V _{HYS_TRI_R}		-	250	-	mV
Tri-state Falling Threshold Hysteresis	V _{HYS_TRI_F}		-	350	-	
PWM Current	I _{PWM}	V _{PWM} = 0 V	-	-	-225	μA
		V _{PWM} = 3.3 V	-	-	225	
DRIVER TIMING						
Tri-state to GH/GL Rising Propagation Delay	t _{PD_TRI_R}		-	30	-	ns
Tri-state Hold-Off Time	t _{TSHO}		-	130	-	
GH - Turn Off Propagation Delay	t _{PD_OFF_GH}		-	20	-	
GH - Turn On Propagation Delay (Dead time rising)	t _{PD_ON_GH}		-	8	-	
GL - Turn Off Propagation Delay	t _{PD_OFF_GL}		-	12	-	
GL - Turn On Propagation Delay (Dead time falling)	t _{PD_ON_GL}		-	8	-	
DSBL# Low to GH/GL Falling Propagation Delay	t _{PD_DSBL_F}	Fig. 5	-	15	-	
DSBL#, ZCD_EN# INPUT						
DSBL# Logic Input Voltage	V _{IH_DSBL#}	Input logic high	2	-	-	V
	V _{IL_DSBL#}	Input logic low	-	-	0.8	
ZCD_EN# Logic Input Voltage	V _{IH_ZCD_EN#}	Input logic high	2	-	-	
	V _{IL_ZCD_EN#}	Input logic low	-	-	0.8	



ELECTRICAL SPECIFICATIONS						
PARAMETER	SYMBOL	TEST CONDITIONS UNLESS OTHERWISE SPECIFIED (DSBL# = ZCD_EN# = 5 V, V _{IN} = 12 V, V _{DRV} = V _{CIN} = 5 V, T _A = 25 °C)	MIN.	TYP. ⁽¹⁾	MAX.	UNIT
PROTECTION						
Under Voltage Lockout	V _{UVLO}	V _{CIN} rising, on threshold	-	3.7	4.3	V
		V _{CIN} falling, off threshold	2.7	3.2	-	
Under Voltage Lockout Hysteresis	V _{UVLO_HYST}		-	500	-	mV
THWn Flag Set ⁽²⁾	T _{THWn_SET}		-	160	-	°C
THWn Flag Clear ⁽²⁾	T _{THWn_CLEAR}		-	135	-	
THWn Flag Hysteresis ⁽²⁾	T _{THWn_HYST}		-	25	-	
THWn Output Low	V _{OL_THWn}	I _{THWn} = 2 mA	-	0.02	-	V

Notes

(1) Typical limits are established by characterization and are not production tested.

(2) Guaranteed by design.

DEVICE TRUTH TABLE				
DSBL#	ZCD_EN#	PWM	GH	GL
Open	X	X	L	L
L	X	X	L	L
H	L	L	L	H, I _L > 0 A L, I _L < 0 A
H	L	H	H	L
H	L	Tri-state	L	L
H	H	L	L	H
H	H	H	H	L
H	H	Tri-state	L	L



DETAILED OPERATIONAL DESCRIPTION

PWM Input with Tri-state Function

The PWM input receives the PWM control signal from the VR controller IC. The PWM input is designed to be compatible with standard controllers using two state logic (H and L) and advanced controllers that incorporate tri-state logic (H, L and tri-state) on the PWM output. PWM input operates as follows for two state logic. When PWM is driven above $V_{TH_PWM_R}$ the low-side is turned off and the high-side is turned on. When PWM input is driven below $V_{TH_PWM_F}$ the high-side turns off and the low-side turns on. For tri-state logic, the PWM input operates as above for driving the MOSFETs. However, if the PWM input stays tri-state for the tri-state hold-off period, t_{TSHO} , both high-side and low-side MOSFETs are turned off. This function allows the VR phase to be disabled without negative output voltage swing caused by inductor ringing and saves a Schottky diode clamp. The PWM and tri-state regions are separated by hysteresis to prevent false triggering.

The SiC783A incorporates PWM voltage thresholds that are compatible with 3.3 V logic.

Disable (DSBL#)

In the low-state, the DSBL# pin shuts down the driver IC and disables both high-side and low-side MOSFETs. In this state, the standby current is minimized. If DSBL# is left unconnected an internal pull-down resistor will pull the pin down to C_{GND} and shut down the IC.

Diode Emulation Mode (ZCD_EN#)

When ZCD_EN# pin is low and PWM signal switches low, GL is forced on (after normal BBM time). During this time, it is under control of the ZCD (zero crossing detect) comparator. If, after the internal blanking delay, the inductor current becomes zero, GL is turned off. This improves light load efficiency by avoiding discharge of output capacitors.

If PWM enters tri-state, then device will go into normal tri-state mode after tri-state Delay. The GL output will be turned off regardless of Inductor current, this is an alternative method of improving light load efficiency by reducing switching losses.

Thermal Warning (THWn)

The THWn pin is an open drain signal that flags the presence of excessive junction temperature. Connect a maximum of 20 k Ω to pull this pin up to V_{CIN} . An internal temperature sensor detects the junction temperature. The temperature threshold is 160 °C. When this junction temperature is exceeded the THWn flag is set. When the junction temperature drops below 135 °C the device will clear the THWn signal. The SiC783A does not stop operation when the flag is set. The decision to shutdown must be made by an external thermal control function.

Voltage Input (V_{IN})

This is the power input to the drain of the high-side power MOSFET. This pin is connected to the high power intermediate BUS rail.

Switch Node (V_{SWH} and PHASE)

The switch node, V_{SWH} , is the circuit power stage output. This is the output applied to the power inductor and output filter to deliver the output for the buck converter.

The PHASE pin is internally connected to the switch node V_{SWH} . This pin is to be used exclusively as the return pin for the BOOT capacitor. A 20 k Ω resistor is connected between GH and PHASE to provide a discharge path for the HS MOSFET in the event that V_{CIN} goes to zero while V_{IN} is still applied.

Ground Connections (C_{GND} and P_{GND})

P_{GND} (power ground) should be externally connected to C_{GND} (control signal ground). The layout of the printed circuit board should be such that the inductance separating C_{GND} and P_{GND} is minimized. Transient differences due to inductance effects between these two pins should not exceed 0.5 V.

Control and Drive Supply Voltage Input (V_{DRV} , V_{CIN})

V_{CIN} is the bias supply for the gate drive control IC. V_{DRV} is the bias supply for the gate drivers. It is recommended to separate these pins through a resistor. This creates a low pass filtering effect to avoid coupling of high frequency gate driver noise into the IC.

Bootstrap Circuit (BOOT)

An integrated bootstrap diode is incorporated so that only an external capacitor is necessary to complete the bootstrap circuit. Connect a bootstrap capacitor with one leg tied to BOOT pin and the other tied to PHASE pin.

PWM TIMING DIAGRAM

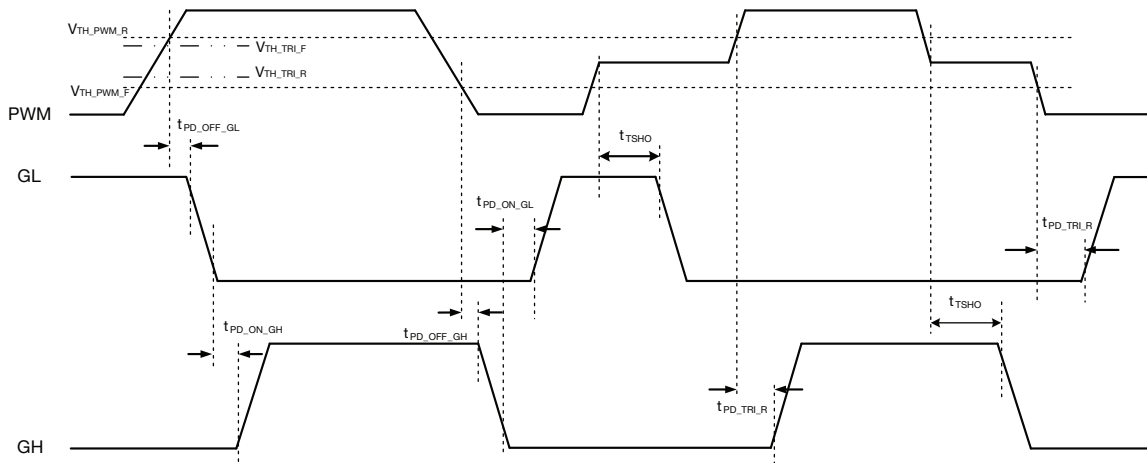
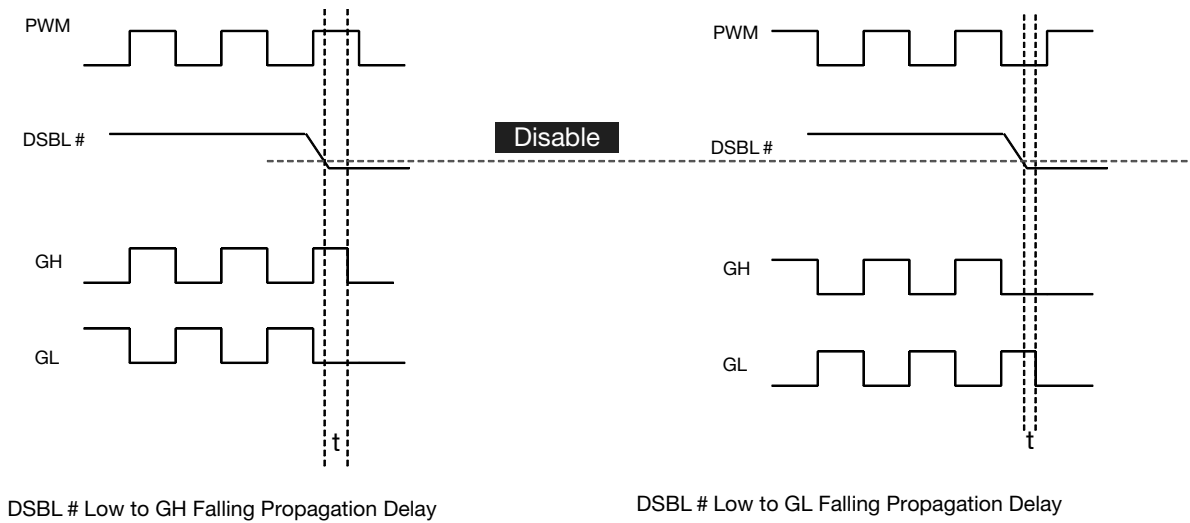

Fig. 4 - Definition of PWM Logic and Tri-State

OPERATION TIMING DIAGRAM: DSBL#



DSBL # Low to GH Falling Propagation Delay

DSBL # Low to GL Falling Propagation Delay

Fig. 5 - DSBL# Propagation Delay

ELECTRICAL CHARACTERISTICS

($V_{IN} = 12\text{ V}$, $F_{SW} = 500\text{ kHz}$, $V_{DRV} = V_{CIN} = 5\text{ V}$, $L_{O/P} = 0.33\text{ }\mu\text{H}$ / DCR $0.83\text{ m}\Omega$ (IHLP-5050FD0R33-01), unless noted otherwise)

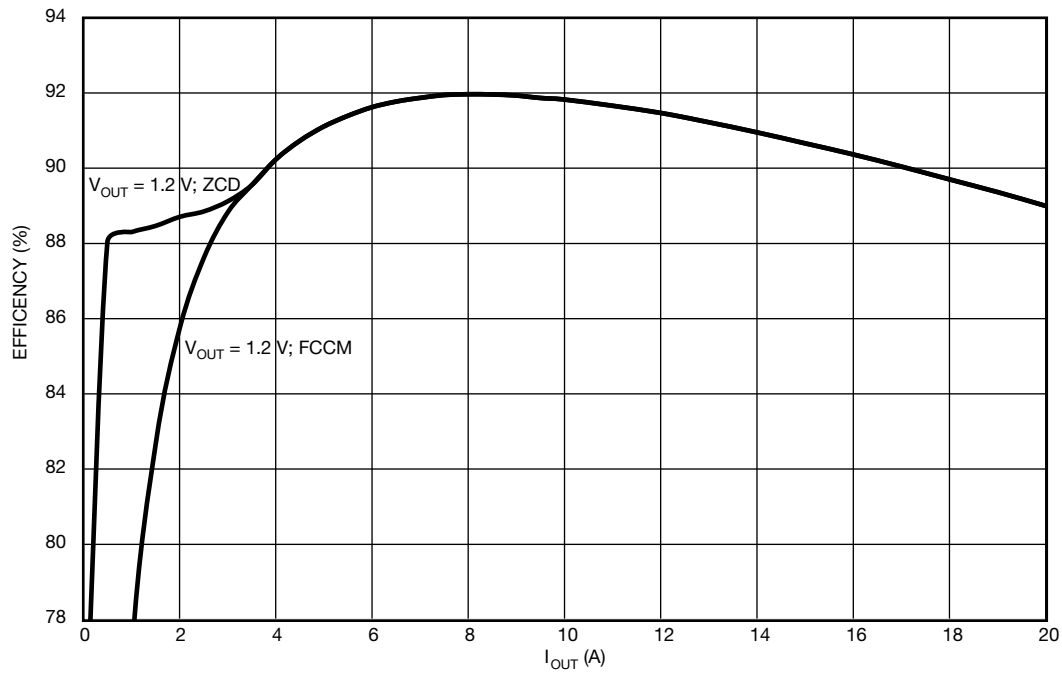

Fig. 6 - Efficiency vs. I_{OUT}

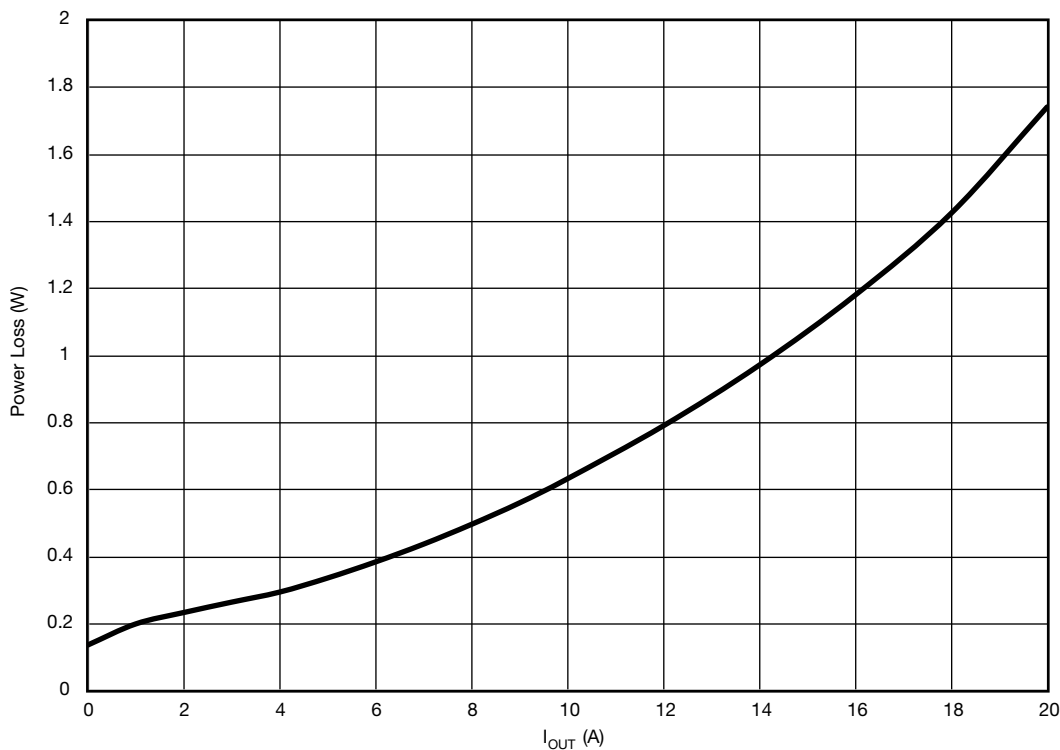

Fig. 7 - Power Stage Power Loss vs. I_{OUT}

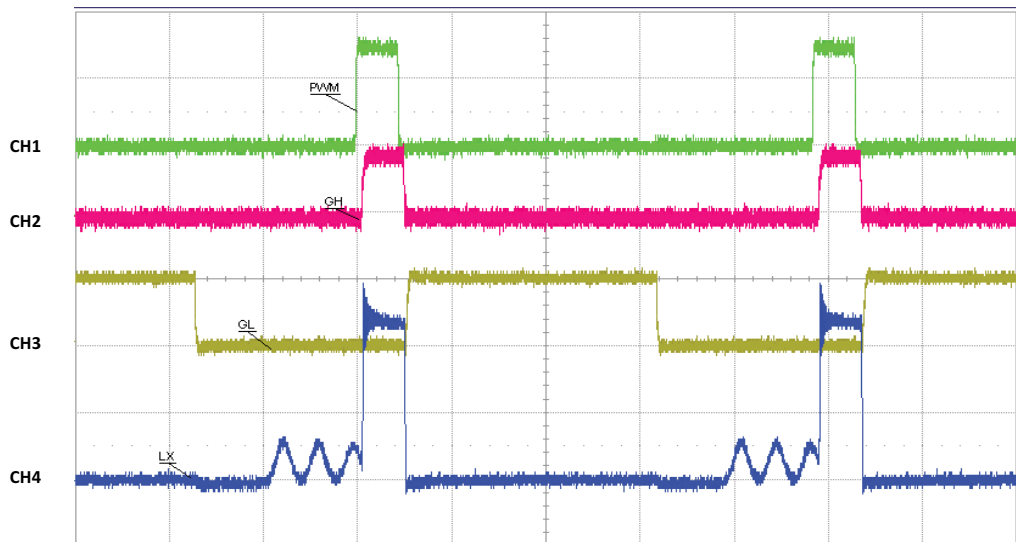
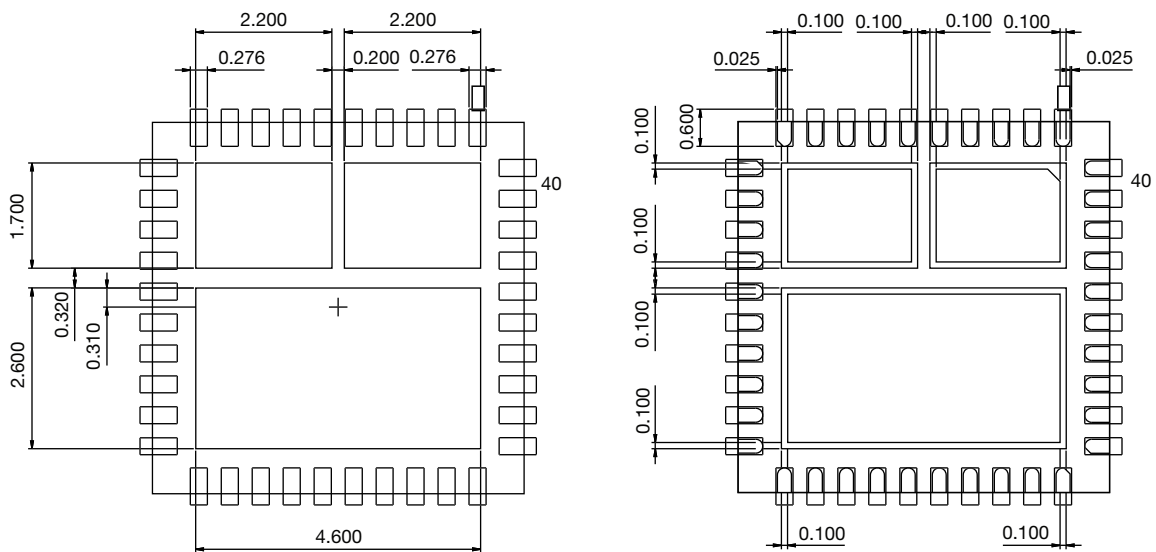

Fig. 8 - Zero Cross Detect Mode Operation (ZCD)

CH1 (green) = PWM (2V/div), CH2 (red) = GH (5V/div), CH3 (yellow) = GL (5V/div), CH4 (blue) = V_{swH} (5V/div)

RECOMMENDED LAND PATTERN PowerPAK MLP66-40L



All Dimensions are in millimeters



PACKAGE OUTLINE DRAWING

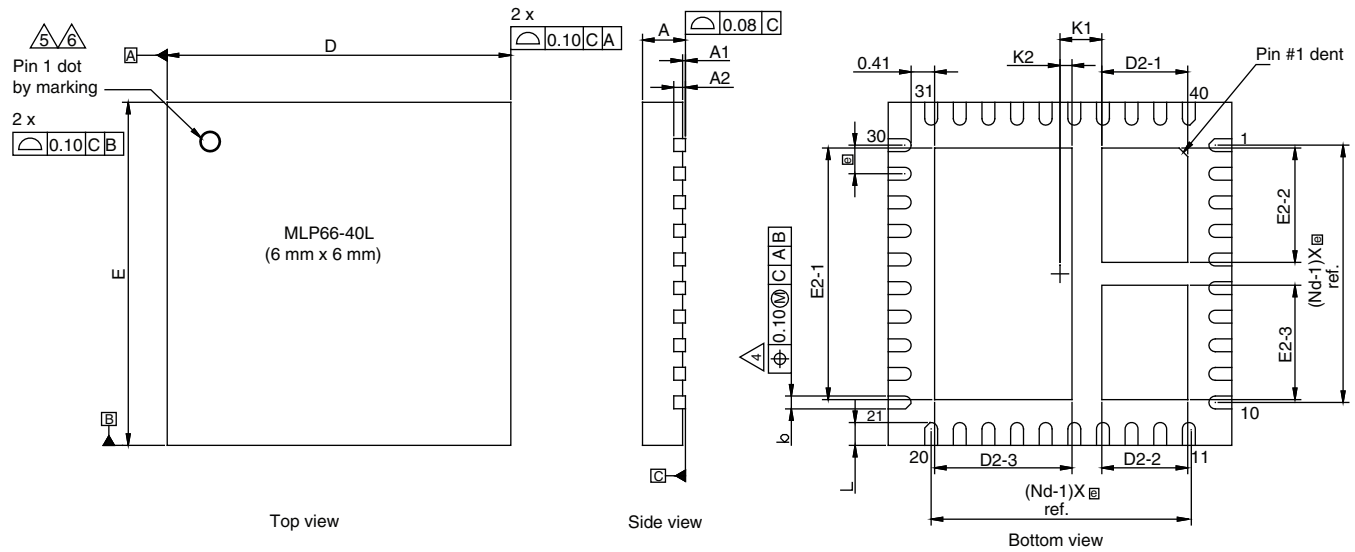

DIM.	MILLIMETERS			INCHES		
	MIN.	NOM.	MAX.	MIN.	NOM.	MAX.
A	0.70	0.75	0.80	0.027	0.029	0.031
A1	0.00	-	0.05	0.000	-	0.002
A2	0.20 ref.			0.008 ref.		
b	0.20	0.25	0.30	0.078	0.098	0.011
D	6.00 BSC			0.236 BSC		
e	0.50 BSC			0.019 BSC		
E	6.00 BSC			0.236 BSC		
L	0.35	0.40	0.45	0.013	0.015	0.017
N	40			40		
Nd	10			10		
Ne	10			10		
D2-1	1.45	1.50	1.55	0.057	0.059	0.061
D2-2	1.45	1.50	1.55	0.057	0.059	0.061
D2-3	2.35	2.40	2.45	0.095	0.094	0.096
E2-1	4.35	4.40	4.45	0.171	0.173	0.175
E2-2	1.95	2.00	2.05	0.076	0.078	0.080
E2-3	1.95	2.00	2.05	0.076	0.078	0.080
K1	0.73 BSC			0.028 BSC		
K2	0.21 BSC			0.008 BSC		

Vishay Siliconix maintains worldwide manufacturing capability. Products may be manufactured at one of several qualified locations. Reliability data for Silicon Technology and Package Reliability represent a composite of all qualified locations. For related documents such as package/tape drawings, part marking, and reliability data, see www.vishay.com/ppg?64902.



PowerPAK® MLP66-40 Case Outline

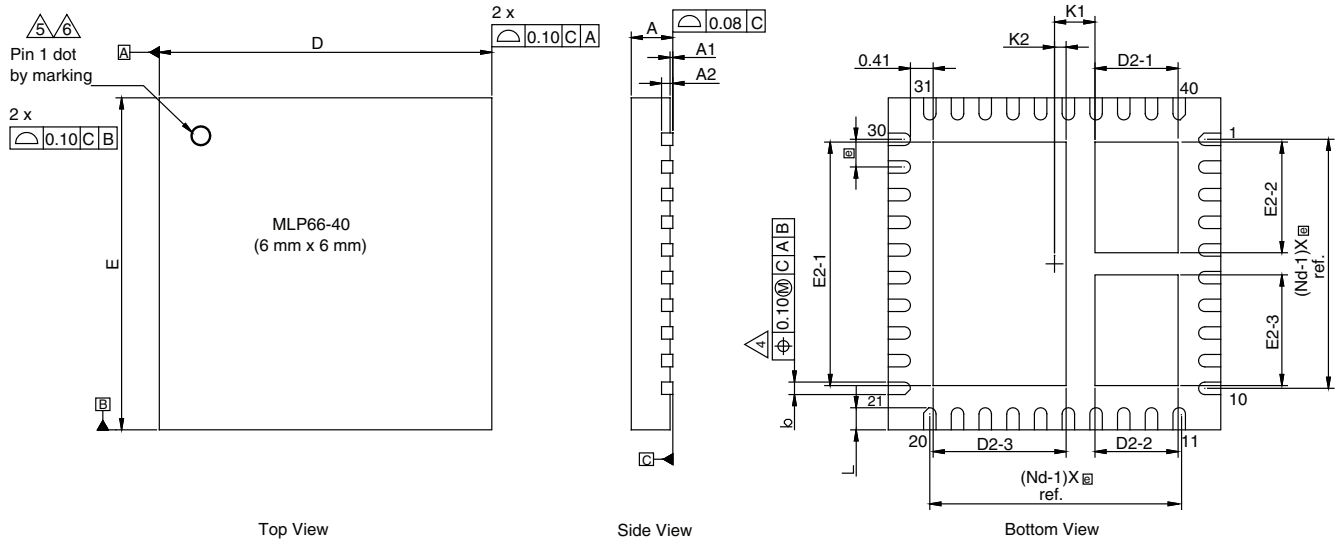

DIM.	MILLIMETERS			INCHES		
	MIN.	NOM.	MAX.	MIN.	NOM.	MAX.
A ⁽⁸⁾	0.70	0.75	0.80	0.027	0.029	0.031
A1	0.00	-	0.05	0.000	-	0.002
A2	0.20 ref.			0.008 ref.		
b ⁽⁴⁾	0.20	0.25	0.30	0.078	0.098	0.011
D	6.00 BSC			0.236 BSC		
e	0.50 BSC			0.019 BSC		
E	6.00 BSC			0.236 BSC		
L	0.35	0.40	0.45	0.013	0.015	0.017
N ⁽³⁾	40			40		
Nd ⁽³⁾	10			10		
Ne ⁽³⁾	10			10		
D2-1	1.45	1.50	1.55	0.057	0.059	0.061
D2-2	1.45	1.50	1.55	0.057	0.059	0.061
D2-3	2.35	2.40	2.45	0.095	0.094	0.096
E2-1	4.35	4.40	4.45	0.171	0.173	0.175
E2-2	1.95	2.00	2.05	0.076	0.078	0.080
E2-3	1.95	2.00	2.05	0.076	0.078	0.080
K1	0.73 BSC			0.028 BSC		
K2	0.21 BSC			0.008 BSC		
ECN: T14-0826-Rev. B, 12-Jan-15						
DWG: 5986						

Notes

1. Use millimeters as the primary measurement
2. Dimensioning and tolerances conform to ASME Y14.5M. - 1994
3. N is the number of terminals. Nd is the number of terminals in X-direction and Ne is the number of terminals in Y-direction
4. Dimension b applies to plated terminal and is measured between 0.20 mm and 0.25 mm from terminal tip
5. The pin #1 identifier must be existed on the top surface of the package by using indentation mark or other feature of package body
6. Exact shape and size of this feature is optional
7. Package warpage max. 0.08 mm
8. Applied only for terminals



Disclaimer

ALL PRODUCT, PRODUCT SPECIFICATIONS AND DATA ARE SUBJECT TO CHANGE WITHOUT NOTICE TO IMPROVE RELIABILITY, FUNCTION OR DESIGN OR OTHERWISE.

Vishay Intertechnology, Inc., its affiliates, agents, and employees, and all persons acting on its or their behalf (collectively, "Vishay"), disclaim any and all liability for any errors, inaccuracies or incompleteness contained in any datasheet or in any other disclosure relating to any product.

Vishay makes no warranty, representation or guarantee regarding the suitability of the products for any particular purpose or the continuing production of any product. To the maximum extent permitted by applicable law, Vishay disclaims (i) any and all liability arising out of the application or use of any product, (ii) any and all liability, including without limitation special, consequential or incidental damages, and (iii) any and all implied warranties, including warranties of fitness for particular purpose, non-infringement and merchantability.

Statements regarding the suitability of products for certain types of applications are based on Vishay's knowledge of typical requirements that are often placed on Vishay products in generic applications. Such statements are not binding statements about the suitability of products for a particular application. It is the customer's responsibility to validate that a particular product with the properties described in the product specification is suitable for use in a particular application. Parameters provided in datasheets and / or specifications may vary in different applications and performance may vary over time. All operating parameters, including typical parameters, must be validated for each customer application by the customer's technical experts. Product specifications do not expand or otherwise modify Vishay's terms and conditions of purchase, including but not limited to the warranty expressed therein.

Except as expressly indicated in writing, Vishay products are not designed for use in medical, life-saving, or life-sustaining applications or for any other application in which the failure of the Vishay product could result in personal injury or death. Customers using or selling Vishay products not expressly indicated for use in such applications do so at their own risk. Please contact authorized Vishay personnel to obtain written terms and conditions regarding products designed for such applications.

No license, express or implied, by estoppel or otherwise, to any intellectual property rights is granted by this document or by any conduct of Vishay. Product names and markings noted herein may be trademarks of their respective owners.