

EVK-NINA-B4

Evaluation kit for NINA-B4 modules

User guide

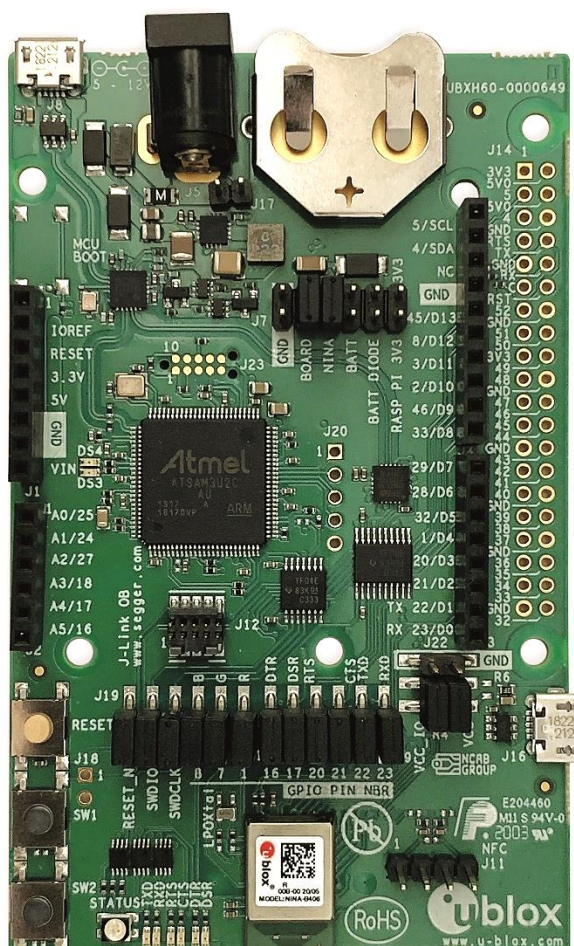

Abstract

This document describes how to set up the EVK-NINA-B4 evaluation kit to evaluate NINA-B4 series standalone Bluetooth® 5.1 low energy modules. It also describes the different options for debugging and testing the development capabilities included in the evaluation board.

Document information

Title	EVK-NINA-B4	
Subtitle	Evaluation kit for NINA-B4 modules	
Document type	User guide	
Document number	UBX-19054587	
Revision and date	R04	29-Jun-2021
Disclosure restriction	C1 - Public	

This document applies to the following products:

Product name
EVK-NINA-B400
EVK-NINA-B410
EVK-NINA-B410DF
EVK-NINA-B406
EVK-NINA-B416

u-blox or third parties may hold intellectual property rights in the products, names, logos and designs included in this document. Copying, reproduction, modification or disclosure to third parties of this document or any part thereof is only permitted with the express written permission of u-blox.

The information contained herein is provided "as is" and u-blox assumes no liability for its use. No warranty, either express or implied, is given, including but not limited to, with respect to the accuracy, correctness, reliability and fitness for a particular purpose of the information. This document may be revised by u-blox at any time without notice. For the most recent documents, visit www.u-blox.com.

Copyright © u-blox AG.

Contents

Document information	2
Contents	3
1 Quick start guide.....	5
2 Product description.....	6
2.1 Overview.....	6
2.2 Kit includes	7
2.3 Key features	7
2.4 EVK-NINA-B4 block diagram	8
2.5 Connectors	9
3 Setting up the evaluation board.....	10
3.1 Evaluation board setup.....	10
3.2 Starting up	10
3.2.1 EVK-NINA-B41x	10
3.2.2 EVK-NINA-B40x	11
3.3 Measuring current consumption	11
3.3.1 Using an ampere meter	11
3.3.2 Using a voltmeter	12
3.3.3 Using an external power supply or power analyzer.....	13
4 Board configuration.....	14
4.1 Powering options.....	14
4.1.1 Selecting the power configuration jumpers	14
4.1.2 Default power configuration, 3.3 V	17
4.1.3 Battery powered, 3–1.7 V	18
4.1.4 Battery powered with protection diode, 2.7–1.7 V.....	19
4.1.5 External supply, 3.6–1.7 V.....	20
4.1.6 Raspberry Pi HAT.....	21
4.2 Disconnecting NINA signals from board peripherals	21
4.3 Connecting an external antenna (EVK-NINA-B410DF).....	23
5 Interfaces and peripherals	24
5.1 Buttons and LEDs	24
5.2 Arduino interface	25
5.2.1 Arduino shield compatibility.....	27
5.3 Raspberry Pi compatible interface	27
5.3.1 Powering considerations.....	30
5.3.2 UART	30
5.3.3 EEPROM support	30
5.4 Additional Interfaces	30
5.4.1 Extra memory – external Flash	32
5.4.2 Extra USB to UART interface	32
5.4.3 CPU trace interface	33

Appendix	34
A Schematics	34
B Glossary	38
Related documents	39
Revision history	39
Contact	40

1 Quick start guide

EVK-NINA-B4 software and documentation is available at www.u-blox.com/evk-search.

Install s-center evaluation software

s-center is a powerful and easy-to-use tool for evaluating, configuring, and testing u-blox short range modules. Running on Windows 10 operating systems, the software allows end users to assess and configure u-blox short range modules using the EVK.

Follow the procedure outlined below to download and install the s-center software and documentation. The software can be downloaded from the u-blox [s-center](#) product page and is available free of charge.



1. Download the latest s-center software to your computer.
2. Open the s-center setup installer to install the software.
3. Select Launch button in the installer or open the application from the Windows Start button.

Install J-Link drivers

Follow the procedure outlined below to install the J-Link drivers needed for programming the module.

1. Connect the EVK-NINA-B4 board to your PC using the USB cable provided with the product.
2. Verify that the USB drivers are installed successfully. Check the [Evaluation board setup](#) if the drivers do not install automatically.
3. Once the drivers are installed, a COM port is enabled in Windows. Use the Windows Device Manager to view the port number (COM #) for the USB serial port.
4. Start s-center to communicate with the module.

For EVK-NINA-B4x0 (with external antenna), attach the antenna to the antenna cable and connect the antenna cable to the U.FL connector.

-  The initial prototypes of EVK-NINA-B406, marked with PT1 (date code 1950 or older) have a different pin out and some hardware limitations. This is described in the sample delivery notes that come with the prototypes.
-  For EVK-NINA-B410DF flashing tools and procedures, see also the Indoor direction finding XPLR-AOA explorer kits user guide [8].

2 Product description

2.1 Overview

The u-blox EVK-NINA-B4 evaluation kit is a versatile development platform that allows quick prototyping of a variety of extremely low-powered Internet of Things (IoT) applications, using full Bluetooth 5.1, NFC, and IEEE 802.15.4.

EVK-NINA-B4 boards are available in the following four variants that accommodate alternative antenna and software solutions:

- EVK-NINA-B400, with open CPU NINA-B400 module and U.FL antenna connector for connecting to external antennas. The EVK-NINA-B400 is also used for evaluation of NINA-B401 module.
- EVK-NINA-B410, with u-connect NINA-B410 module pre-flashed with u-connectXpress software or boot prepared for u-connectLocate software (EVK-NINA-B410DF), and U.FL antenna connector for connecting to external antennas. The EVK-NINA-B410 version is also used for evaluation of NINA-B411 module.
- EVK-NINA-B406, with open CPU NINA-B406 module that includes an internal PCB trace antenna.
- EVK-NINA-B416, with u-connect NINA-B416 module pre-flashed with u-connectXpress software and an internal PCB trace antenna.

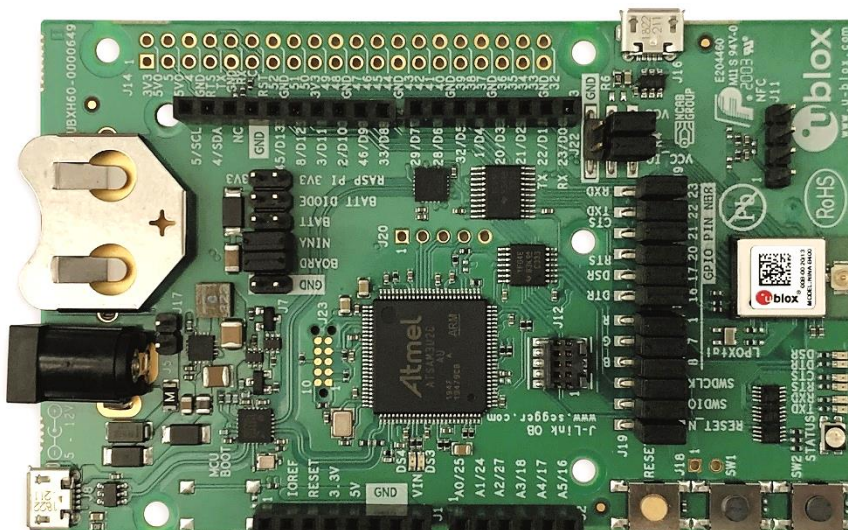

Figure 1: EVK-NINA-B400/B410 evaluation board

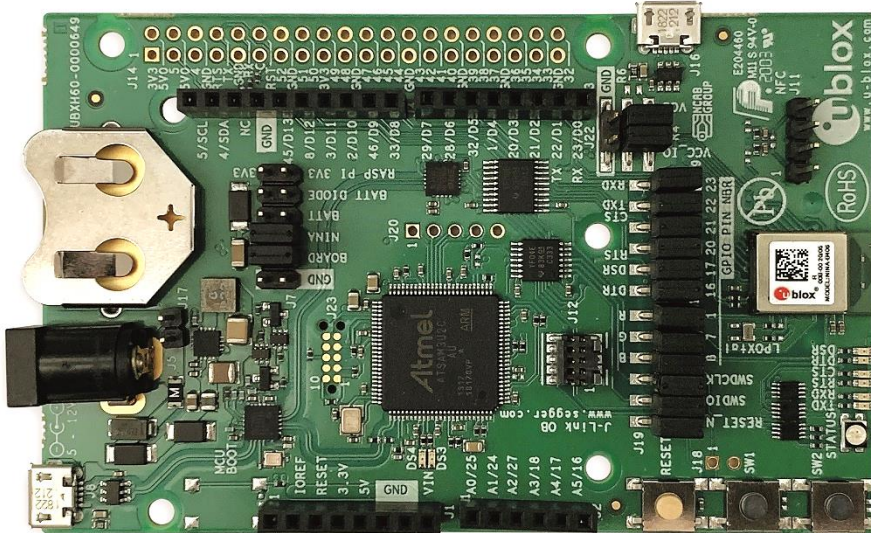

Figure 2: EVK-NINA-B406/B416 evaluation board

All NINA-B4 standalone modules include an Arm® Cortex®-M4F microcontroller with a 64 MHz system clock, 512kB internal flash and 128 kB RAM.

EVK-NINA-B4 evaluation boards provide access to the 38 GPIO pins and interfaces that are supported on NINA-B4 modules. The interfaces are available through a variety of connectors, including Arduino™ Uno R3 [1] and Raspberry Pi [2] header connectors. The boards also provide simple USB drag-n-drop programming and a SEGGER J-Link debug interface that can be used with the Open CPU variants of the EVK.

Nordic Semiconductors, the manufacturer of the nRF52833 SoC, provide a free Software Development Kit (SDK) that includes a broad selection of drivers, libraries, and example applications that can be used for rapid prototyping.

2.2 Kit includes

The EVK-NINA-B4 evaluation kit includes the following:

- NINA-B4 evaluation board
- 2.4 GHz antenna with U.FL connector (only in EVK-NINA-B400 and EVK-NINA-B410)
- NFC antenna
- USB cable

2.3 Key features

- u-blox NINA-B4 Bluetooth Low Energy module based on the Nordic nRF52833 SoC
 - Full Bluetooth 5.1 support
 - NFC tag functionality
 - 802.15.4 PHY
 - Integrated Arm Cortex-M4 microcontroller with 512kB internal flash and 128 kB RAM, and 64 MHz system clock
 - USB 2.0
 - Wide 1.7-3.6 V supply range
- The NINA-B4 module supports different interfaces that can be configured to any of the 38 available GPIO pin(s):
 - 8 analog capable inputs
 - 16 PWM capable outputs
 - 4x SPI

- 2x UART with HW flow control
- 2x I2C
- 1x I2S
- 1x PDM input
- 1x Quadrature decoder
- EVK-NINA-B41x: support for u-connectXpress software
- EVK-NINA-B40x: support for developing your own software on the Open CPU NINA-B4 module
- Full UART to USB converter with a Virtual COM port, allowing control of the extended UART features of the u-connectXpress software
- On-board J-Link debugger/programmer
 - Mass Storage Device interface to PC, for drag-n-drop programming
 - Debug port
 - An additional Virtual COM port that, for example, may be connected to add-on boards or to a debug UART on the NINA-B4
- Dedicated USB connector for the NINA-B4 USB interface
- Additional flash memory can be added to the board for use by the NINA-B4 module
- RGB LED and push-buttons
- Arduino UNO R3 and Raspberry Pi compatible pin header interfaces
- Jumper headers and level shifters allow for flexible powering options of the NINA-B4 module, even with full board support. They isolate the module entirely and control each power net separately to precisely measure low power applications or disconnect only unused parts of the board to save battery life.
- Multiple board power supply options
 - 5–12 V power plug
 - 5 V USB supply
 - 5–12 V Arduino VIN input
- Battery holder supporting CR2032 coin cell batteries

2.4 EVK-NINA-B4 block diagram

Figure 3 shows the major interfaces and internal connections of the EVK-NINA-B4.

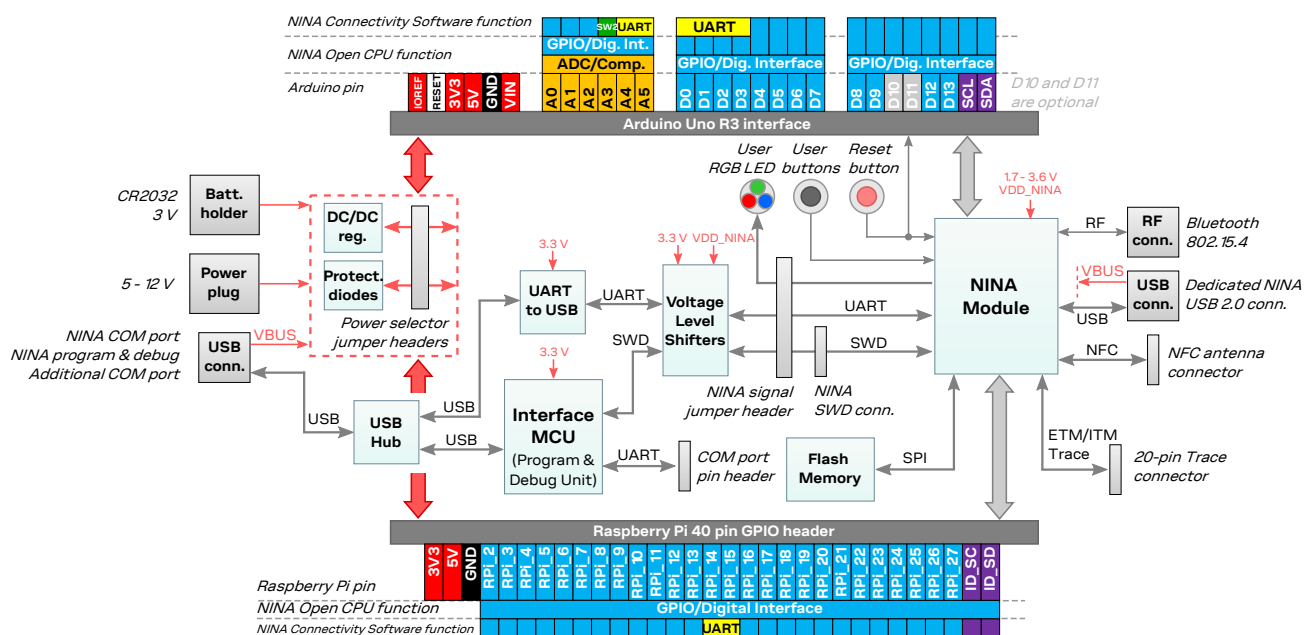

Figure 3: EVK-NINA-B4 block diagram

2.5 Connectors

Table 1 describes the available connectors of the EVK-NINA-B4 shown in Figure 4.

Connector	Function	Description
J5	Power supply	2.1 mm power jack, the center pin is the positive terminal. 5 – 12 V input.
J17	Power supply	Pin header that can be used to connect external power supplies. 5 – 12 V input.
BT1	Battery holder	CR2032 coin cell battery holder. CR2032 usually has a 3 V potential when fully charged.
J11	NFC antenna connector	Pin header that connects to the u-blox NFC antenna included in the kit. The antenna can be mounted in either direction.
(J2)	2.4 GHz RF antenna connector	U.FL coaxial connector that can be used to connect antennas or RF equipment. This connector is only included in the EVK-NINA-B400/EVK-NINA-B410.
J12	Cortex Debug connector	10-pin, 50 mil pitch connector that can be used to connect external debuggers to the NINA-B4 module. The NINA-B4 modules support Serial Wire debug (SWD) and Serial Wire Viewer, but not JTAG debug.
J8	Power supply, COM port and debug USB	The main USB connector that is used to program, debug, and communicate with the NINA module. It can also be used to power the entire board.
J16	Power supply and NINA USB port	Additional USB connector directly connected to the NINA-B4 USB interface. Can also be used to power the entire board.

Table 1: EVK-NINA-B4 connector description

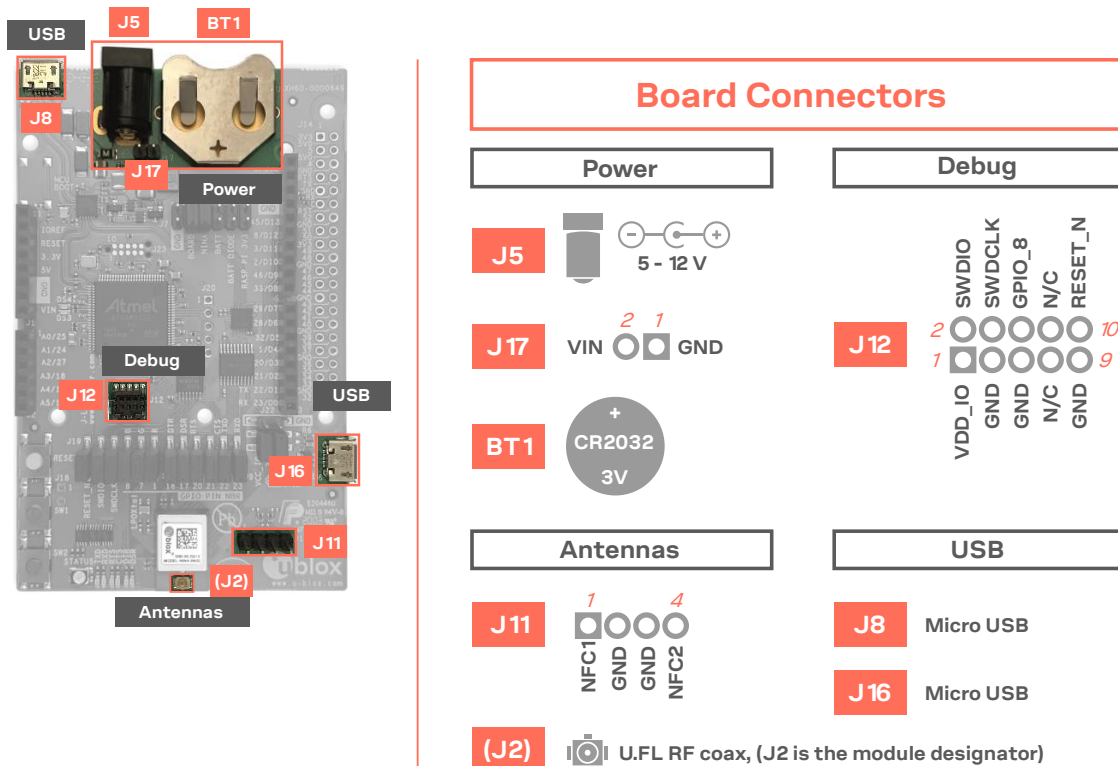

Figure 4: Available connectors and their pinout

3 Setting up the evaluation board



3.1 Evaluation board setup

EVK-NINA-B410 and EVK-NINA-B416 boards are delivered with pre-installed u-connectXpress software. EVK-NINA-B410DF is delivered with a pre-installed boot for download of u-connectLocate software.

Before connecting the evaluation board, download and install the latest u-blox s-center evaluation software from the u-blox website.

To use Bluetooth Low Energy on EVK-NINA-B410 and EVK-NINA-B416 boards, connect a 2.4 GHz antenna to the U.FL antenna connector. The EVK-NINA-B400 and EVK-NINA-B406 board variants include antennas on the NINA module.

Plug in either an external power supply in the J5 connector or connect to a USB host with a USB cable attached to the J8 connector. You can also power the evaluation board with a CR2032 coin cell battery. The NFC antenna can be connected to the J11 connector.

-  Make sure that the power configuration jumpers are connected according to your use case, as described in [Powering options](#). The [Default power configuration, 3.3 V](#) works for most use cases.
-  Be careful to check polarity before connecting an external power supply to the EVK-NINA-B4 evaluation board. Center conductor is positive (+) and the ring is negative (-).

The operating system installs the correct drivers automatically. The drivers need only be installed once when you connect the unit to a new computer.

-  If the drivers are not installed automatically, download the J-Link driver included in the [Nordic nRF Command Line Tools](#).

Two COM ports are automatically assigned to the unit by Windows:

- The COM port labelled “USB Serial Port” is used to communicate with the UART interface of the NINA-B4 module.
- The COM port labelled “JLink CDC UART Port” can be used as an extra USB to the UART interface. See also [Extra USB to UART interface](#).

Use the following procedure to view the assigned COM ports on Windows 7:

1. Open the Control Panel and select Hardware and Sound.
2. Open the Device Manager in Devices and Printers. This opens the Device Manager window where you can view the assigned COM ports.
3. To view the assigned COM ports on Windows 10, right click the Windows Start button and select Device Manager.

3.2 Starting up

3.2.1 EVK-NINA-B41x

To communicate with the module using AT commands, install and start the s-connect evaluation software (see [Quick start guide](#)), and set the baud rate to 115200, 8N1 with flow control. All available AT commands are described in the u-connect AT commands manual [5].

To get started with the basic use case set up of the EVK-NINA-B4 with u-blox u-connect software, see also the u-connectXpress user guide [7].

3.2.1.1 u-connectXpress software

EVK-NINA-B41x is equipped with a NINA-B41x module that runs the u-connectXpress software. The software is preinstalled on the module.

 Go to the u-blox support webpage to obtain the latest available software. Instructions on reflashing the EVK-NINA-B4 can be found in the Software section of the NINA-B4 system integration manual [4].

3.2.1.2 u-connectLocate software

EVK-NINA-B410DF is equipped with a NINA-B410-40B module that runs the u-connectLocate software. The software needs to be downloaded to the module. Note that the NINA-B41x-40B modules are not compatible with u-connectXpress software, only the u-connectLocate software.

 Go to the u-blox support webpage to obtain the latest available software. Instructions on flashing the EVK-NINA-B410DF can be found in the Indoor direction finding XPLR-AOA explorer kits User Guide [8].

3.2.2 EVK-NINA-B40x

3.2.2.1 Nordic Semiconductor SDK

To use the EVK-NINA-B40x together with Nordic Semiconductor SDK it is necessary to:

- Create your own board file
- Adapt the examples in the Nordic Semiconductor SDK to use this board file

For more information about performing these tasks, see the Software section of the NINA-B4 system integration manual [4]. See also the u-blox short range open CPU github repository [9].

3.2.2.2 Software debug options

Use either of the following options to debug software with EVK-NINA-B4:

- Onboard debug solution available through the USB connector
- External debugger connected to J12 connector

An external debugger is useful when powering the evaluation board with a CR2032 coin cell battery, or through the J5 external power supply connector. It is also useful when the MCU interface has been disconnected from the NINA-B4 module using the jumpers on the J19 header.

SEGGER J-Link software [6] is necessary to debug with the onboard J-Link hardware on the EVK-NINA-B4.

3.3 Measuring current consumption

 Before starting the current consumption measurement, go through Chapter 4 to identify your chosen power configuration and find out what NINA signals must subsequently be isolated. The J22 jumper pins 1 and 3 must be removed to measure the current consumption.

Figure 5 shows some suggestions for connecting the various instruments when measuring module current consumption.

3.3.1 Using an ampere meter

An ampere meter should be connected in series with whatever the power source is and what is being measured. In this way the current can be measured when the NINA module is supplied from either the onboard 3.3 V regulator or an external supply.

3.3.2 Using a voltmeter

The EVK board must be modified before module current can be measured with a voltmeter.

To modify the board, solder a low resistance, high tolerance, 0402 sized resistor to the footprint labeled R6. This resistor replaces the jumper normally positioned between J22 pins - 1 and 3, and any current running through it produce a voltage across its terminals. Measure this voltage with the voltmeter and calculate the current using Ohm's law.

3.3.3 Using an external power supply or power analyzer

Connect the terminals of the instrument to the EVK pins, as shown in Figure 5. An ampere meter can also be added in series.

Since the external voltage of any connected instrument can never perfectly match the 3.3 V generated by the EVK, some small current leakage is apparent whenever the signal from the NINA module is connected to an EVK peripheral. The leakage is typically in the order of 100's of nano amps.

To reduce leakage current, use a second external power channel to supply the EVK peripherals. This second channel must also be used to enable PC communication when using NINA supply voltages other than 3.3 V.

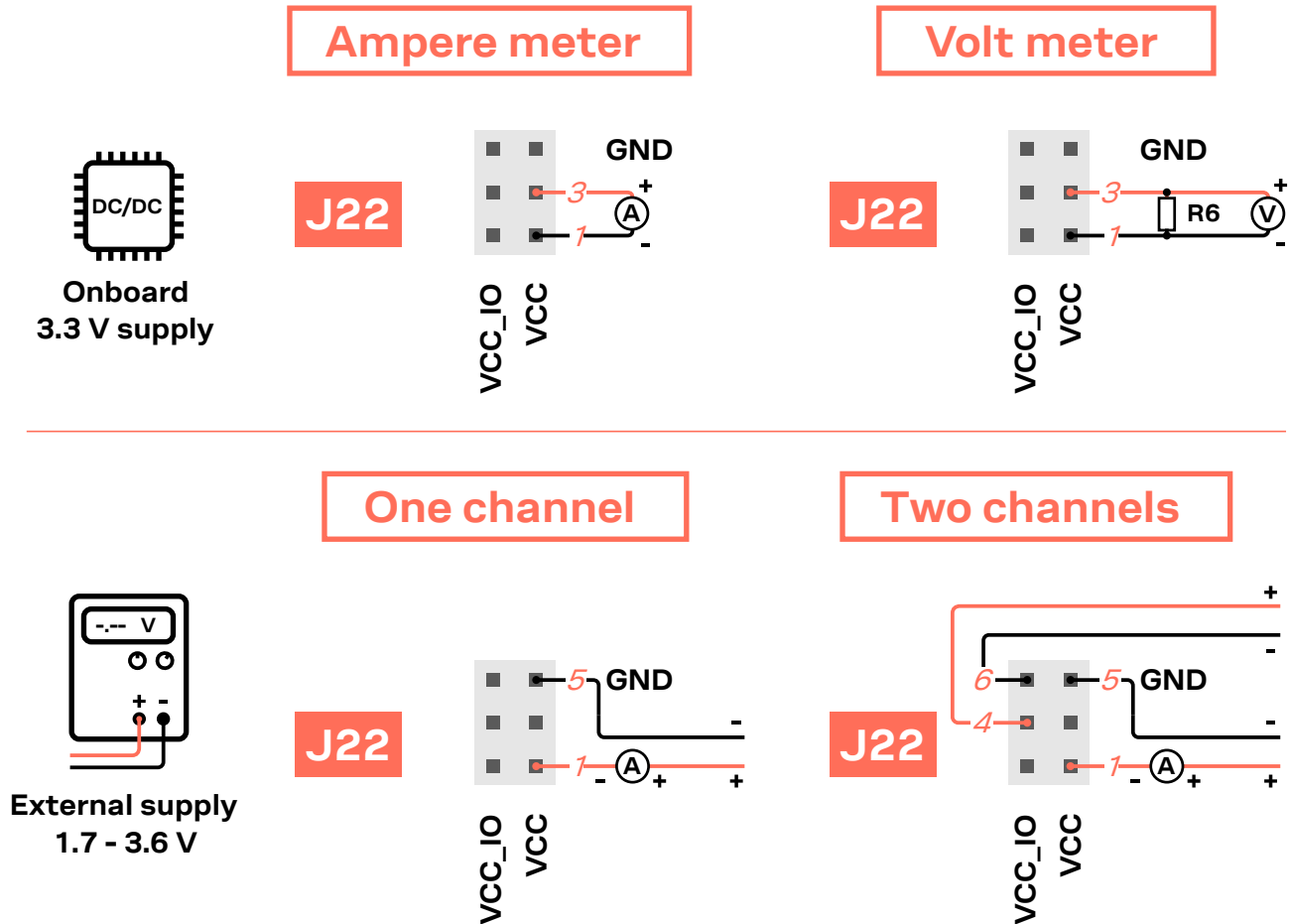

Figure 5: Different options when measuring the NINA module's current consumption

4 Board configuration

4.1 Powering options

Power can be supplied to the board in any of the following ways:

- Via any of the USB connectors, J8 or J16
- Using the power jack, J5
- Using the Arduino interface VIN or 5V pin, J1.8 or J1.5
- Using the Raspberry Pi interface 5V pins, J14.2 or J14.4
- Using the pin header J17
- Plugging in a battery to the battery holder BT1

These power supply sources are distributed to the rest of the board as shown in Figure 6.

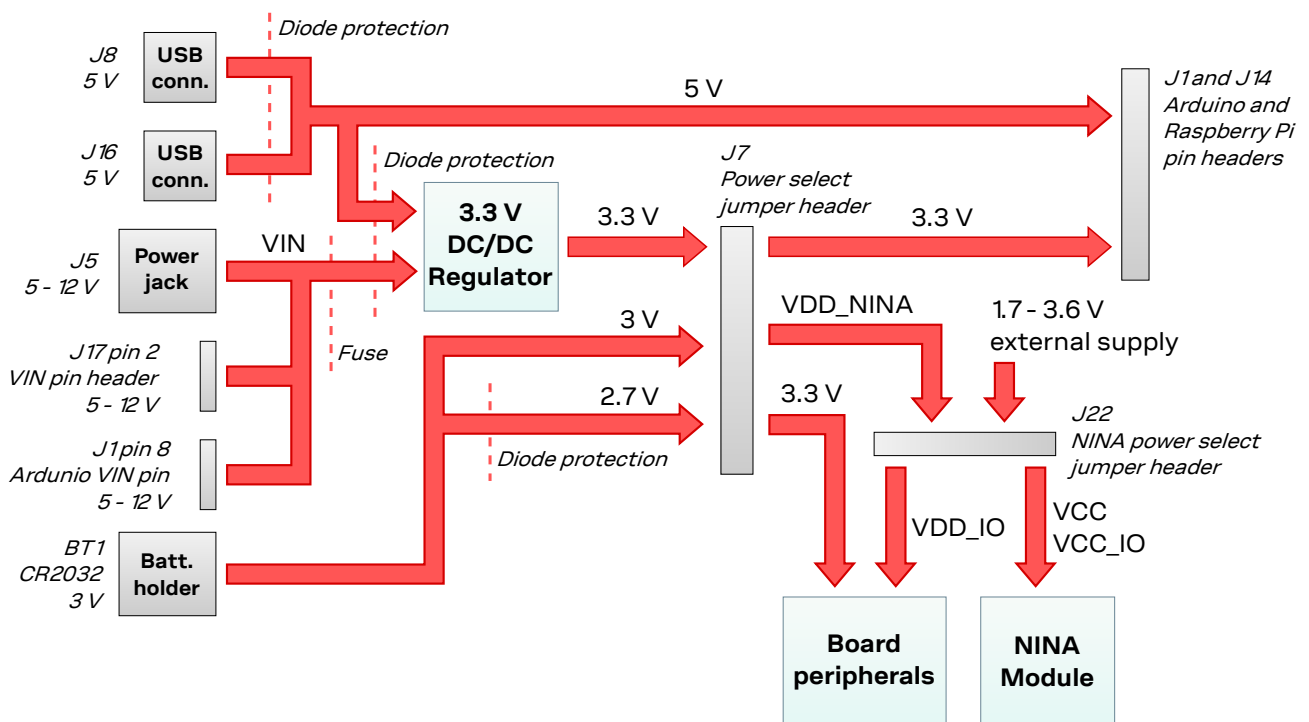

Figure 6: Block diagram of the power net distribution

4.1.1 Selecting the power configuration jumpers

EVK-NINA-B4 offers flexible powering options for the NINA-B4 module and the board itself. To configure this, jumpers are added or removed to pin headers, shorting two of the pins together and connecting or disconnecting different power nets on the evaluation board. Figure 7 shows an overview of the available power sources and targets. Figure 8 shows the location of the power configuration jumper headers.

- ⚠** Check the jumper positions carefully. If any jumper is connected in a wrong way, it can permanently damage the components that are ON or connected to the board. Note also that some jumpers should not be mounted simultaneously.

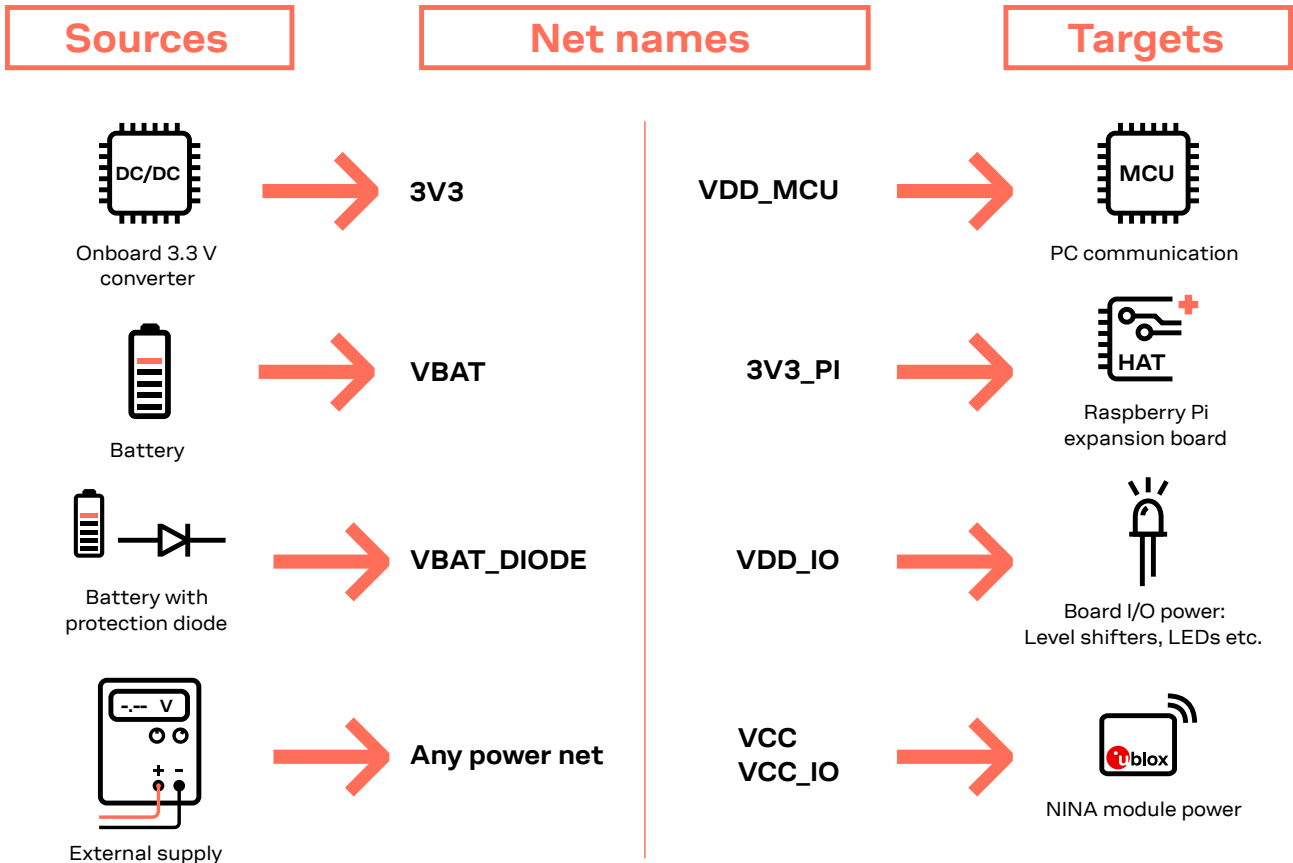

Figure 7: Overview of EVK power sources and targets showing connected schematic net names

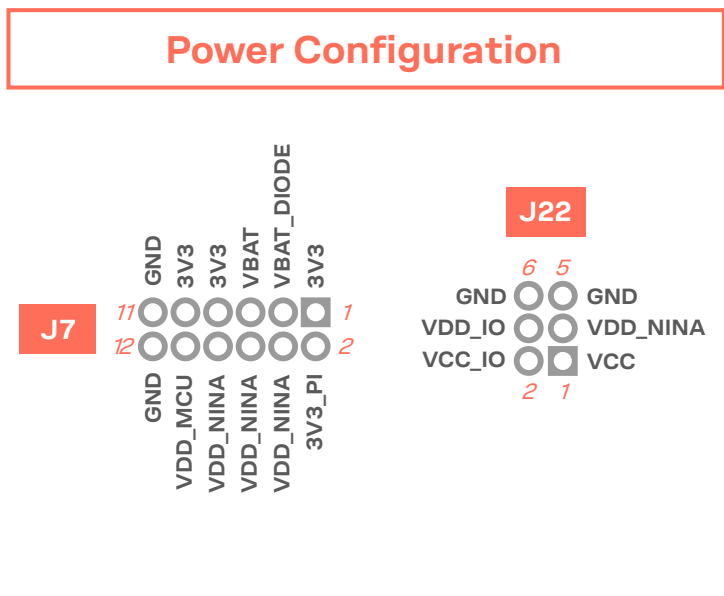
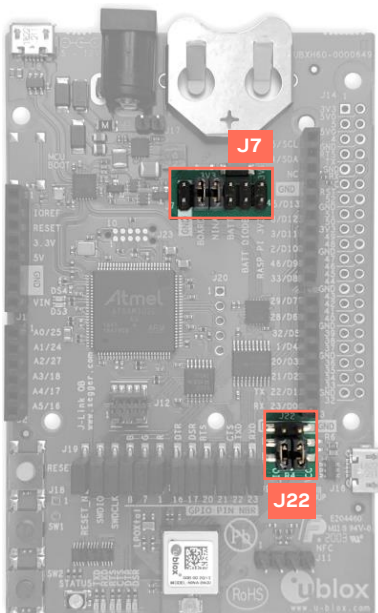

Figure 8: Jumper headers J7 and J22 board location and pinout

Connector	Pin no.	Schematic net	Description
J7	1	3V3	Regulated 3.3 V net. This net is supplied by the board and will always be powered as long as a power source is connected.
	2	3V3_PI	Connects to the Raspberry Pi header's (J14) 3V3 pins. If a Raspberry Pi is connected, this net must be unconnected to prevent back currents. If a HAT is connected, this net can be shorted to the EVK 3.3 V supply to power the HAT.
	3	VBAT_DIODE	To protect the battery from current back surges, connect the battery to the NINA module via a protection diode using this pin.
	4	VDD_NINA	Connects to J22 pin 3, from where it can be connected to the module supply pin or somewhere else.
	5	VBAT	Battery + terminal
	6	VDD_NINA	Connects to J22 pin 3, from where it can be connected to the module supply pin or somewhere else.
	7	3V3	Regulated 3.3 V net. This net is supplied by the board and will always be powered as long as a power source is connected.
	8	VDD_NINA	Connects to J22 pin 3, from where it can be connected to the module supply pin or somewhere else.
	9	3V3	Regulated 3.3 V net. This net is supplied by the board and will always be powered as long as a power source is connected.
	10	VDD_MCU	Supply net for the board functions not directly connected to the NINA module; Interface MCU, USB hub, UART to USB converter etc.
	11	GND	Ground net
	12	GND	Ground net
J22	1	VCC	NINA module voltage supply that connects to the module VCC pin. Shorted to the VCC_IO net via 0 Ω resistor R4 by default.
	2	VCC_IO	Connects to the NINA module VCC_IO pin. Shorted to the VCC net via 0 Ω resistor R4 by default.
	3	VDD_NINA	Connects to J7 pins 4, 6 and 8. Short J22 pins 1 and 3 allow the EVK to power the NINA module.
	4	VDD_IO	Supply net for level shifters, LEDs and peripherals connected directly to the NINA module. Short J22 pins 2 and 4 use the NINA module I/O voltage as supply.
	5	GND	Ground net
	6	GND	Ground net

Table 2: Pinout of jumper headers J7 and J22 used to configure the board power nets

4.1.2 Default power configuration, 3.3 V

This is the default power configuration for the evaluation board, and the jumpers are installed out-of-the-box with this power configuration. All board peripherals are powered up, the NINA module is directly supplied by the board, and everything is running at 3.3 V.

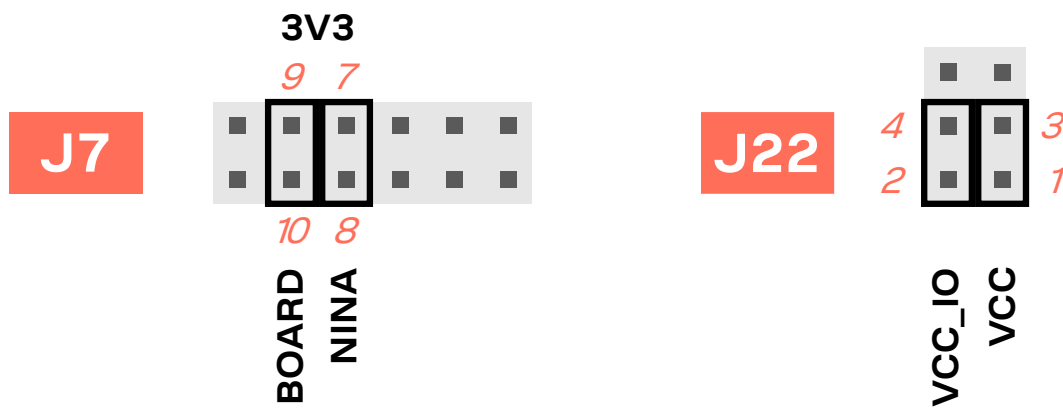
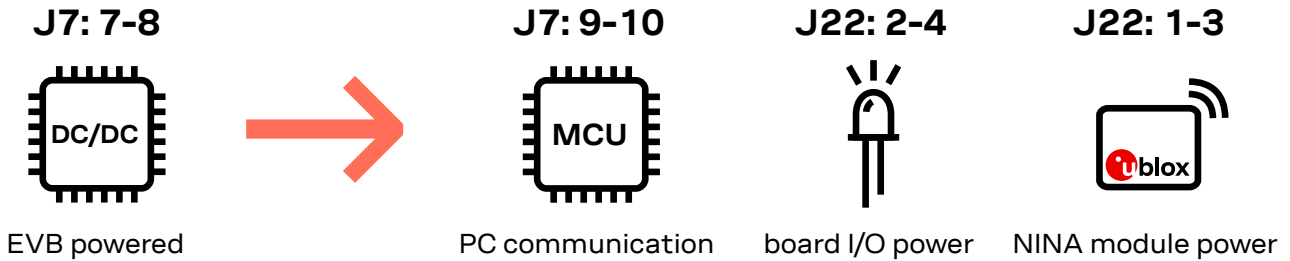



Figure 9: Jumper positions for default power configuration

Connector	Add jumper to pins	Description
J7	7, 8	Selects the board regulated 3.3 V net as source for the VDD_NINA net.
	9, 10	Powers up the Interface MCU, USB hub, and UART to USB converter with 3.3 V.
J22	1, 3	Powers up the NINA module. The NINA VCC and VCC_IO pins are connected to the selected source for the VDD_NINA net.
	2, 4	Powers up the peripherals directly connected to NINA such as LEDs and external memory with the NINA supply voltage.

Table 3: Jumper positions for default power configuration

4.1.3 Battery powered, 3–1.7 V

When using a battery, Figure 10 shows the default configuration. The battery voltage is connected to VDD_NINA, which in turn, is connected to the NINA-B4 VCC supply. If needed, a jumper can be added to J22 pins - 2 and 4 to supply LEDs and other peripherals with power, as long as this does not exceed the maximum current rating of the battery. If the NINA module has to be configured, the VDD_MCU net can be connected to enable PC communications by adding a jumper to J7 pins 9 and 10.

-  Jumpers must be connected to both J7: 9–10 and J22: 2–4 to be able to communicate with the NINA module from a PC. If possible, the EVB power configuration should be switched to the default 3.3 V configuration, as connecting an extra board peripheral might deplete the battery.
-  Do not connect jumpers J7: 5–6 and J7: 7–8 at the same time while a battery is connected. This might cause damage to the battery.

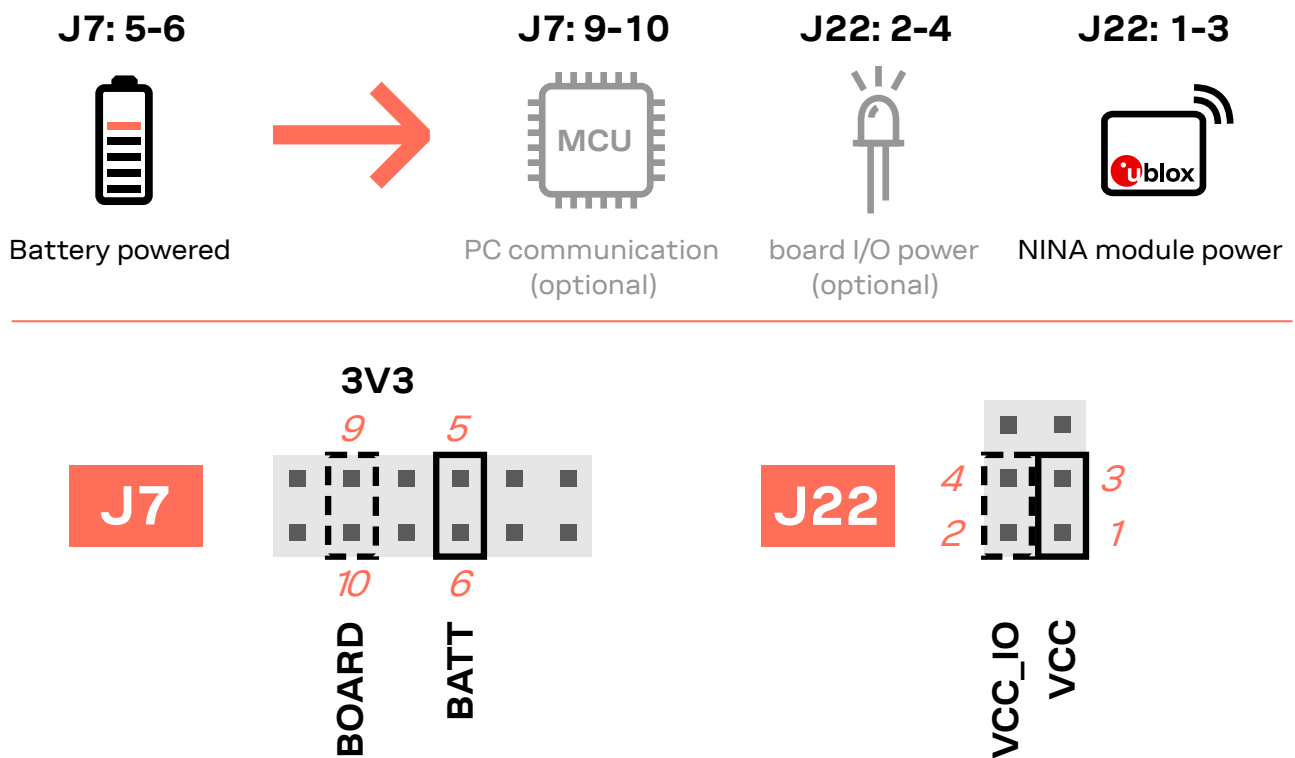

Figure 10: Jumper positions for battery powered operation, the jumpers shown in dashed lines are optional

Connector	Add jumper to pins	Description
J7	5, 6	Selects the battery connected to the battery holder as source for the VDD_NINA net.
	9, 10	(Optional) Powers up the Interface MCU, USB hub, and UART to USB converter with 3.3 V.
J22	1, 3	Powers up the NINA module. The NINA VCC and VCC_IO pins are connected to the selected source for the VDD_NINA net.
	2, 4	(Optional) Powers up the peripherals directly connected to NINA such as LEDs and external memory with the NINA supply voltage.

Table 4: Jumper positions for battery powered operation, two jumpers are optional

4.1.4 Battery powered with protection diode, 2.7–1.7 V

This use case is meant to protect the battery from current back surges. When using the NFC interface, there is a risk that the applied electromagnetic field can cause back surges on the module's power supply lines that will typically damage a non-chargeable battery. To prevent this damage, a Schottky diode is added in series to the battery, which will block any back current surges. A jumper should be added to J7 pins 3 and 4 instead of 5 and 6.

The diode will lower the voltage level of the battery by about 0.3 V.

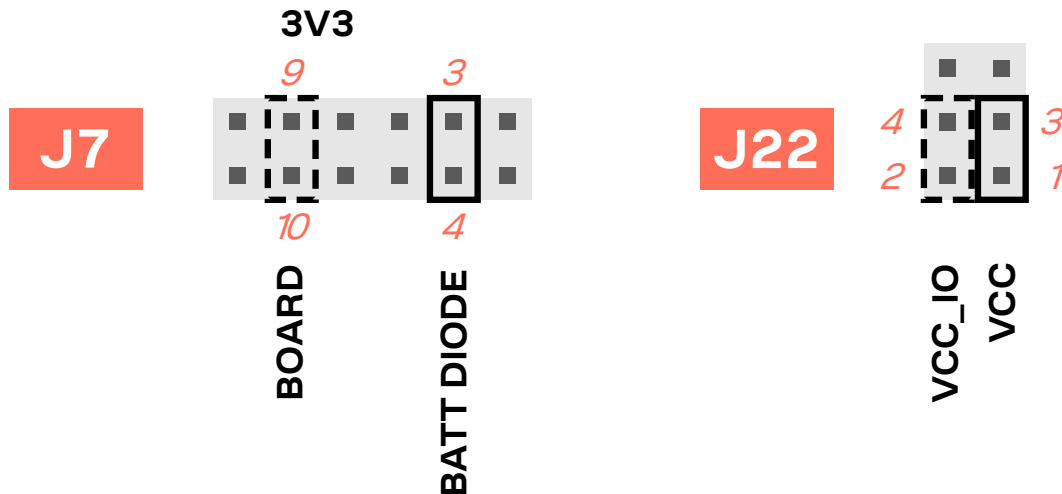
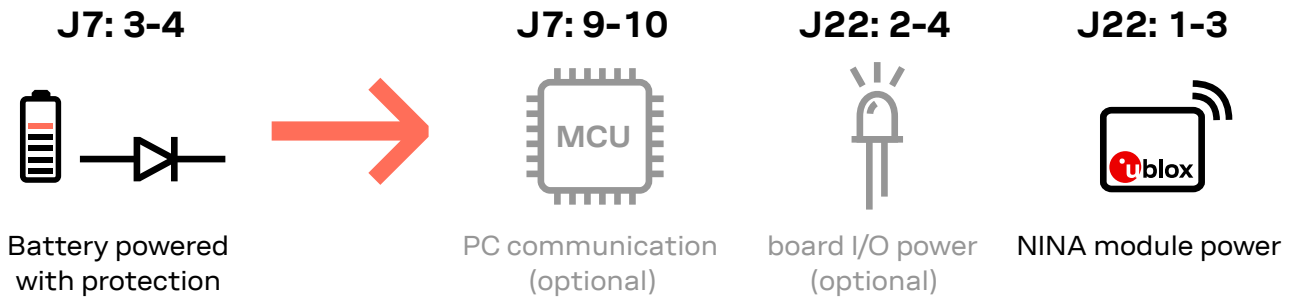

Figure 11: Jumper positions for battery powered operation with a protection diode (dashed lines show optional jumpers)

Connector	Add jumper to pins	Description
J7	3, 4	Selects the diode protected battery as a source for the VDD_NINA net.
	9, 10	(Optional) Powers up the Interface MCU, USB hub, and UART to USB converter with 3.3 V.
J22	1, 3	Powers up the NINA module. The NINA VCC and VCC_IO pins are connected to the selected source for the VDD_NINA net.
	2, 4	(Optional) Powers up the peripherals directly connected to NINA such as LEDs and external memory with the NINA supply voltage.

Table 5: Jumper positions for battery powered operation with a protection diode (with two optional jumpers)

4.1.5 External supply, 3.6–1.7 V

When measuring current consumption or performing other NINA-B4 module characterization measurements, it can be useful to power the module with an external source such as a lab power supply. In such cases, all jumpers can be removed and the required supply nets can be fed externally by connecting to the pin headers. For example, the NINA-B4 module can be powered by connecting an external supply directly to the J22 pin 1 and GND. See also [Using an external power supply or power analyzer](#).

- Make sure that unpowered parts of the board are properly isolated from the NINA module. If a voltage is applied to the signal of an unpowered device/component, current might leak through various protection circuits of this device. This might give false readings when measuring current consumption. Isolation can be achieved by removing NINA signal jumpers. See also [Disconnecting NINA signals from board peripherals](#).

Figure 12 below shows a few optional jumper connections that can be helpful when supplying the module with an external supply.

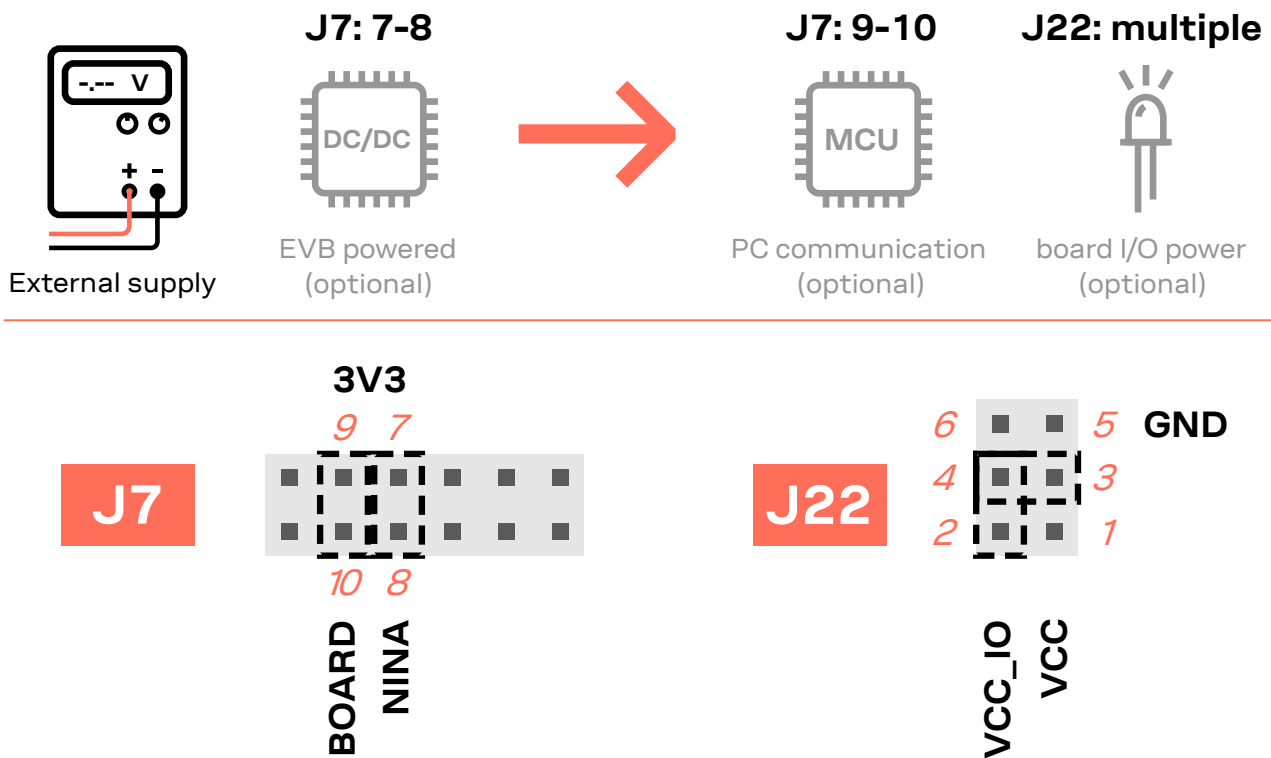

Figure 12: Optional jumper positions while using an external power supply

Connector	Add jumper to pins	Description
J7	7, 8	(Optional) Selects the board regulated 3.3 V net as a source for the VDD_NINA net.
	9, 10	(Optional) Powers up the Interface MCU, USB hub, and UART to USB converter with 3.3 V.
J22	3, 4	(Optional) Powers up the peripherals directly connected to NINA such as LEDs and external memory with the selected source for the VDD_NINA net.

Table 6: Optional jumper positions while using an external supply

4.1.6 Raspberry Pi HAT

When connecting a HAT to the Raspberry Pi interface, the following jumper configuration can be used. Depending on how the NINA module is to communicate with a test PC over USB or with the HAT, the **VDD_MCU** net could be left unpowered.

⚠ The **3V3_PI** supply net must only be powered when connecting to a Raspberry Pi expansion board (HAT). If connecting to a Raspberry Pi board, the jumper must be disconnected.

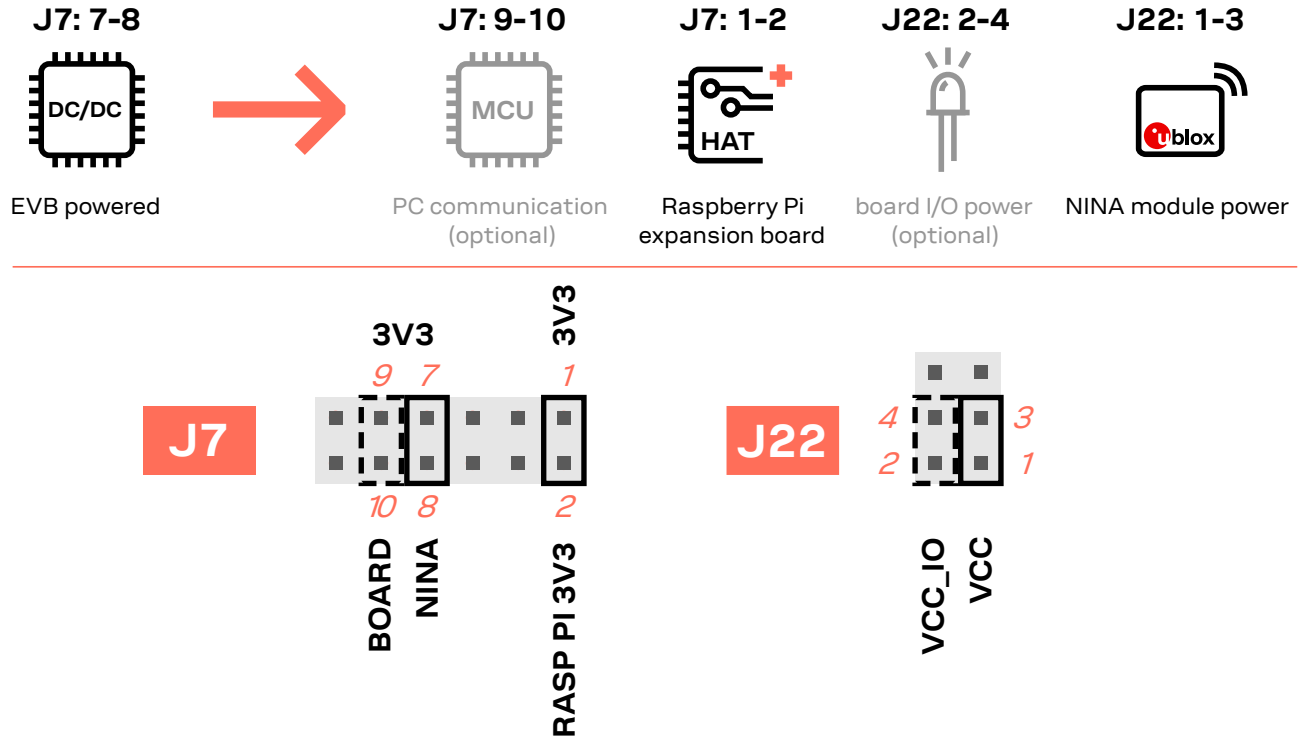

Figure 13: Jumper configuration when connected to a Raspberry Pi HAT (dashed lines show optional jumpers)

Connector	Add jumper to pins	Description
J7	1,2	Connects the 3V3_PI net to the regulated 3.3 V supply.
	7, 8	Selects the board regulated 3.3 V net as a source for the VDD_NINA net.
	9, 10	(Optional) Powers up the Interface MCU, USB hub, and UART to USB converter with 3.3 V.
J22	1, 3	Powers up the NINA module. The NINA VCC and VCC_IO pins are connected to the selected source for the VDD_NINA net.
	2, 4	(Optional) Powers up the peripherals directly connected to NINA such as LEDs and external memory with the NINA supply voltage.

Table 7: Jumper configuration when connected to a Raspberry Pi HAT

4.2 Disconnecting NINA signals from board peripherals

All evaluation board peripherals, such as level shifters, LEDs, and the interface MCU are connected to the NINA-B4 module by default. This might not suit all evaluation scenarios.

All peripherals can be switched off by disconnecting their power supplies (see also [Selecting the power configuration jumpers](#)) but finer control is needed to isolate specific signals. Consequently, all NINA module signals that are connected to board peripherals are routed through jumper headers. In this way, jumpers can be added or removed to isolate or connect specific signals. Figure 14 shows the layout of the jumper headers.

4.3 Connecting an external antenna (EVK-NINA-B410DF)

An antenna used for direction finding has many antenna elements that are controlled via an antenna switch. The antenna switch is controlled by several GPIOs on the EVK-NINA-B410DF. The antenna also needs to be fed with power and a ground connection from the EVK.

Presently only one antenna, CorePatch 8 from CoreHW [10], is supported by the u-connectLocate software. To use this antenna connect the antenna to the EVK-NINA-B410DF as described in Table 9.

EVK-NINA-B410DF	CoreHW antenna
D4	8 (ANT_SEL3)
D5	6 (ANT_SEL2)
D8	7 (ANT_SEL1)
D9	5 (ANT_SELO)
D12 or GND	9 (GND)
D13 or 3V3	10 (3V3)
3V3	1 and 2
GND	3 and 4

Table 9 Connections for external antenna

To configure the u-connectLocate software to use the external antenna, enter the following commands to EVK-NINA-B410DF:

```
AT+UDCFG=111,50
AT+UDCFG=107,"A1.1,A1.1,A1.1,A2.1,A3.1,A4.1,A5.1,A6.1,A7.1,A8.1,A1.1,A2.1,A3.1,A4.1,A5.1,A6.1,A7.1,A8.1,A1.2,A2.2,A3.2,A4.2,A5.2,A6.2,A7.2,A8.2,A1.2,A2.2,A3.2,A4.2,A5.2,A6.2,A7.2,A8.2"
AT+UDCFG=104,18
AT+UDCFG=106,1
AT+UDCFG=105,"core_patch"
AT&W
AT+CPWROFF
```

For other configuration possibilities, see also the Indoor direction finding XPLR-AOA-1 kit user guide [8].

5 Interfaces and peripherals

5.1 Buttons and LEDs

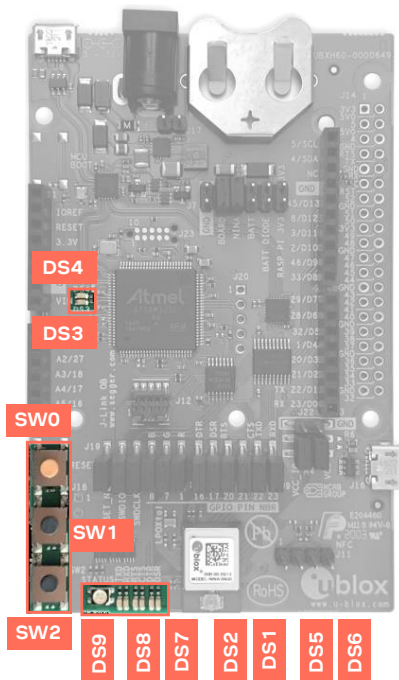

Buttons and LEDs

SW0	Reset	DS3	Interface MCU LED
SW1	User button	DS4	Interface MCU LED
SW2	User button	DS9	Status LED
		DS8	TXD LED
		DS7	RXD LED
		DS2	RTS LED
		DS1	CTS LED
		DS5	DTR LED
		DS6	DSR LED

Figure 15: Position of the push buttons and LEDs on the evaluation board

Annotation	Function	Description
SW0	Reset button	Connected directly to the NINA RESET_N pin.
SW1	User button	Push button for application use. Connected directly to the NINA SWITCH_1 (GPIO_7) pin
SW2	User button	Push button for application use. Connected directly to the NINA SWITCH_2 (GPIO_18) pin.

Table 10: EVK-NINA-B4 buttons

Annotation	Function	Description	Color
DS1	UART CTS LED	Connected to the NINA UART_CTS (GPIO_21) pin via jumper header J9	
DS2	UART RTS LED	Connected to the NINA UART_RTS (GPIO_20) pin via jumper header J9	
DS3	Interface MCU LED	Blinks on USB enumeration and activity, lit when the Interface MCU is connected via USB	
DS4	Interface MCU LED	Error LED	
DS5	UART DTR LED	Connected to the NINA UART_DTR (GPIO_16) pin via jumper header J9	
DS6	UART DSR LED	Connected to the NINA UART_DSR (GPIO_17) pin via jumper header J9	
DS7	UART TXD LED	Connected to the NINA UART_TXD (GPIO_22) pin via jumper header J9	
DS8	UART RXD LED	Connected to the NINA UART_RXD (GPIO_23) pin via jumper header J9	
DS9	RGB LED	Connected to the NINA RED (GPIO_1), GREEN (GPIO_7) and BLUE (GPIO_8) pins via jumper header J19. The RGB LED shows the status for the u-connect applications.	



See also the NINA-B4 data sheet [3].

Table 11: EVK-NINA-B4 LED indicators

5.2 Arduino interface

The EVK-NINA-B4 includes a set of pin headers and mounting holes that are compatible with certain Arduino or Arduino inspired shields.

Figure 16 shows the layout of the Arduino interface described in Table 12. See also [Arduino shield compatibility](#) for information about compatible shields for EVK-NINA-B4.

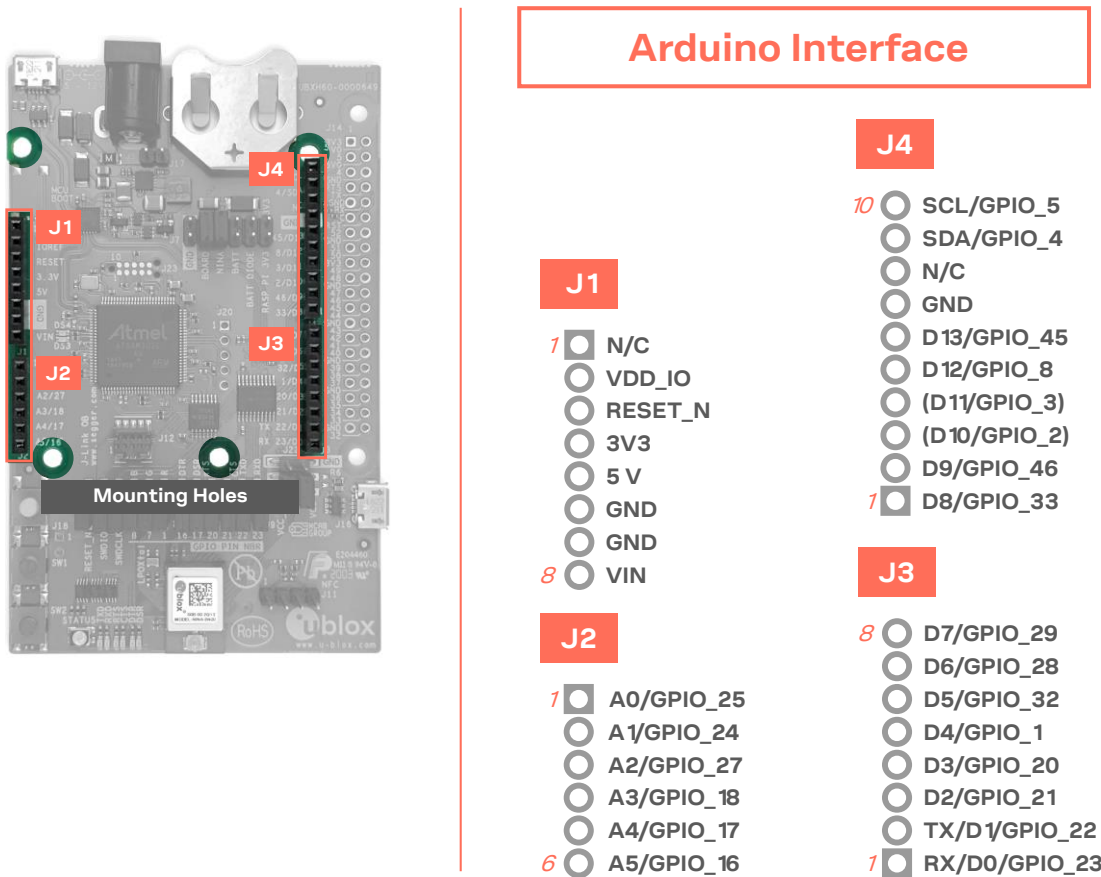



Figure 16: Pin headers that are compatible with some Arduino shields

Conn.	Pin No.	Arduino pin	Description	Schematic net name	nRF52 pin	Alternate functions and notes
J1	1	N/C	Not Connected	-	-	Not connected
	2	IOREF	I/O reference voltage level. Selectable by user to 1.7 – 3.6 V	VDD_IO	-	See also Selecting the power configuration jumpers
	3	RESET	NINA reset signal input. Active low logic	RESET_N	P0.18	
	4	3.3V	3.3 V DC regulated supply output	3V3	-	
	5	5V	5 V regulated supply output	5V	-	Cannot be used as supply input, use VIN instead. Only supplied by USB VBUS.
	6	GND	Ground	GND	GND	
	7	GND	Ground	GND	GND	
	8	VIN	External DC supply input, 5 – 12 VDC	VIN	-	

Conn.	Pin No.	Arduino pin	Description	Schematic net name	nRF52 pin	Alternate functions and notes
J2	1	A0	Analog input	GPIO_25	P0.04	Analog function capable GPIO
	2	A1	Analog input	GPIO_24	P0.30	Analog function capable GPIO
	3	A2	Analog input	GPIO_27	P0.05	Analog function capable GPIO
	4	A3	Analog input	SWITCH_2/ GPIO_18	P0.02	Analog function capable GPIO, SWITCH_2 on NINA-B41. This signal is pulled low when the button SW2 is pressed
	5	A4	Analog input	UART_DSR/ GPIO_17	P0.28	Analog function capable GPIO, UART_DSR signal on NINA-B41
	6	A5	Analog input	UART_DTR/ GPIO_16	P0.03	Analog function capable GPIO, UART_DTR signal on NINA-B41
J3	1	D0/RX	Digital I/O, UART RX	UART_RXD/ GPIO_23	P0.29	UART_RXD signal on NINA-B41
	2	D1/TX	Digital I/O, UART TX	UART_TXD/ GPIO_22	P1.05	UART_TXD signal on NINA-B41
	3	D2	Digital I/O	UART_CTS/ GPIO_21	P0.23	UART_CTS signal on NINA-B41
	4	D3	Digital I/O	UART_RTS/ GPIO_20	P0.31	UART_RTS signal on NINA-B41
	5	D4	Digital I/O	GPIO_1	P0.13	
	6	D5	Digital I/O	GPIO_32	P0.11	
	7	D6	Digital I/O	GPIO_28	P0.09	Signal not connected by default.- Configured for NFC use.
	8	D7	Digital I/O	GPIO_29	P0.10	Signal not connected by default.- Configured for NFC use.
J4	1	D8	Digital I/O	GPIO_33	P1.09	
	2	D9	Digital I/O	GPIO_46	P0.12	
	3	D10	Digital I/O	GPIO_2	P0.00	Disconnected by default Connected to 32Khz LPO Xtal. To connect GPIO 2 to J4 header instead of LPO Xtal, remove R66 and add R64 (zero ohm resistor)
	4	D11	Digital I/O	GPIO_3	P0.01	Disconnected by default Connected to 32Khz LPO Xtal. To connect GPIO 3 to J4 header instead of LPO Xtal, remove R67 and add R65 (zero ohm resistor)
	5	D12	Digital I/O	GPIO_8	P1.00	
	6	D13	Digital I/O	GPIO_45	P0.07	
	7	GND	Ground	GND		
	8	AREF	Analog reference voltage level	-	-	Not connected
	9	SDA	I2C data signal	GPIO_4	P0.16	
	10	SCL	I2C clock signal	GPIO_5	P0.17	

Table 12: Pinout of the Arduino UNO R3 compatible interface

5.2.1 Arduino shield compatibility

 As EVK-NINA-B4 has an I/O voltage range of 1.7–3.6 V, it can only be used with shields that support an I/O voltage in this range.

The EVK-NINA-B4 has a pinout that is compatible with some Arduino, or Arduino-inspired, shields.

The characteristics of certain EVK pins demand that shields support the following features:

- IOREF: The I/O voltage level of the NINA-B4 module is 3.3 V by default, but the EVK can be modified to allow other voltages (1.7–3.6 V).
- RESET: Is connected to the RESET button (SW0).
- 3.3 V: A regulated 3.3 V output. Should not be used as a voltage supply input, use the VIN pin instead.
- 5 V: Is only a 5 V supply output if the EVK is being powered by USB. If any other power configuration is used, this pin will be unconnected (floating). It is safe to connect an external 5 V supply to this pin even when a USB cable is connected. This pin may be used to power the board.
- VIN: May be used as a 5–12 V supply input to power the EVK-NINA-B4.
- Pin 0 (RX): Is connected to the NINA-B4 UART RX pin (NINA pin 23).
- Pin 1 (TX): Is connected to the NINA-B4 UART TX pin (NINA pin 22).

 **SCL/SDA:** On some Arduino boards, the I2C signals, SCL, and SDA are connected to pins A4 and A5 and to the SCL and SDA pins in the top right-hand corner. Since these pins will be shorted together, this might cause problems when they are connected to the EVK-NINA-B4 – in which they are not normally shorted.

 **Digital I/O pins:** For serial communication and flashing/debugging over USB, some digital I/O pins can be connected to the on-board debug MCU. In these instances, the connected pins can cause some interference on the signals that are also used by an Arduino shield. See also [Disconnecting NINA signals from board peripherals](#).

5.3 Raspberry Pi compatible interface

The EVK-NINA-B4 includes a 40-pin GPIO header that can be used to interface with either a Raspberry Pi computer board or Raspberry Pi Hardware Attached on Top (HAT) expander. EVK-NINA-B4 uses different hardware and software configurations depending on whether it is connected to a Pi or HAT. The default configuration is for connection to a P computer board. Compatible Raspberry Pi versions are described in Table 13 .

 Older Pi and HAT versions that do not use a 40-pin GPIO header are not supported.

Compatible Raspberry Pi boards

Raspberry Pi 1 Model A+

Raspberry Pi 1 Model B+

Raspberry Pi 2 Model B

Raspberry Pi 3 Model B

Raspberry Pi Zero

Raspberry Pi Zero W

Table 13: Compatible Raspberry Pi boards

Figure 17 shows the layout of the Raspberry Pi interface described in Table 14. Three mounting holes can be used for increasing the mechanical stability. The two holes on each side of connector J14 are common to all Raspberry Pi boards, but the third one is only compatible with the Pi Zero boards.

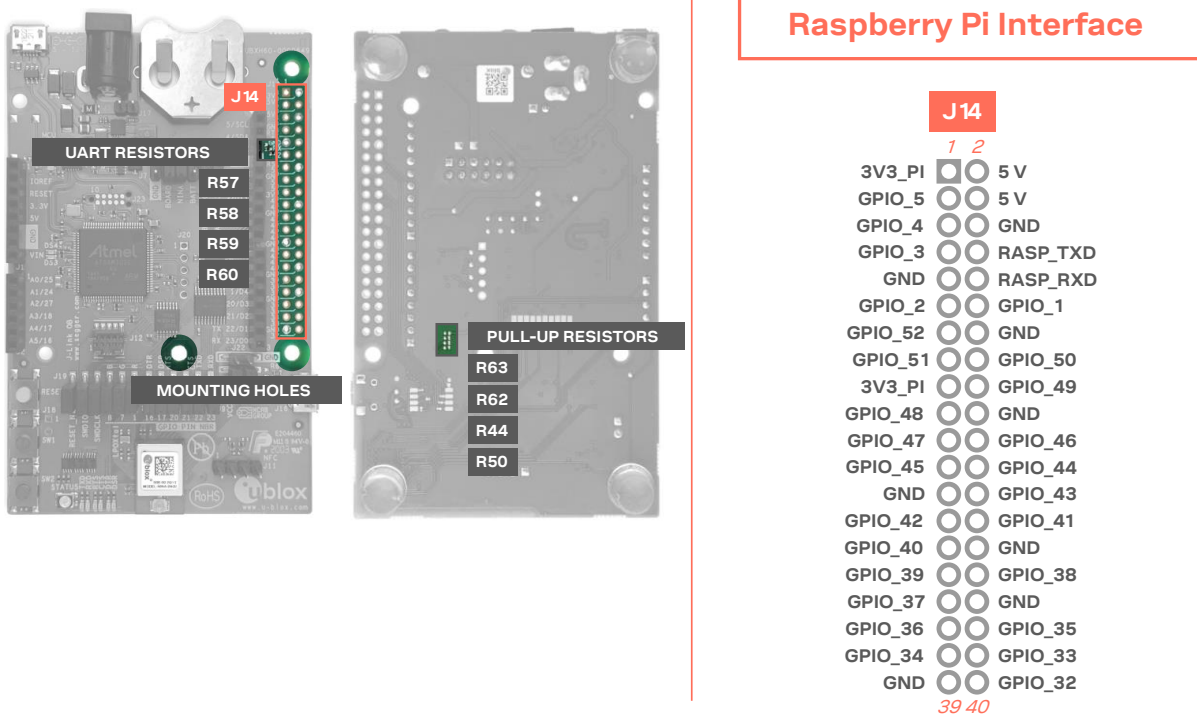

Figure 17: Pin header J14 that is compatible with the Raspberry Pi GPIO connectors

Conn.	Pin No.	Raspberry Pi pin	Description	Schematic net name	nRF52 pin	Alternate functions and notes
J14	1	3.3 V	3.3 V supply pin	3V3_PI	-	Not connected by default. See also Powering options .
	2	5 V	5 V supply pin	5V	-	Cannot be used as supply input. Supplied by USB VBUS and protected from back powering.
	3	GPIO02	Digital I/O	GPIO_5	P0.17	
	4	5 V	5 V supply pin	5V	-	Cannot be used as supply input. Supplied by USB VBUS and protected from back powering.
	5	GPIO03	Digital I/O	GPIO_4	P0.16	
	6	GND	Ground	GND	GND	
	7	GPIO04	Digital I/O	GPIO_3	P0.01	Disconnected by default Connected to 32Khz LPO clock. To connect GPIO 3 to J4 header instead of LPO clock, remove R67 and add R65 (zero ohm resistor)
	8	GPIO14	Digital I/O, UART TX/RX	RASP_TXD	P0.29	Connected to NINA UART_RXD pin by default. See also UART .
	9	GND	Ground	GND	GND	
	10	GPIO15	Digital I/O, UART RX/TX	RASP_RXD	P1.05	Connected to NINA UART_TXD pin by default. See also UART .
	11	GPIO17	Digital I/O	GPIO_2	P0.00	Disconnected by default

Conn.	Pin No.	Raspberry Pi pin	Description	Schematic net name	nRF52 pin	Alternate functions and notes
						Connected to 32Khz LPO clock. To connect GPIO 2 to J4 header instead of LPO clock, remove R66 and add R64 (0 Ω resistor)
	12	GPIO18	Digital I/O	GPIO_1	P0.13	
	13	GPIO27	Digital I/O	GPIO_52	P0.08	Connected to NINA through a solder bridge, if the solder bridge is cut this pin will be left floating
	14	GND	Ground	GND	GND	
	15	GPIO22	Digital I/O	GPIO_51	P1.08	Connected to NINA through a solder bridge, if the bridge is cut this pin will be left floating
	16	GPIO23	Digital I/O	GPIO_50	P0.20	Connected to NINA through a solder bridge, if the bridge is cut this pin will be left floating
	17	3.3 V	3.3 V supply pin	3V3_PI	-	Not connected by default. See also Powering options
	18	GPIO24	Digital I/O	GPIO_49	P0.22	Connected to NINA through a solder bridge, if the bridge is cut this pin will be left floating
	19	GPIO10	Digital I/O	GPIO_48	P0.21	Connected to NINA through a solder bridge, if the bridge is cut this pin will be left floating
	20	GND	Ground	GND	GND	
	21	GPIO09	Digital I/O	GPIO_47	P0.06	Connected to NINA through a solder bridge, if the bridge is cut this pin will be left floating
	22	GPIO25	Digital I/O	GPIO_46	P0.12	
	23	GPIO11	Digital I/O	GPIO_45	P0.07	
	24	GPIO08	Digital I/O	GPIO_44	P0.27	
	25	GND	Ground	GND	GND	
	26	GPIO07	Digital I/O	GPIO_43	P0.15	
	27	ID_SD	EEPROM config I2C data signal	GPIO_42	P0.26	Should only be used to read or simulate HAT EEPROMs. See also EEPROM support .
	28	ID_SC	EEPROM config I2C clock signal	GPIO_41	P1.03	Should only be used to read or simulate HAT EEPROMs See also EEPROM support .
	29	GPIO05	Digital I/O	GPIO_40	P0.19	
	30	GND	Ground	GND	GND	
	31	GPIO06	Digital I/O	GPIO_39	P1.07	
	32	GPIO12	Digital I/O	GPIO_38	P0.25	
	33	GPIO13	Digital I/O	GPIO_37	P1.06	
	34	GND	Ground	GND	GND	
	35	GPIO19	Digital I/O	GPIO_36	P1.02	
	36	GPIO16	Digital I/O	GPIO_35	P1.04	
	37	GPIO26	Digital I/O	GPIO_34	P0.14	
	38	GPIO20	Digital I/O	GPIO_33	P1.09	
	39	GND	Ground	GND	GND	
	40	GPIO21	Digital I/O	GPIO_32	P0.11	

Table 14: Pinout of the Raspberry Pi compatible interface

5.3.1 Powering considerations

Two voltage nets are used in the Raspberry Pi interface, **3V3_PI** and **5V**. Both the **3V3_PI** and **5V** nets can be used to power HATs, but these nets should not be used when connecting to a Raspberry Pi. See also [Raspberry Pi HAT](#).

-  Do not connect the **3V3_PI** power net to the 3.3 V supply when connected to a Raspberry Pi board. Failure to do so can cause serious damage to both boards.

5.3.2 UART

The Raspberry Pi interface provides two pins that can be used for UART communications **GPIO14** and **GPIO15**.

In UART communications, signals are always connected RX <-> TX and vice versa. This means that **GPIO14** is TX on a Raspberry Pi board, but RX and on a HAT. To support communication with both HATs and Pi boards, the zero Ω resistors (R57, R58, R59 and R60) can be used to toggle the NINA TX and RX pins between **GPIO14** and **GPIO15**. If a NINA-B40 is used, this switch can also be made in the software. By default, the EVK-NINA-B4 is configured to simulate a HAT, with **GPIO14** connected to the NINA **UART_RXD** pin and **GPIO15** connected to the NINA **UART_TXD** pin.

5.3.3 EEPROM support

The Raspberry Pi interface supports a unique EEPROM solution that stores the HAT specific GPIO configurations on the HAT board. The Raspberry Pi reads the configurations before configuring its GPIOs. The two pins used for this, **ID_SD** and **ID_SC**, are connected to the NINA-B4 module. In this way, the NINA module can either read the GPIO configuration from a HAT or simulate an EEPROM and send configurations to a connected Pi. This requires a NINA-B40 module and a custom-built application.

The EEPROM solution is not mandatory. If this approach considered inappropriate, do not configure **GPIO_42** and **GPIO_41**.

Two pull-up resistors, R44 and R50, can be added to the I2C lines if needed. These pins are not mounted on the evaluation board by default.

For more information on the ID EEPROM specification, see the [raspberrypi/hats](#) pages at github.

5.4 Additional Interfaces

In addition to the normal interfaces most commonly used, there are several other few expansion options available to the user. These extra interfaces require some modifications to the EVB before they can be used.

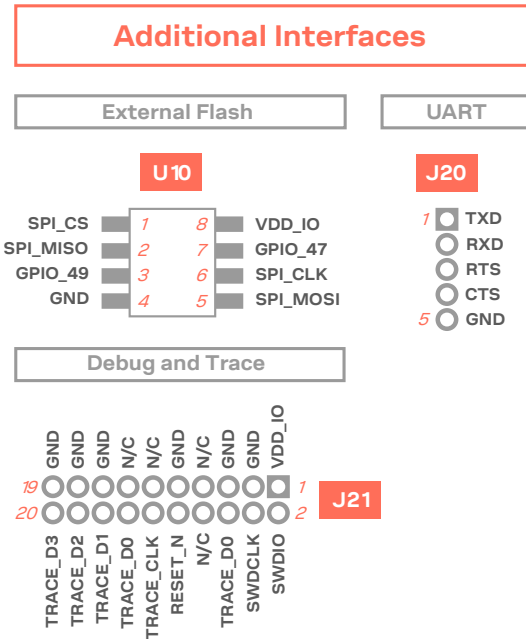
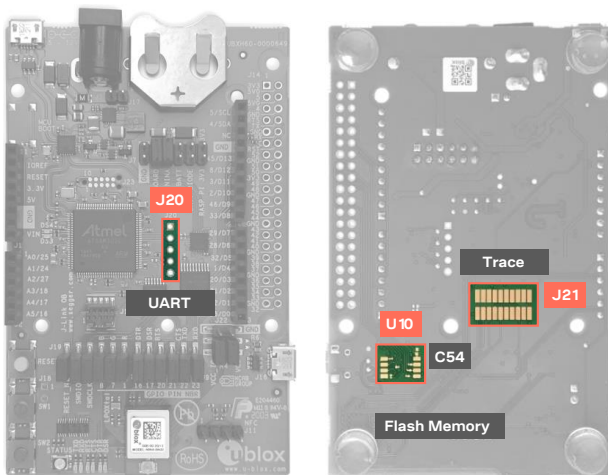
Figure 18: Additional interfaces that require some soldering before use

Connector annotation	Pin number	Schematic net name	nRF52 pin	Description
U10	1	SPI_CS/GPIO_51	P1.08	Chip select input signal, active low
	2	SPI_MISO/GPIO_48	P0.21	MISO in single SPI mode, or data I/O signal in dual/quad mode
	3	GPIO_49	P0.22	
	4	GND	GND	Ground
	5	SPI_MOSI/GPIO_50	P0.20	MOSI in single SPI mode, or data I/O signal in dual/quad mode
	6	SPI_CLK/GPIO_52	P0.08	Chip clock input signal, up to 32 MHz supported
	7	GPIO_47	P0.06	
	8	VDD_IO	-	Supply net for LEDs and peripherals connected directly to the NINA module. Supply for the external memory chip.
J20	1	MCU_TXD	-	Interface MCU data output signal
	2	MCU_RXD	-	Interface MCU data input signal
	3	MCU_RTS	-	Interface MCU flow control output signal
	4	MCU_CTS	-	Interface MCU flow control input signal
	5	GND	GND	Ground
J21	1	VDD_IO	-	Supply net for LEDs and peripherals connected directly to the NINA module. Supply for the external memory chip.
	2	SWDIO	SWDIO	Serial Wire Debug data I/O signal
	3	GND	GND	Ground
	4	SWDCLK	SWDCLK	Serial Wire Debug clock signal
	5	GND	GND	Ground
	6	TRACE_D0/SWO/ GPIO_8	P1.00	Serial trace data signal / Parallel trace data signal
	7	N/C	-	Not connected
	8	N/C	-	Not connected
	9	GND	GND	Ground
	10	RESET_N	P0.18	NINA reset signal, active low

Connector annotation	Pin number	Schematic net name	nRF52 pin	Description
	11	N/C	-	Not connected
	12	TRACE_CLK/GPIO_45	P0.07	Parallell trace clock signal
	13	N/C	-	Not connected
	14	TRACE_D0/SWO/GPIO_8	P1.00	Serial trace data signal / Parallell trace data signal
	15	GND	GND	Ground
	16	TRACE_D1/GPIO_46	P0.12	Parallell trace data signal
	17	GND	GND	Ground
	18	TRACE_D2/GPIO_32	P0.11	Parallell trace data signal
	19	GND	GND	Ground
	20	TRACE_D3/GPIO_33	P1.09	Parallell trace data signal

Table 15: Pinout of the additional interfaces

5.4.1 Extra memory – external Flash

NINA-B4 series modules support can accommodate extra memory outside of the module. The memory space can be used to store data and/or expand the application code size.

NINA-B4 modules support an SPI (Serial Peripheral Interface) to communicate with the external flash memory. For information about the supported modes, clock frequencies and other features of the SPI, see the NINA-B4 series Data sheet [1].

SPI signals are shared with other interfaces and GPIO functions and are routed to the GPIO pin header J14 (Raspberry Pi interface) and flash memory footprint on the bottom side of the evaluation board. To reduce the risk of interference on the SPI, solder bridges have been added to the signal lines. Before soldering the flash memory to the board, the solder bridges must be cut to isolate the copper traces routed to J14. Figure 19 shows where to cut the bridges.

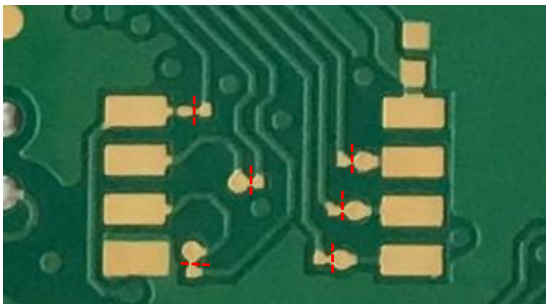

Figure 19: Cut these solder bridges before soldering the external memory

The board outline is designed with a footprint for SOIC-8 packages with 5.3 mm body width. The smaller footprint above this can accommodate a 0402 sized ~100 nF decoupling capacitor, which is recommended to stabilize the memory supply.

5.4.2 Extra USB to UART interface

If the evaluation board is connected to a PC using the USB connector J8, two serial COM ports are available. The COM port labeled “JLink CDC UART” (on a Windows PC) is not normally connected to anything but is instead routed as a 4-pin UART interface to the pin header J20. This interface could be connected to a secondary UART interface on the NINA-B4 module, or to a UART interface on an Arduino shield for example.

5.4.3 CPU trace interface

The Arm Cortex-M4F processor in NINA-B4 modules supports tracing of CPU instructions through the 20-pin, 50 mil pitch, Cortex Debug + ETM connector. This extended connector has the same features as J12, but also accommodates instruction trace operations through the Embedded Trace Macrocell (ETM) of the Cortex-M4 microcontroller in the NINA-B4 module. Tracing instructions through this connector requires a special external debugger.

 Note that the 50 mil pitch pin header is not soldered onto the evaluation board by default.

Appendix

A Schematics

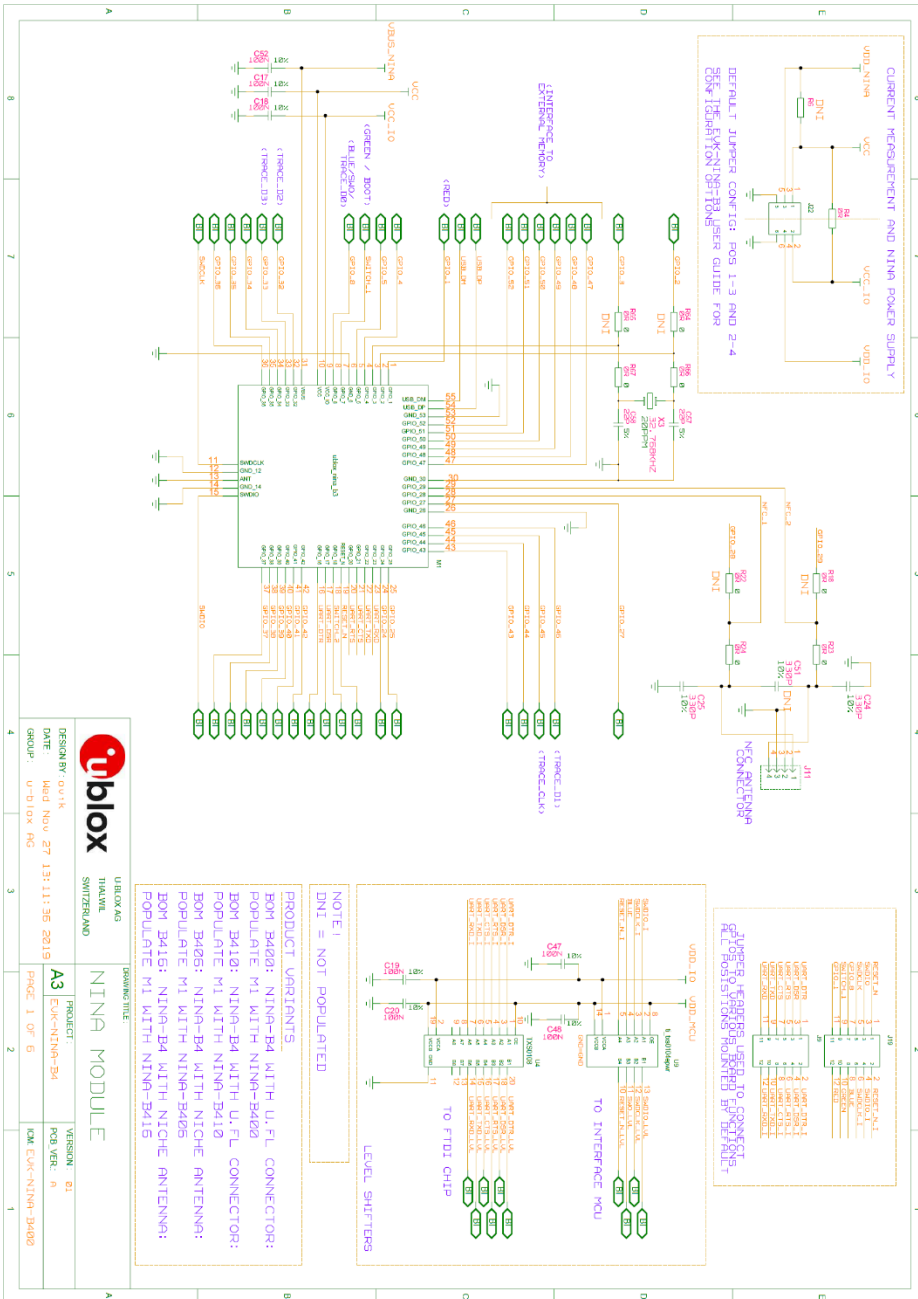

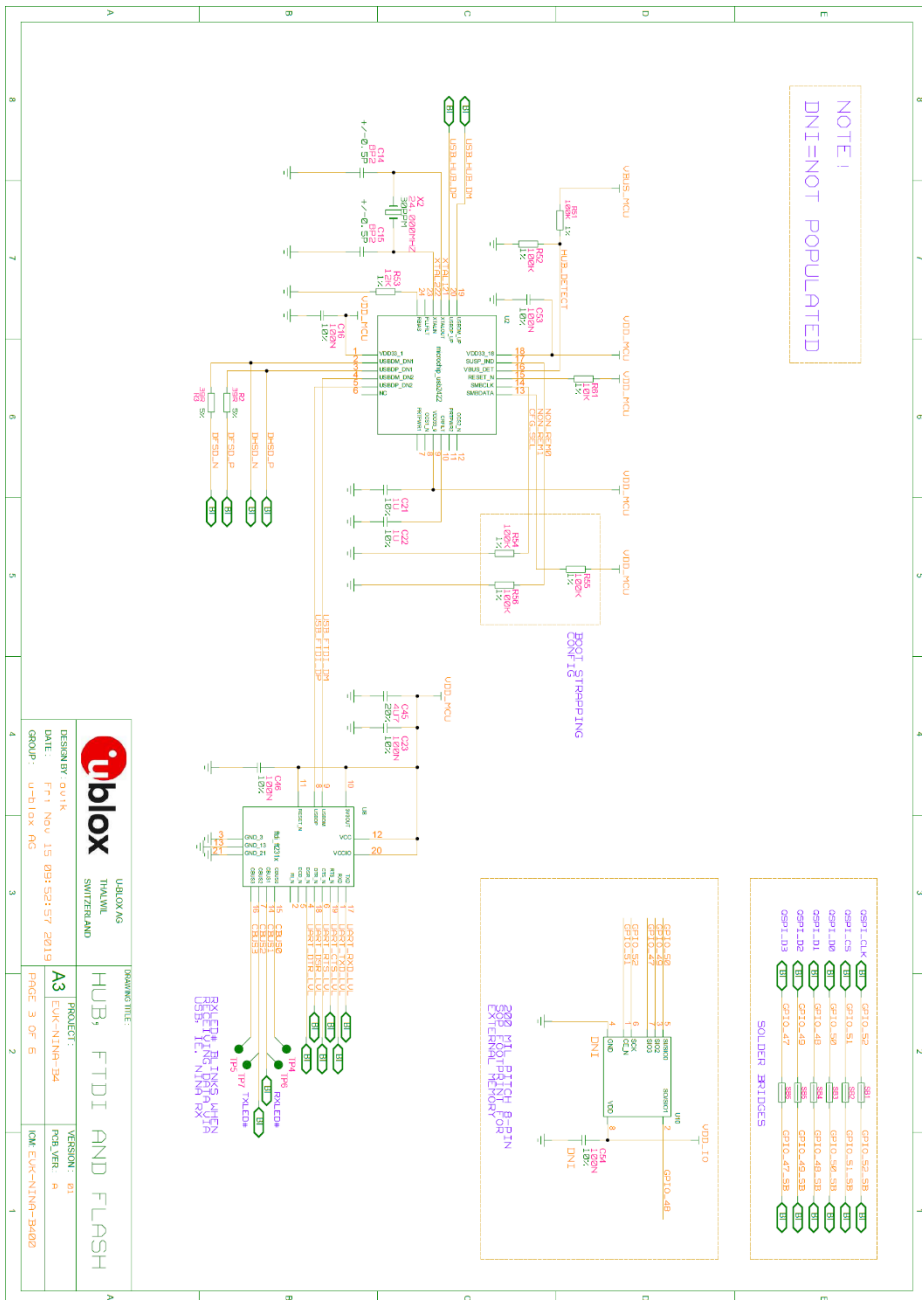

		UBXOXMG THALWE SWITZERLAND	
DRAWING TITLE: HUB, FTDI AND FLASH		PROJECT: EVK-NINA-B4	
DESIGNER: DUTK	DATE: 17.11.2019	VERSION: 01	PUBLISHED: A
GROUP: U-Blox RG	DATE: 15.08.2019	PRICE: 3 OF 6	ICM: EVK-NINA-B400

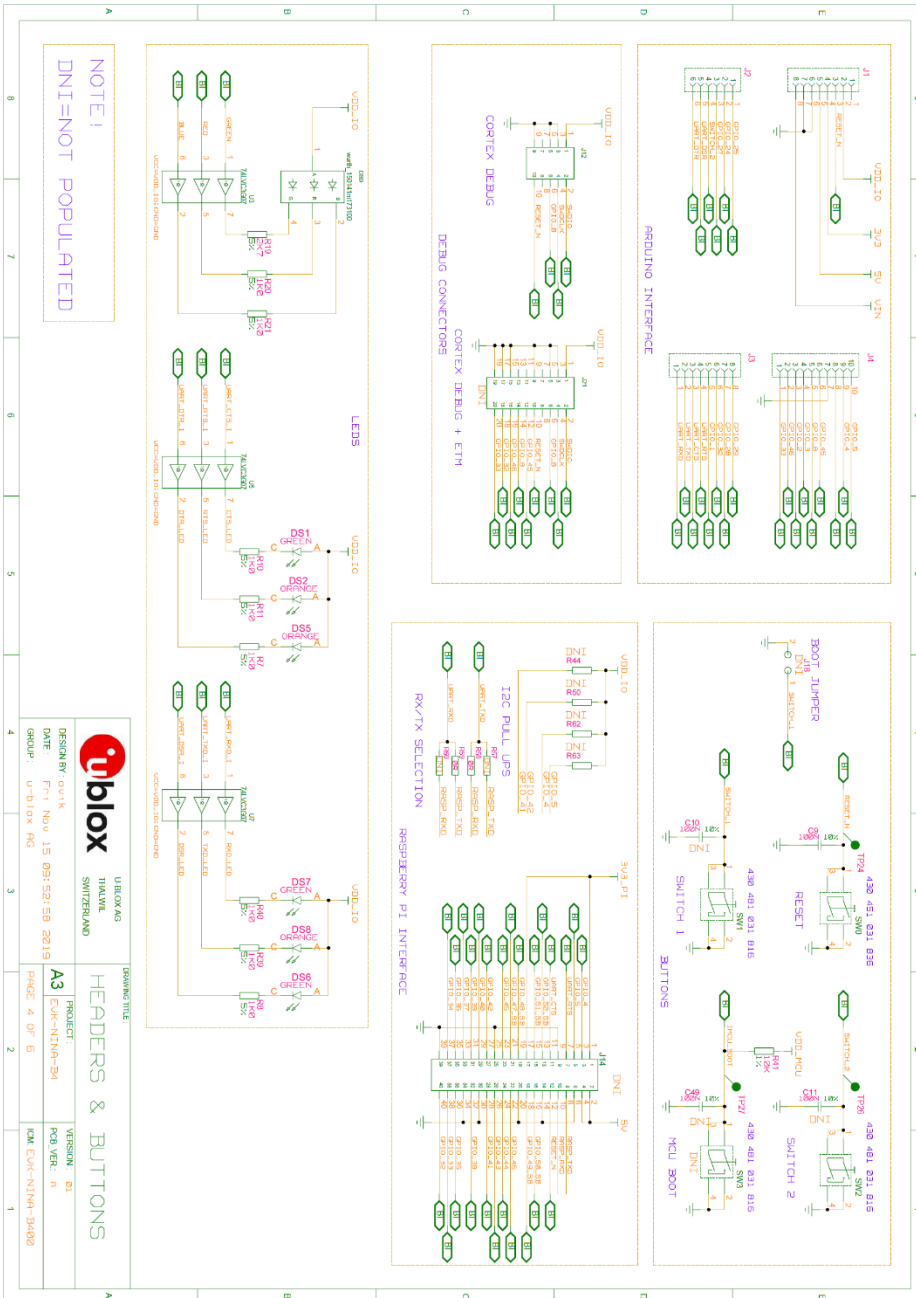

For the first prototype build (marked PT1) EVK-NINA-B3 schematic can be used as a reference.

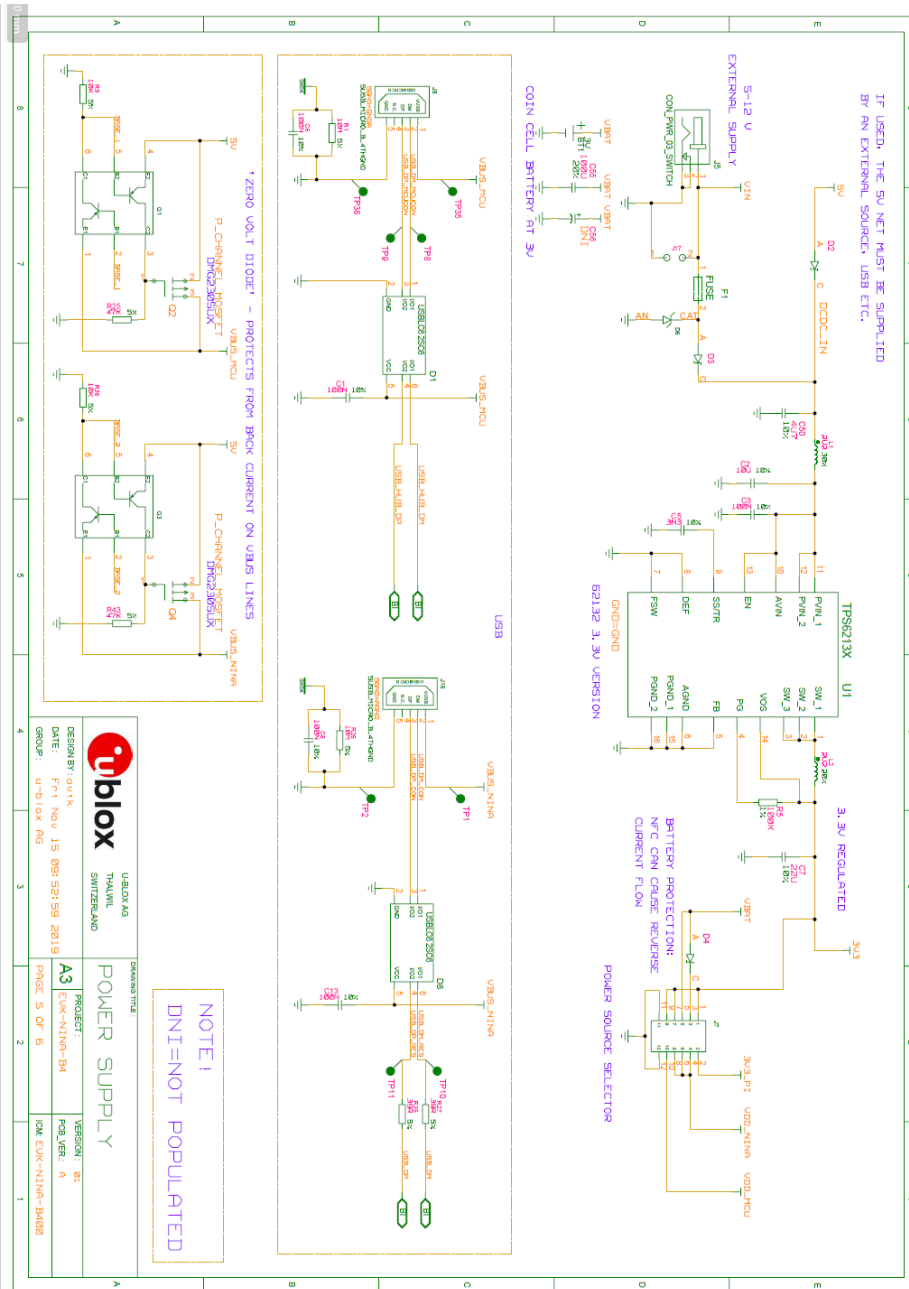

- For the first prototype build (marked PT1) EVK-NINA-B3 schematic can be used as a reference.
- Pages 2 and 6 of the schematic are intentionally omitted.

B Glossary

Abbreviation	Definition
API	Application programming interface
CTS	Clear To send
EVK	Evaluation kit
GND	Ground
GPIO	General-Purpose Input/Output
LED	Light-Emitting Diode
MCU	Micro controller unit
MSD	Mass storage device
NFC	Near Field Communication
U.FL	Coaxial RF connector
USB	Universal serial bus
RTS	Request To send
SDK	Software development kit
SOIC	Small outline integrated circuit
SPA	Serial port application
UART	Universal Asynchronous Receiver/Transmitter

Table 16: Explanation of the abbreviations and terms used

Related documents

- [1] Arduino – <https://www.arduino.cc>
- [2] Raspberry Pi - <https://www.raspberrypi.org/>
- [3] NINA-B4 data sheet, [UBX-19049405](#)
- [4] NINA-B4 series system integration manual, [UBX-19052230](#)
- [5] u-blox Short range AT commands manual, [UBX-14044127](#)
- [6] SEGGER J-Link software - <https://www.segger.com/jlink-software.html>
- [7] u-connectXpress user guide, [UBX-16024251](#)
- [8] Indoor direction finding XPLR-AOA-1 kit user guide, [UBX-21004616](#)
- [9] U-blox open CPU repository: <https://github.com/u-blox/u-blox-sho-OpenCPU>
- [10] CoreHW, <https://www.corehw.com>



For product change notifications and regular updates of u-blox documentation, register on our website, www.u-blox.com.

Revision history

Revision	Date	Name	Comments
R01	05-Dec-2019	fbro	Initial release.
R02	21-Aug-2020	ovik	Included editorial changes in all sections and replaced EVB-NINA-B3 with EVB-NINA-B4 in all figures. Revised Figure 3 and Figure 18 to show SPI and related pins for U10.
R03	15-Sep-2020	Iber	Confirmed that the EVK-NINA-B3 schematic can be used as a reference during first prototype build, and removed schematic pages 2 and 6 from Appendix A.
R04	1-Jul-2021	mapc	Increased document scope to include EVK-NINA-B410DF variant with u-connectLocate software.

Contact

For complete contact information, visit us at www.u-blox.com.

u-blox Offices

North, Central and South America

u-blox America, Inc.

Phone: +1 703 483 3180
E-mail: info_us@u-blox.com

Regional Office West Coast:

Phone: +1 408 573 3640
E-mail: info_us@u-blox.com

Technical Support:

Phone: +1 703 483 3185
E-mail: support@u-blox.com

Headquarters

Europe, Middle East, Africa

u-blox AG

Phone: +41 44 722 74 44
E-mail: info@u-blox.com
Support: support@u-blox.com

Asia, Australia, Pacific

u-blox Singapore Pte. Ltd.

Phone: +65 6734 3811
E-mail: info_ap@u-blox.com
Support: support_ap@u-blox.com

Regional Office Australia:

Phone: +61 3 9566 7255
E-mail: info_anz@u-blox.com
Support: support_ap@u-blox.com

Regional Office China (Beijing):

Phone: +86 10 68 133 545
E-mail: info_cn@u-blox.com
Support: support_cn@u-blox.com

Regional Office China (Chongqing):

Phone: +86 23 6815 1588
E-mail: info_cn@u-blox.com
Support: support_cn@u-blox.com

Regional Office China (Shanghai):

Phone: +86 21 6090 4832
E-mail: info_cn@u-blox.com
Support: support_cn@u-blox.com

Regional Office China (Shenzhen):

Phone: +86 755 8627 1083
E-mail: info_cn@u-blox.com
Support: support_cn@u-blox.com

Regional Office India:

Phone: +91 80 405 092 00
E-mail: info_in@u-blox.com
Support: support_in@u-blox.com

Regional Office Japan (Osaka):

Phone: +81 6 6941 3660
E-mail: info_jp@u-blox.com
Support: support_jp@u-blox.com

Regional Office Japan (Tokyo):

Phone: +81 3 5775 3850
E-mail: info_jp@u-blox.com
Support: support_jp@u-blox.com

Regional Office Korea:

Phone: +82 2 542 0861
E-mail: info_kr@u-blox.com
Support: support_kr@u-blox.com

Regional Office Taiwan:

Phone: +886 2 2657 1090
E-mail: info_tw@u-blox.com
Support: support_tw@u-blox.com