

# SMD Power Inductor CDRH6D38/T125



Halogen Free



## Description

- Ferrite drum core construction.
- Magnetically shielded.
- L × W × H: 7.0 × 7.0 × 4.0 mm Max.
- Product weight: 0.6g (Ref.)
- Moisture Sensitivity Level: 1
- RoHS compliance.
- Halogen Free available.
- Qualification to AEC-Q200.

## Environmental Data

- Operating temperature range: -40°C ~ +125°C (including coil's self temperature rise)
- Storage temperature range: -40°C ~ +125°C
- Solder reflow temperature: 260 °C peak.

## Packaging

- Carrier tape and reel packaging
- 13.0" diameter reel
- 1000 pcs per reel

## Applications

- Automotive and other high temperature, high reliability application.

## Dimension - [mm]

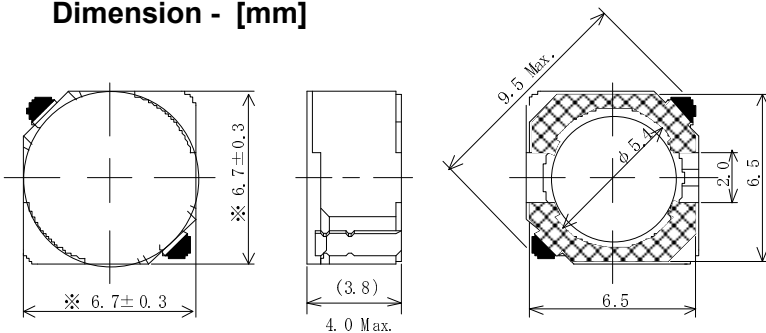

## Land pattern and Schematics - [mm]

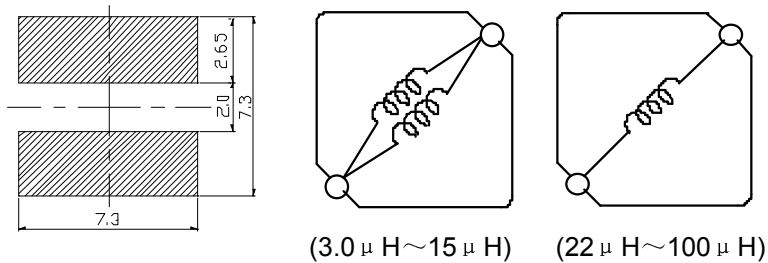

# SMD Power Inductor CDRH6D38/T125



## Electrical Characteristics

Part Name	Stamp	Inductance ( $\mu$ H) 100kHz	D.C.R.(m $\Omega$ ) [Max.] (at 20°C)	Saturation Current (A) ※1		Temperature Rise Current (A) ※2
				(at20°C)	(at125°C) (Typ.)	
CDRH6D38T125NP-3R0NC	3R0	3.0 $\pm$ 30%	22.0(17.5)	3.90	3.00	4.50
CDRH6D38T125NP-3R9NC	3R9	3.9 $\pm$ 30%	24.5(19.6)	3.30	2.50	4.00
CDRH6D38T125NP-4R7NC	4R7	4.7 $\pm$ 30%	27.5(22.0)	3.10	2.40	3.80
CDRH6D38T125NP-5R6NC	5R6	5.6 $\pm$ 30%	30.5(24.4)	2.85	2.10	3.50
CDRH6D38T125NP-6R8NC	6R8	6.8 $\pm$ 30%	33.0(26.4)	2.65	2.00	3.30
CDRH6D38T125NP-100PC	100	10 $\pm$ 25%	43.5(34.8)	2.20	1.70	3.00
CDRH6D38T125NP-150PC	150	15 $\pm$ 25%	59.8(47.8)	1.80	1.50	2.20
CDRH6D38T125NP-220PC	220	22 $\pm$ 25%	103.4(82.7)	1.50	1.00	1.65
CDRH6D38T125NP-330PC	330	33 $\pm$ 25%	145(116)	1.25	0.95	1.45
CDRH6D38T125NP-470PC	470	47 $\pm$ 25%	181(145)	1.00	0.80	1.20
CDRH6D38T125NP-680PC	680	68 $\pm$ 25%	250(200)	0.85	0.65	1.00
CDRH6D38T125NP-101PC	101	100 $\pm$ 25%	372(298)	0.68	0.55	0.85

※1. Saturation current: The value of D.C. current when the inductance decreases to 65% of its nominal value.

※2. Temperature rise current: The value of D.C. current when the temperature rise is  $\Delta t=40^{\circ}\text{C}$  ( $T_a=20^{\circ}\text{C}$ ).

# SMD Power Inductor CDRH6D38/T125



## Saturation Current & Temperature Rise Graph

— L (20°C) — L (125°C) —  $\Delta T$

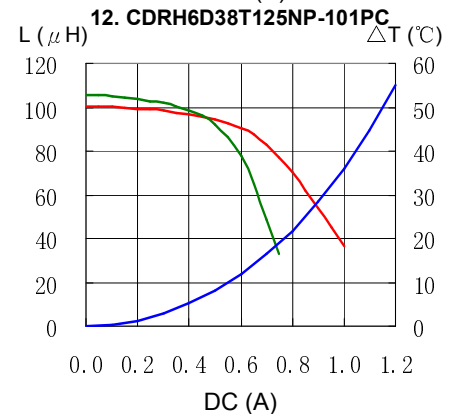
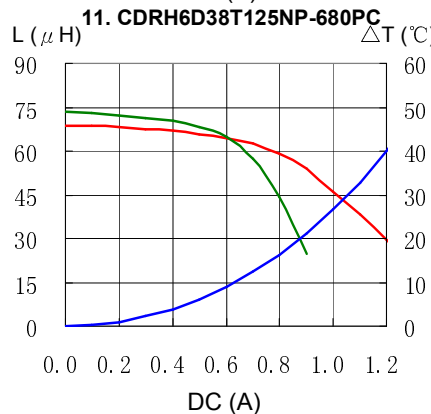
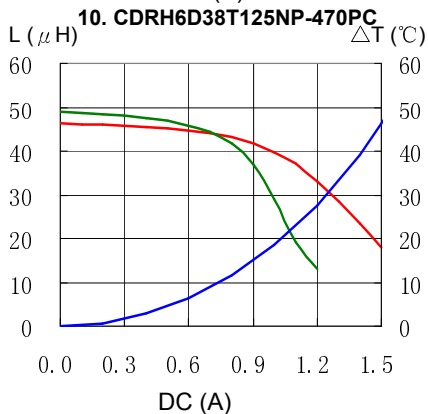
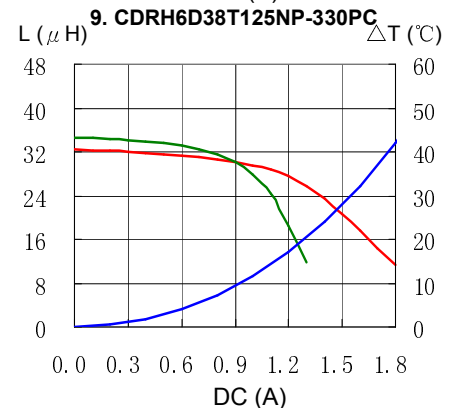
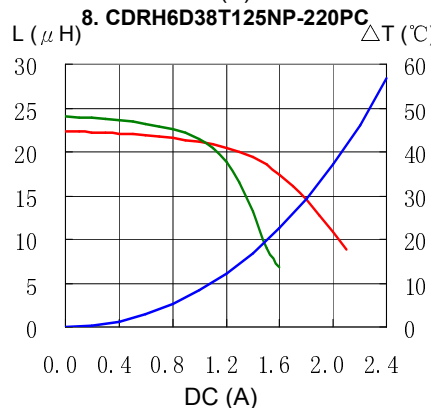
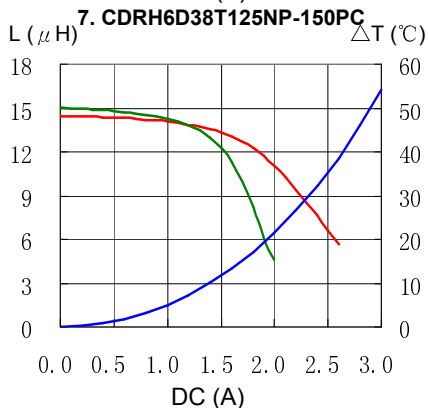
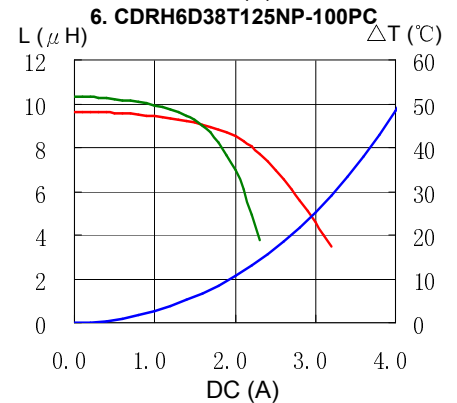
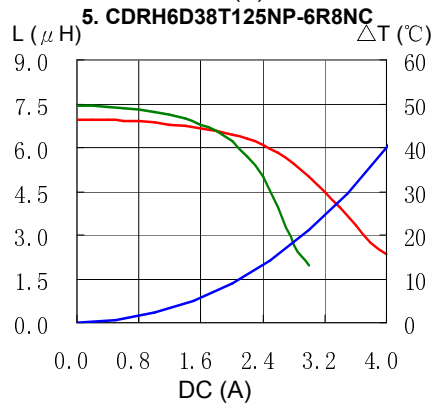
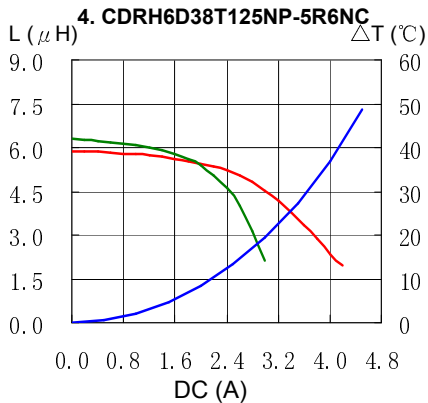
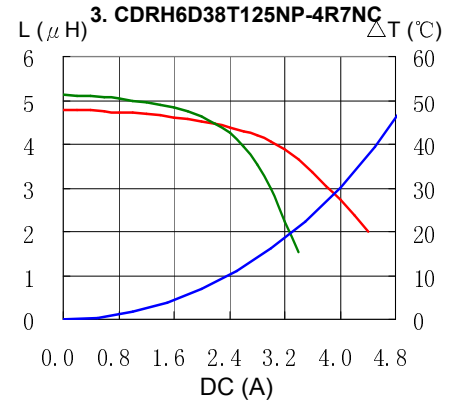
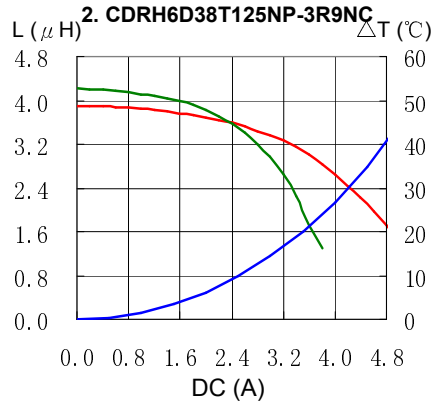
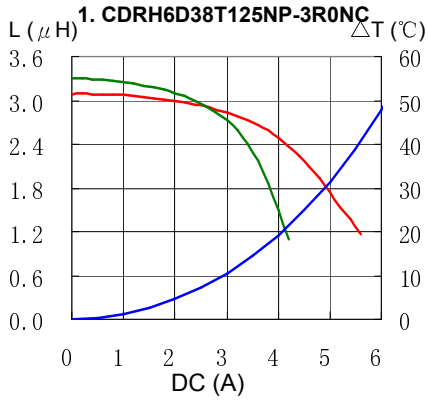

# SMD Power Inductor CDRH6D38/T125



## Solder Reflow Condition

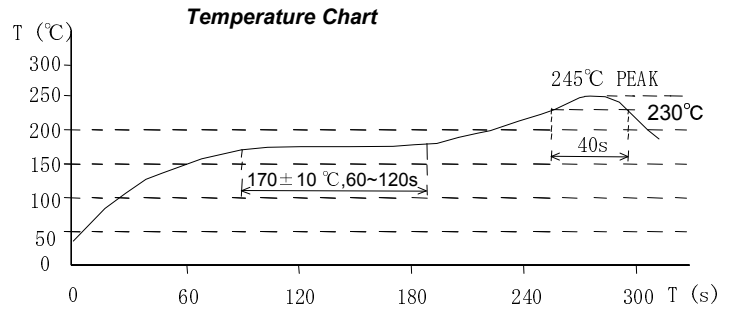
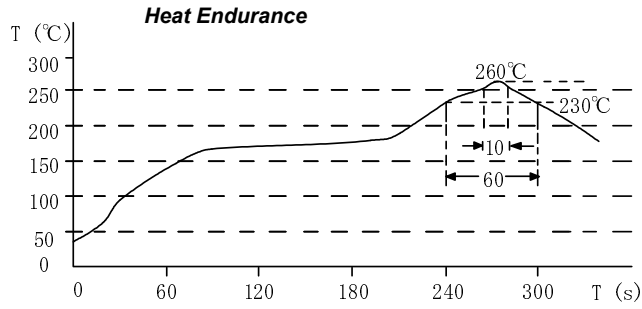

Please refer to the sales offices on our website - <http://www.sumida.com>

**Hong Kong**  
Tel.+852-2880-6781  
FAX.+852-2565-9600  
[sales@hk.sumida.com](mailto:sales@hk.sumida.com)

**Saitama(Japan)**  
Tel.+81-48-691-7300  
FAX.+81-48-691-7340  
[sales@jp.sumida.com](mailto:sales@jp.sumida.com)

**Chicago**  
Tel.+1-847-545-6700  
FAX. +1-847-545-6720  
[sales@us.sumida.com](mailto:sales@us.sumida.com)

**Shanghai**  
Tel.+86-21-5836-3299  
FAX.+86-21-5836-3266  
[shanghai.sales@cn.sumida.com](mailto:shanghai.sales@cn.sumida.com)

**Seoul**  
Tel.+82-2-6237-0777  
FAX.+82-2-6237-0778  
[sales@kr.sumida.com](mailto:sales@kr.sumida.com)

**Oberzell**  
Tel.+49-8591-937-0  
FAX. +49-8591-937-103  
[contact@eu.sumida.com](mailto:contact@eu.sumida.com)

**Shenzhen**  
Tel.+86-755-8291-0228  
FAX.+86-755-8291-0338  
[shenzhen.sales@cn.sumida.com](mailto:shenzhen.sales@cn.sumida.com)

**Singapore**  
Tel.+65-6296-3388  
FAX.+65-6841-4426  
[sales@sg.sumida.com](mailto:sales@sg.sumida.com)

**Neumarkt**  
Tel.+49-9181-4509-110  
FAX. +49-9181-4509-310  
[infocomp@eu.sumida.com](mailto:infocomp@eu.sumida.com)

**Taipei**  
Tel.+886-2-8751-2737  
FAX.+886-2-8751-2738  
[sales@tw.sumida.com](mailto:sales@tw.sumida.com)

**San Jose**  
Tel.+1-408-321-9660  
FAX.+1-408-321-9308  
[sales@us.sumida.com](mailto:sales@us.sumida.com)