

PLL2269SAEL190 - Elliptical Beam

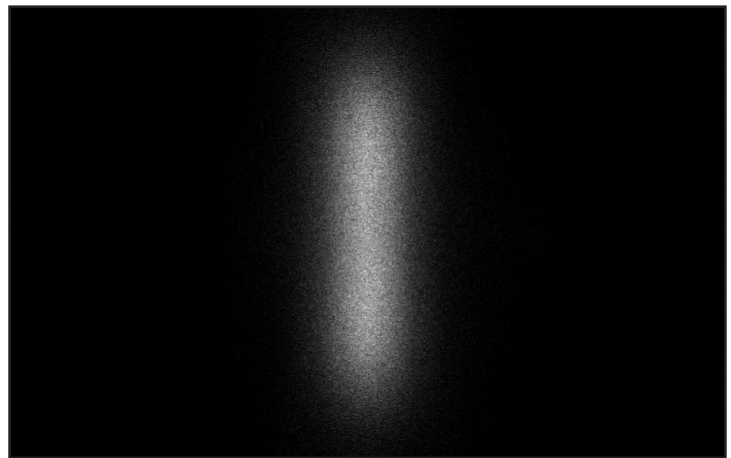

- Material = PMMA
- Full angle at 50% from maximum: $\sim 45^\circ \times 10^\circ$
- Full angle at 10% from maximum: $\sim 60^\circ \times 20^\circ$
- The light spots here represented refer to tests carried out with 1 LED 3.5x3.5mm, and ~ 380 Lumen

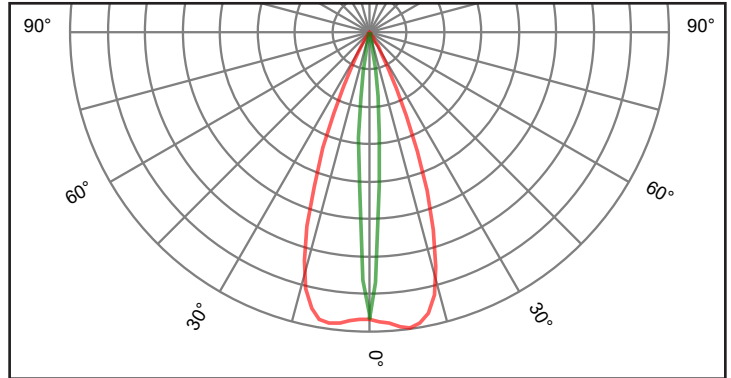
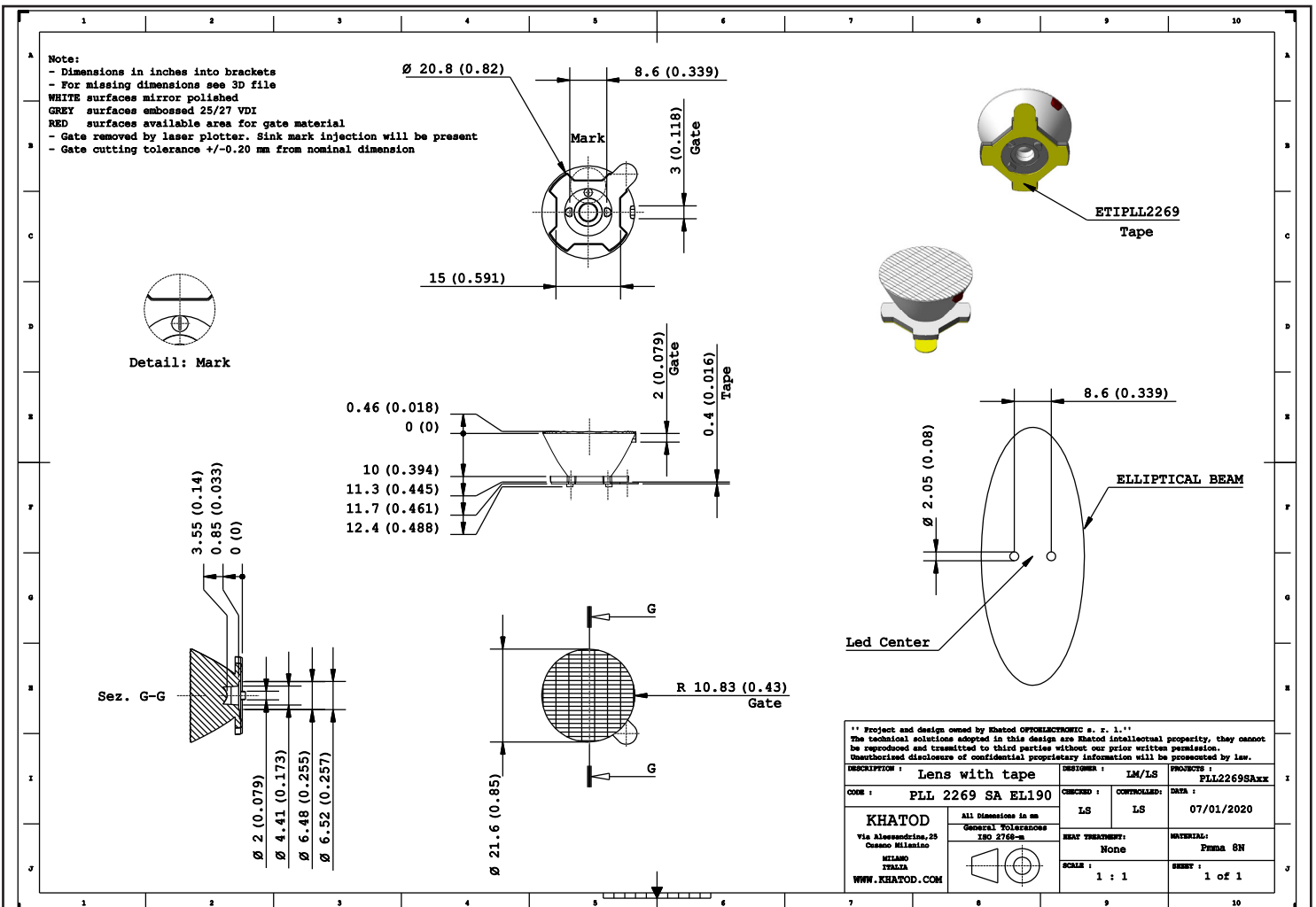

Fixing Adhesive Tape Technical Drawing

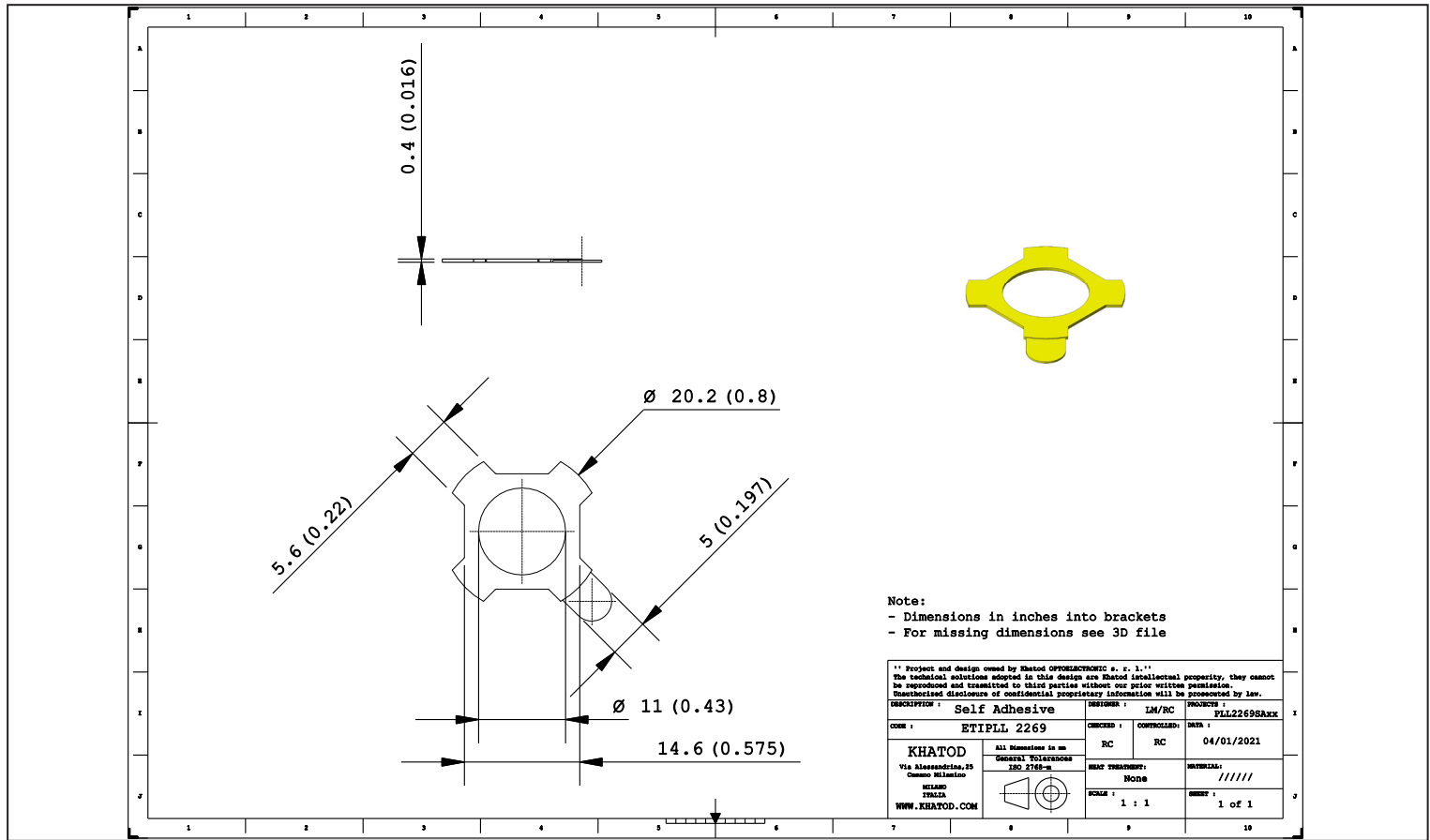

3M High Strength Double Coated Tape with Adhesive 300LSE

9474LE • 9495LE

Technical Data November, 2008

Product Description 3M™ Double Coated Tapes with 3M™ Adhesive 300LSE provides high bond strength to most surfaces, including many low surface energy plastics such as polypropylene and powder coated paints. The acrylic adhesive also provides excellent adhesion to surfaces contaminated lightly with oil typically used with machine parts.

Construction	Product Number	Total Tape Thickness (w/o liner)	Faceside ¹ Adhesive Type/ Thickness	Carrier Type/ Thickness	Backside ² Adhesive Type/ Thickness	Liner Color, Type, Print	Liner Caliper ³
	3M™ Double Coated Tape 9474LE	0.0067" (0.17mm)	0.0028" (0.071mm)	Clear Polyester 0.0005" (0.013mm)	0.0034" (0.086mm)	Faceside Liner/ Tan, 58# Polycoated Kraft, no print Backside liner/ Tan, 58# Polycoated Kraft, *3M 300LSE*	0.0042" (0.11mm) 0.0042" (0.11mm)
	3M™ Double Coated Tape 9495LE	0.0067" (0.17mm)	0.0028" (0.071mm)	Clear Polyester 0.0005" (0.013mm)	0.0034" (0.086mm)	Tan, 58# Polycoated Kraft, *3M 300LSE*	0.0042" (0.11mm)

Note 1: Faceside (FS) adhesive is on the interior of the roll, exposed when unrolled.
Note 2: Backside (BS) adhesive is on the exterior of the roll, exposed when liner is removed.
Note 3: The caliper listed is based on a calculation from manufacturing controlled adhesive coat weights using a density of 1.012 g/cc.

3M™ High Strength Double Coated Tape with Adhesive 300LSE

9474LE • 9495LE

Typical Physical Properties and Performance Characteristics

Note: The following technical information and data should be considered representative or typical only and should not be used for specification purposes.

Product Number	3M™ Double Coated Tapes 9474LE, 9495LE
Adhesion to stainless steel ASTM D3330 - 180 degree 2 mil polyester as backing	Oz/in (N/100 mm) Faceside / Backside 100 (113) / 105 (119)
- 72 hour RT	
Adhesion to stainless steel ASTM D3330 - 90 degree 2 mil al foil	Oz/in (N/100 mm) Faceside/Backside 70 (79) / 80 (90)
- 15 minute RT	
- 72 hour RT	85 (96) / 100 (113)
- 72 hour 158°F (70°C)	106 (119) / 130 (147)
Adhesion to other surfaces ASTM D3330 - 90 degree, 2 mil al foil, 72 hour RT	Oz/in (N/100 mm) Faceside / Backside
ABS	100 (124) / 90 (102)
Polypropylene	90 (102) / 80 (90)
Polycarbonate	150 (169) / 140 (158)
Glass	90 (102) / 100 (113)
Shear Strength - ASTM D3654 Modified - (.5 inch ² sample size)	
1000 grams at 72°F (22°C)	>10,000 minutes
500 grams at 158°F (70°C)	>10,000 minutes
Relative High Temperature Operating Ranges:	
Long Term (days, weeks)	200°F (93°C)
Short Term (minutes, hours)	300°F (149°C)
Relative Solvent Resistance:	Very Good

Assembly Specifications

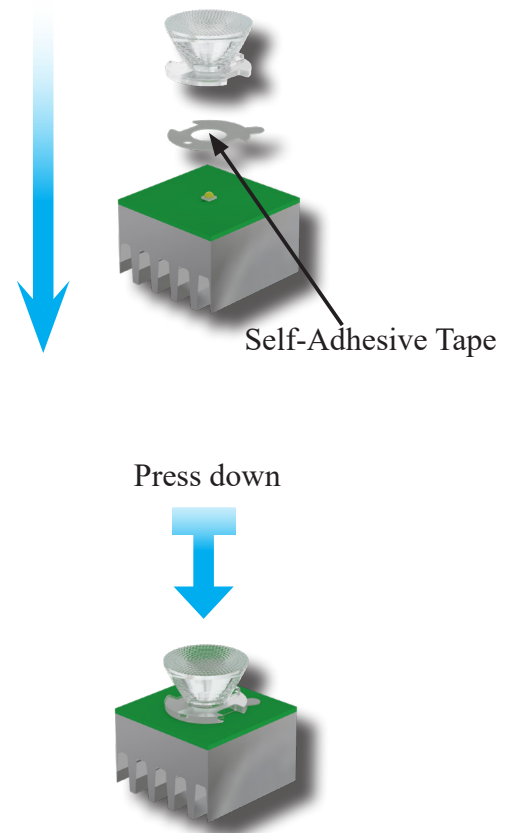
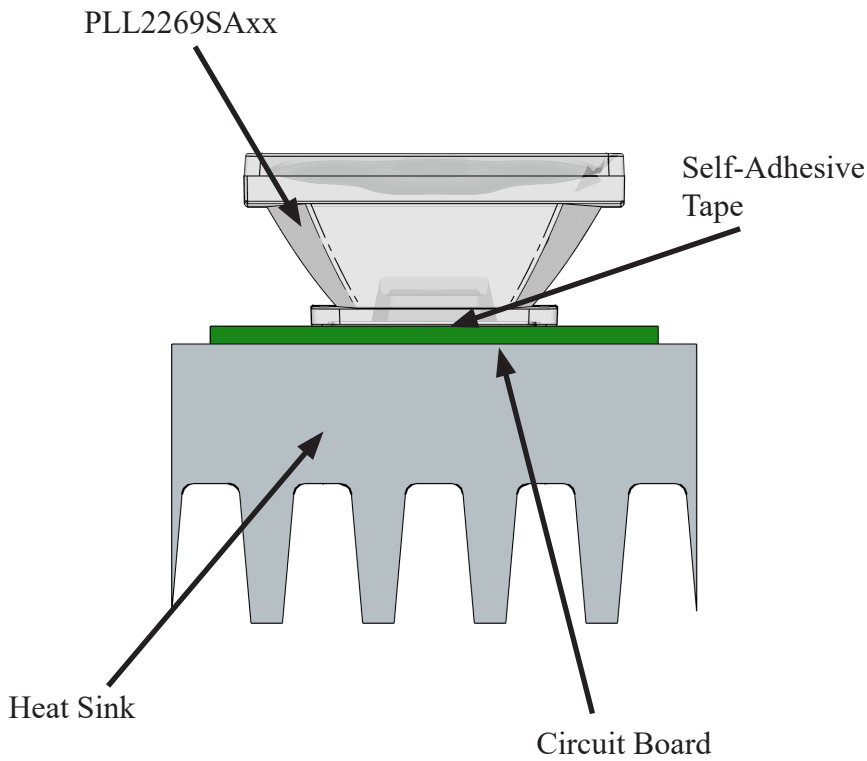

PCB made by Khatod

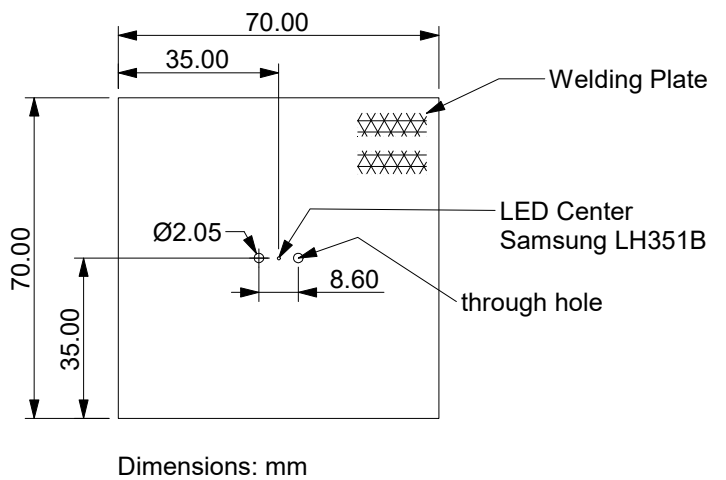

KFP52

LED : Samsung LH351B

Thermal shock resistance level

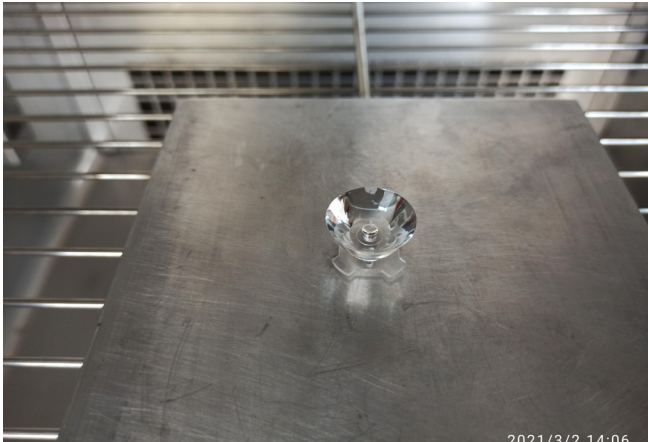

Initial Visual Inspection

Before starting the tests, a visual inspection was performed in order to check the integrity of the part under test.

The part resulted physically intact.

The reference temperature of the component under test is 90° C.

Photo: the part in the climatic chamber.



Temperature set in the climatic chamber

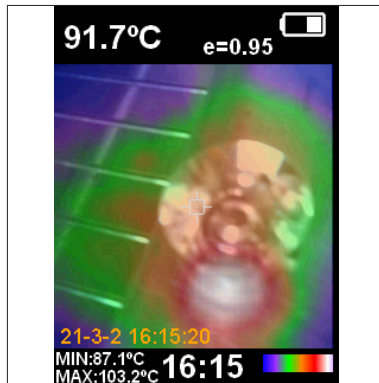

Temperature detected on the part by IR thermal camera



Final Visual Inspection

After testing, a final visual inspection was performed. The result was positive. (view photo)

Photo: the part in the climatic chamber after testing.

Based on the testing result, PLL2269xx test specimens proved to overcome the thermal stress test up to 90°C, without any physical deterioration of the material.

Packaging

Item	Quantity	Total Lens	Size (L*W*H)	G.W.
Trays	76 pcs per Tray	76 pcs	50*32 cm	0.8 Kg
Outer Box	15 Trays per Outer Box	1140 pcs	50*32*38 cm	13.8 Kg

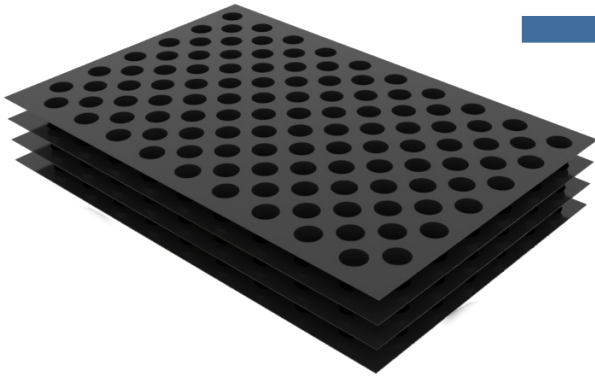

1140 Lenses / 15 Trays

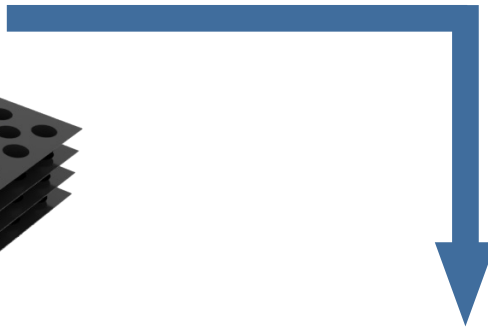

15 Trays / Outer Box

Materials

Material	Top
PMMA	-40°...90°C
PLL2269xx Temperature resistance: long-term exposure	-40°...85°C
PLL2269xx Temperature resistance: short-term exposure	up to + 90 °C

Notes:

- The optical values shown are the result of optical simulations carried out with LIGHTTOOLS, ASAP and ZEMAX software systems. The optical simulations are carried out on the basis of the typical values provided in the LED manufacturers' official datasheets. The photometric analysis has been carried out on physical samples.

Use and Maintenance

- DO NOT HANDLE OR INSTALL LENSES WITHOUT WEARING GLOVES, SKIN OILS MAY DAMAGE LENS OR LIGHT TRANSMISSION;
- CLEAN LENSES WITH MILD SOAP AND WATER AND A SOFT CLOTH;
- DO NOT USE ANY COMMERCIAL CLEANING SOLVENTS ON LENSES.

Disclaimer

Please note that flow lines and weld lines on the external surfaces of the lenses are acceptable if the optical performance of the lens is within the specifications.

Should you require further information, please contact Khatod for advice. All lens testing must be subject to identical conditions as Khatod test condition. Khatod Optoelectronic, Milan, Italy, manufactures lenses for LEDs. Any other use of the lens shall void our liability and warranty. The lenses are an inert component to be used in the manufacture of various products. Our warranty and liability are limited only to the manufacture of the lens. You may not modify, copy, distribute reproduce, license or alter the lens and related materials of Khatod. Khatod does not warrant against damages or defects arising out of the use or misuse of the products; against defects or damage arising from improper installation, or against defects in the product or in its components. No warranty of any kind, expressed or implied, is made regarding the safety of the products. The entire risk as to the quality or performance of the product is with the buyer. In no event shall Khatod be liable for any direct, indirect, punitive, incidental, special, consequential damages, or any damages whatsoever arising out of or connected with the use or misuse of the product. Khatod shall not have any obligation with respect to the product or any part thereof, whether based on contract, tort, strict liability or otherwise. Buyer assumes all risks and liability from use of the product. The laws of Milan, Italy govern this product warranty and liability and you hereby consent to the exclusive jurisdiction and venue of courts in Milan, Italy in all disputes arising out of or relating to the use of this product. Production, marketing, distribution, sale of these products as well as their possible modifications and variations are only exclusive right of Khatod Optoelectronic. No company can perform any of these actions without written permission released by Khatod Optoelectronic. The information contained in this document is proprietary of Khatod Optoelectronic and may change without notice.

REPRODUCTION PROHIBITED.