



## 2ACEW\_4 Series

2W - Single Output AC-DC Converter - Universal Input - Isolated & Regulated

### AC-DC Converter 2 Watt

- ⊕ Wide input voltage range: 85-305VAC/120-430VDC
- ⊕ AC and DC dual-use (input from the same terminal)
- ⊕ Efficiency up to 78%
- ⊕ Operating temperature range: -40°C to +70°C
- ⊕ Isolation voltage: 4kVAC
- ⊕ Over current protection
- ⊕ Short circuit protection (SCP)
- ⊕ Meets CISPR32/EN55032 CLASS B
- ⊕ IEC62368, UL62368, EN62368 safety approved

The 2ACEW\_4 series are compact size power converters. It features wide AC input and at the same time accepts DC input voltage, low power consumption, high efficiency, high reliability, reinforced isolation. It offers good EMC performance, and meets the international UL62368 and EN62368 standards, and they are widely used in industrial, power, instrumentation, communication and civil applications. For extremely harsh EMC environment, we recommend using the typical application circuit show of this datasheet.



UL-62368-1 (E347551)

Model	Power [W]	Output voltage [Vo; V]	Output current [Io; mA]	Capacitive Load [μF, max]	Efficiency [%; typ]
2ACEW_03S4	2	3.3V	600	4000	65
2ACEW_05S4	2	5V	400	4000	70
2ACEW_09S4	2	9V	222	2200	72
2ACEW_12S4	2	12V	167	2200	76
2ACEW_15S4	2	15V	133	1000	76
2ACEW_24S4	2	24V	83	680	78

#### Input specifications

Input voltage range	85-305VAC, 120-430VDC	
Input frequency	47~63Hz	
Input current	115VAC • 0.11A (typ)	230VAC • 0.031A (typ)
Inrush current	115VAC • 7A (typ)	230VAC • 14A (typ)
Leakage current	0.25mA(max)	
Recommended External Input Fuse	• 1A/300VAC	• slow-blow required
Hot plug	Unavailable	

#### Example:

**2ACEW\_05S4**  
2 = 2Watt; AC = AC-DC; E = series; W = Wide input (2:1); 5Vout;  
S = Single Output; 4 = 4kVAC isolation

#### Output specifications

Voltage set accuracy	• 2ACEW_03S4: ±6% • Others: ±5%
Line regulation (full load)	±2%
Load regulation (10% to 100%)	±5%
Ripple & Noise (peak-peak value)	20MHz Bandwidth: 100mV (typ), 200mV (max)
Temperature coefficient	0.04%/°C
Stand-by power consumption	0.2W
Short circuit protection	Hiccup, continuous, self-recovery
Over current protection	120%Io self-recovery
Hold-up time	Vin=230VAC: 50ms TYP

#### Note:

- If the product is not operated within the required load range, the product performance cannot be guaranteed to comply with all parameters in the datasheet;
- Unless otherwise specified, parameters in this datasheet were measured under the conditions of Ta = 25°C, humidity <75% with nominal input voltage and rated output load;
- All index testing methods in this datasheet are based on our company corporate standards;
- We can provide product customization service, please contact our technicians directly for specific information;
- Products are related to laws and regulations: see „Features“ and „EMC“;
- Our products shall be classified according to ISO14001 and related environmental laws and regulations, and shall be handled by qualified units.

## 2ACEW\_4 Series

2W - Single Output AC-DC Converter - Universal Input - Isolated & Regulated

Common specifications			
Operating temperature range	-40°C ~ +70°C		
Power derating temperature range	+55°C ~ +70°C:	3.3%/°C	
	-40°C ~ -25°C:	3.3%/°C	
	85VAC - 100VAC:	1.33%/VAC	
Storage temperature range	-40°C ~ +105°C		
Humidity (non-condensing)	95% MAX		
Cooling	Free air convection		
I/O-isolation voltage	4000VAC/1Min		
EMC / EMI / CE	CISPR32/EN55032,	CLASS B	
EMC / EMI / RE	CISPR32/EN55032,	CLASS B	
EMC / EMS / ESD	IEC/EN 61000-4-2	Contact ±6KV / Air ±8KV	perf. Criteria B
EMC / EMS / RS	IEC/EN 61000-4-3	10V/m	perf. Criteria A
EMC / EMS / EFT	IEC/EN 61000-4-4	± 2kV (see EMC rec. circuit)	perf. Criteria B
EMC / EMS / Surge	IEC/EN 61000-4-5	line to line ±1KV / line to ground ±2KV (see EMC rec. circuit)	perf. Criteria B
EMC / EMS / CS	IEC/EN 61000-4-6	10Vr.m.s	perf. Criteria A
EMC / EMS / Immunities of voltage dip, drop and short interruption	IEC/EN 61000-4-11	0%-70%	perf. Criteria B
Safety standards	IEC62368/EN62368/UL62368		
Safety certification	EC62368/EN62368/UL62368		
Safety class	CLASS II		
Case material	UL94V-0		
MTBF	>300,000h @25°C		
Dimension	33.70 x 22.20 x 18.00mm 76.00 x 31.50 x 26.80mm (chassis mounting) 76.00 x 31.50 x 31.40mm (DIN rail mounting)		
Weight	20g 40g (chassis mounting) 60g (DIN rail mounting)		

## Typical characteristics

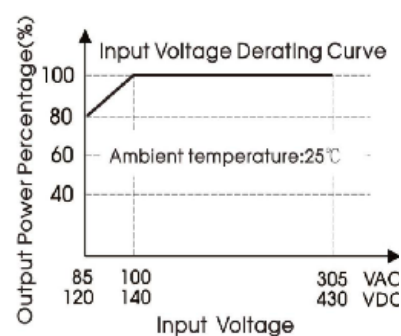
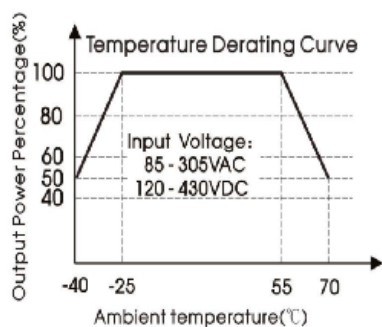

- ① With an AC input between 85-100VAC and a DC input between 120-140VDC, the output power must be derated as per temperature derating curves;
- ② This product is suitable for applications using natural air cooling; for applications in closed environment please consult our team.

## 2ACEW\_4 Series

2W - Single Output AC-DC Converter - Universal Input - Isolated & Regulated

### Efficiency

Efficiency Vs Input Voltage (Full Load)

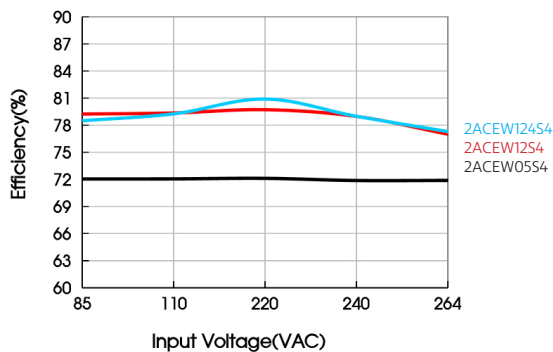

Efficiency Vs Output Load (Vin=230VAC)

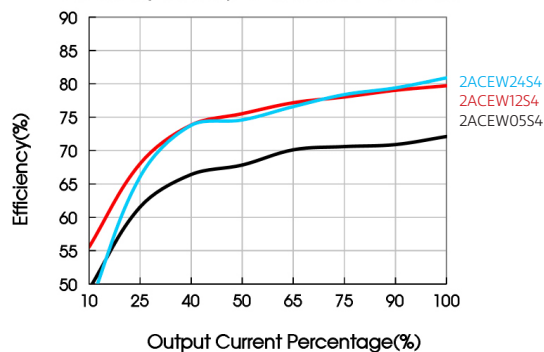

### Typical application circuit

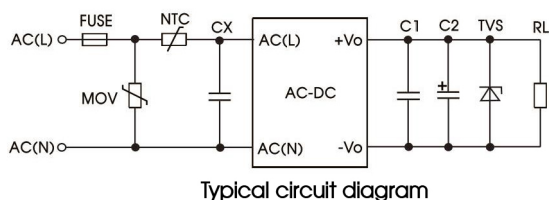

#### Note:

We recommend using an electrolytic capacitor with high frequency, and low ESR rating for C2 (refer to manufacturer's datasheet). Choose a Capacitor voltage rating with at least 20% margin, in other words not exceeding 80%. C1 is a ceramic capacitor used for filtering high-frequency noise and TVS is a recommended suppressor diode to protect the application in case of a converter failure.

External circuit parameters						
Model	FUSE	MOV	NTC	C1 (μF)	C2 (μF)	TVS
2ACEW_03S4	1A/300V, slow-blow required	S14K350	10D-11	1	330	SMBJ7.0A
2ACEW_05S4					220	SMBJ7.0A
2ACEW_09S4					100	SMBJ12A
2ACEW_12S4					100	SMBJ20A
2ACEW_15S4					100	SMBJ20A
2ACEW_24S4					100	SMBJ30A

### EMC compliance recommended circuit

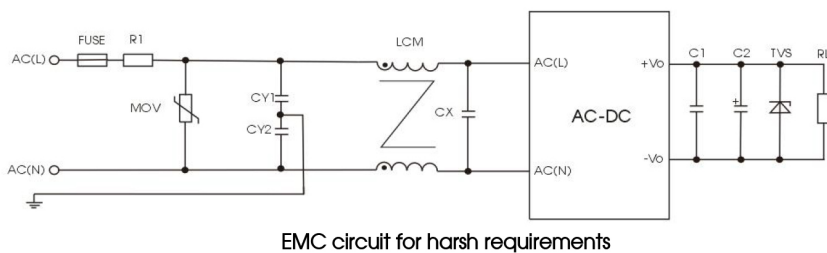

Components	Recommended value
MOV	S14K350
CY1, CY2	2.2nF/400VAC
CX	0.47μF/305VAC
LCM	10mH
R1	47Ω/3W
FUSE	1A/300V, slow-blow required

## 2ACEW\_4 Series

2W - Single Output AC-DC Converter - Universal Input - Isolated & Regulated

### Mechanical dimensions

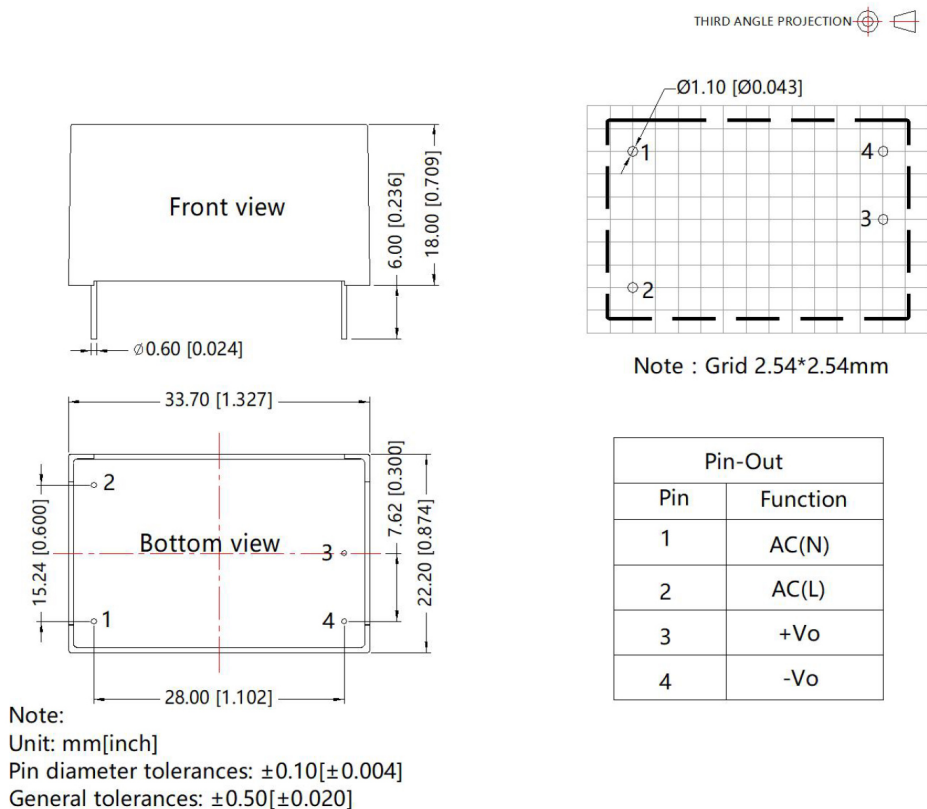

### Chassis mounting

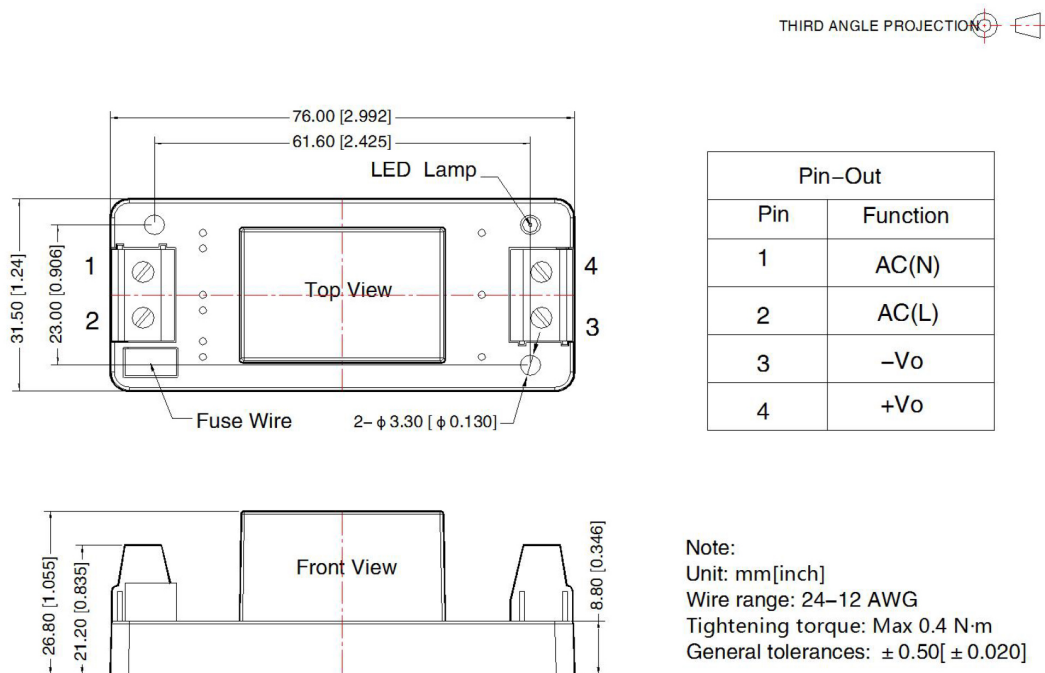

## 2ACEW\_4 Series

2W - Single Output AC-DC Converter - Universal Input - Isolated & Regulated

### DIN rail mounting

THIRD ANGLE PROJECTION 

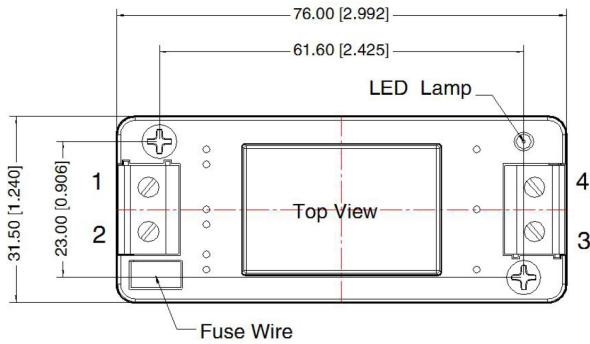

Pin-Out	
Pin	Function
1	AC(N)
2	AC(L)
3	-Vo
4	+Vo

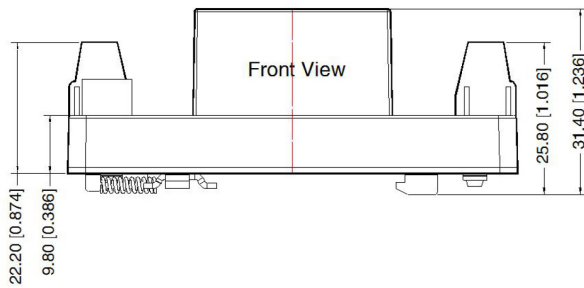

Note:  
 Unit: mm[inch]  
 Wire range: 24-12 AWG  
 Tightening torque: Max 0.4 N·m  
 General tolerances:  $\pm 1.0$  [  $\pm 0.039$  ]