



LED Display Product Data Sheet LTS-3401JF

Spec No.: DS30-2000-163

Effective Date: 08/15/2000

Revision: -

LITE-ON DCC

RELEASE

BNS-OD-FC001/A4

FEATURES

- * 0.8 inch (20.32 mm) DIGIT HEIGHT.
- * CONTINUOUS UNIFORM SEGMENTS.
- * LOW POWER REQUIREMENT.
- * EXCELLENT CHARACTERS APPEARANCE.
- * HIGH BRIGHTNESS & HIGH CONTRAST.
- * WIDE VIEWING ANGLE.
- * SOLID STATE RELIABILITY.
- * CATEGORIZED FOR LUMINOUS INTENSITY.

DESCRIPTION

The LTS-3401JF is a 0.8 inch (20.32 mm) height digit display. The device utilizes AlInGaP yellow orange LED chips which are made from AlInGaP on a non-transparent GaAs substrate, and have light gray face and white segment color.

This low current seven-segment display is designed to perform under low power consumption. It is tested and selected for its excellent low current characteristics. It can be driven in low current condition and the segments are matched. This driving current as low as 1mA per segment is applicable.

DEVICE

PART NO.	DESCRIPTION
AllInGaP YELLOW ORANGE	Common Anode
LTS-3401JF	Rt. & Lt. Hand Decimal

PACKAGE DIMENSIONS

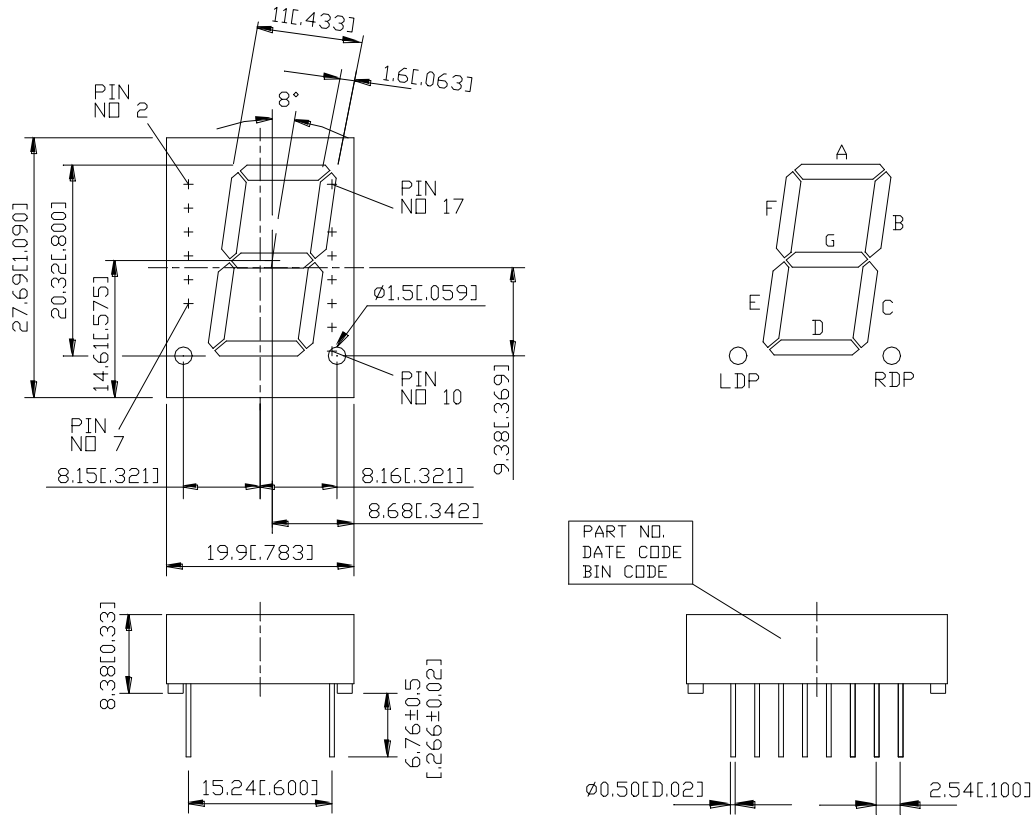

NOTES: All dimensions are in millimeters. Tolerance is ± 0.25 mm (0.01") unless otherwise noted.

INTERNAL CIRCUIT DIAGRAM

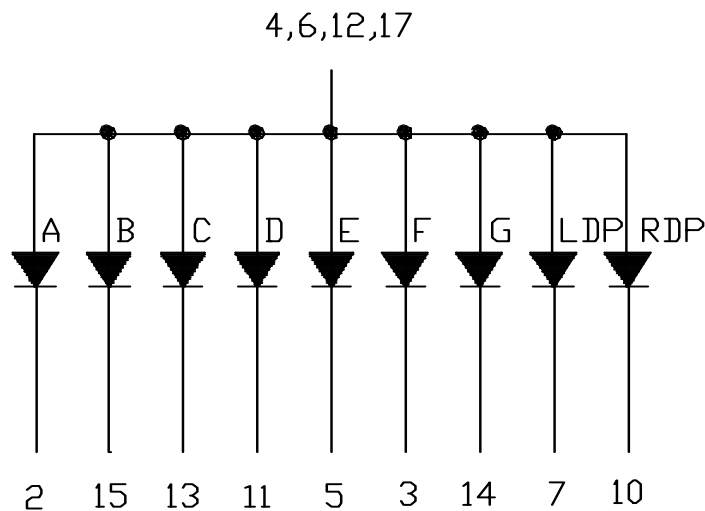

PIN CONNECTION

No.	CONNECTION
1	NO PIN
2	CATHODE A
3	CATHODE F
4	COMMON ANODE
5	CATHODE E
6	COMMON ANODE
7	CATHODE L.D.P
8	NO PIN
9	NO PIN
10	CATHODE R.D.P
11	CATHODE D
12	COMMON ANODE
13	CATHODE C
14	CATHODE G
15	CATHODE B
16	NO PIN
17	COMMON ANODE
18	NO PIN

ABSOLUTE MAXIMUM RATING AT Ta=25°C

PARAMETER	MAXIMUM RATING	UNIT
Power Dissipation Per Segment	70	mW
Peak Forward Current Per Segment (1/10 Duty Cycle, 0.1ms Pulse Width)	90	mA
Continuous Forward Current Per Segment	25	mA
Derating Linear From 25°C Per Segment	0.33	mA/°C
Reverse Voltage Per Segment	5	V
Operating Temperature Range	-35°C to +85°C	
Storage Temperature Range	-35°C to +85°C	
Solder Temperature: max 260°C for max 3sec at 1.6mm[1/16inch] below seating plane.		

ELECTRICAL / OPTICAL CHARACTERISTICS AT Ta=25°C

PARAMETER	SYMBOL	MIN.	TYP.	MAX.	UNIT	TEST CONDITION
Average Luminous Intensity	I _v	320	700		μcd	I _F =1mA
Peak Emission Wavelength	λ _p		611		nm	I _F =20mA
Spectral Line Half-Width	Δλ		17		nm	I _F =20mA
Dominant Wavelength	λ _d		605		nm	I _F =20mA
Forward Voltage Per Segment	V _F		2.05	2.6	V	I _F =20mA
Reverse Current Per Segment	I _R			100	μA	V _R =5V
Luminous Intensity Matching Ratio	I _v -m			2:1		I _F =1mA

Note: Luminous intensity is measured with a light sensor and filter combination that approximates the CIE (Commision Internationale De L'Eclairage) eye-response curve.

TYPICAL ELECTRICAL / OPTICAL CHARACTERISTIC CURVES

(25°C Ambient Temperature Unless Otherwise Noted)

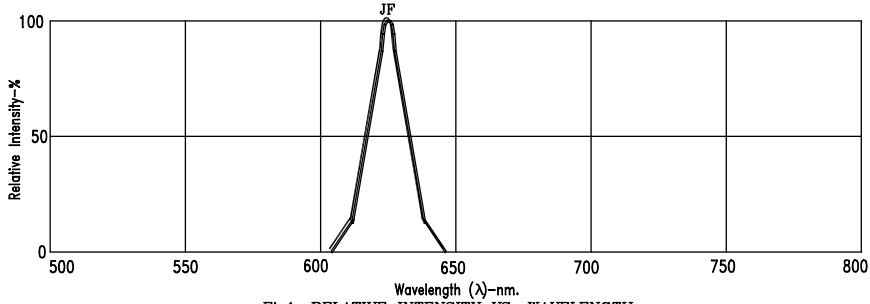

Fig1. RELATIVE INTENSITY VS. WAVELENGTH

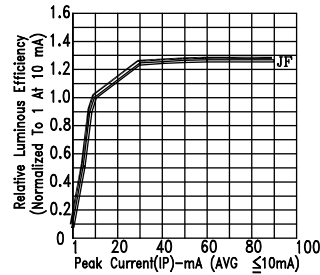

Fig2. RELATIVE LUMINOUS EFFICIENCY (LUMINOUS INTENSITY PER UNIT CURRENT) VS. PEAK CURRENT

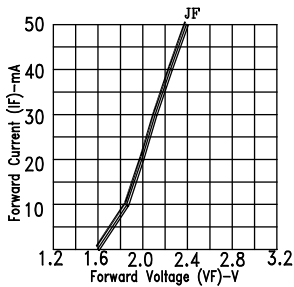

Fig3. FORWARD CURRENT VS. FORWARD VOLTAGE

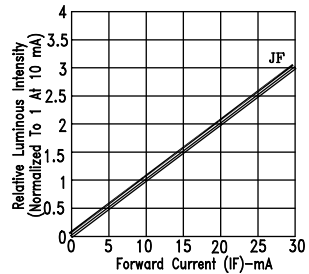

Fig4. RELATIVE LUMINOUS INTENSITY VS. FORWARD CURRENT

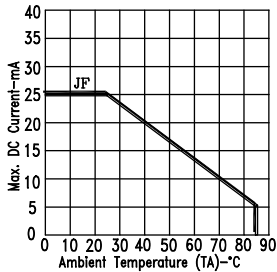

Fig5. MAX. ALLOWABLE DC CURRENT VS. AMBIENT TEMPERATURE.

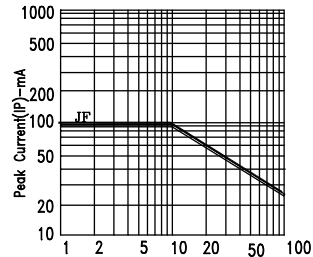

Fig6. MAX. PEAK CURRENT VS. DUTY CYCLE % (REFRESH RATE 1KHz)

NOTE : JF=AlInGaP YELLOW ORANGE (REFRESH RATE 1KHz)