

A09 - ADAPTOR FOR DIN B

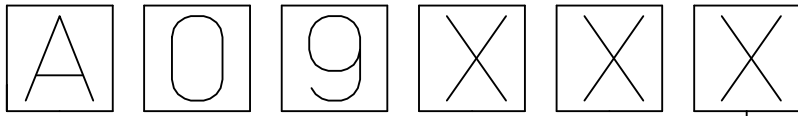

INTERNAL CIRCUIT

VOLTAGE AND LED COLOUR:

1= 12V	A= 12V	G= 12V
2= 24V	B= 24V	H= 24V
3= 48V	C= 48V	K= 48V
4= 115V	D= 115V	L= 115V
5= 230V	E= 230V	M= 230V

RED LED GREEN LED YELLOW LED

Chart 1

Engineering no.	SAP Part Number	Circuit type	LED Color
A09C4H	1210010440	C4 24V	Yellow
A09C4L	1210010441	C4 115V	Yellow
A09C4M	1210010327	C4 230V	Yellow
A09G2H	1210010411	G2 24V	Yellow
A09G2M	1210010434	G2 230V	Yellow
A09S0H	1210010435	S0 24V	Yellow
A09G2L	1210010419	G2 115V	Yellow

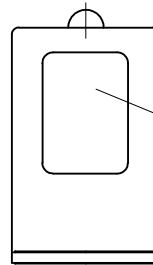

CIRCUIT TAMPOPRINT (WHITE)

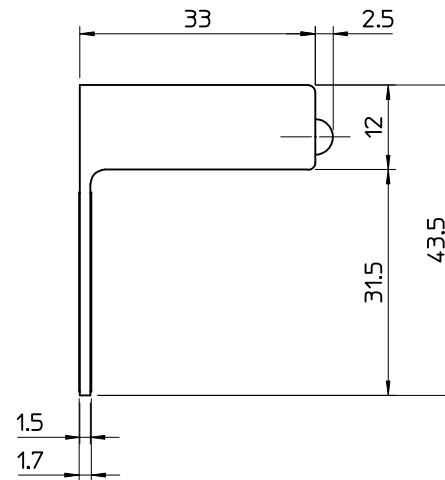
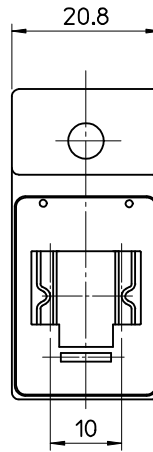

Wiring configuration

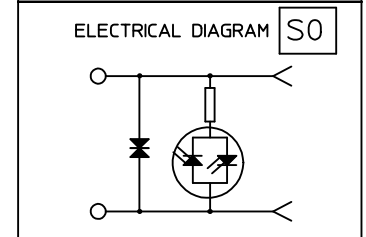
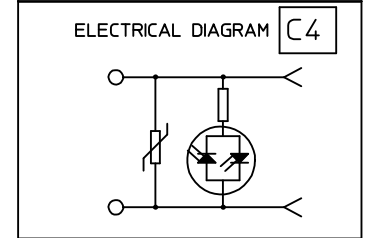
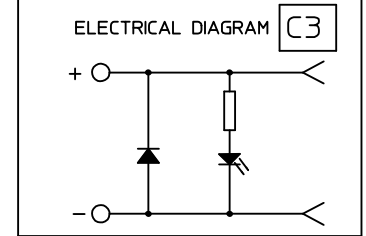
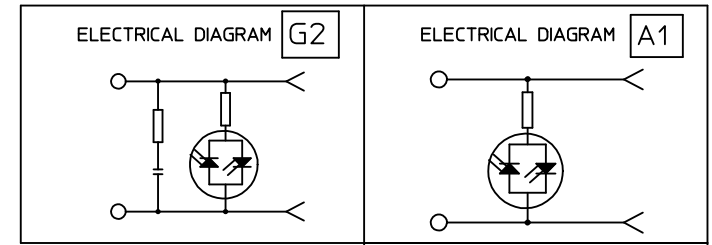

DRAWING UPDATE EC NO: IPG2016-0461 DRWN: JMARSZALEK 2013/06/08 CHKD: MSZWAJKOWSKI 2013/06/10 APPR: MIWASIECZKO 2015/09/28	QUALITY SYMBOLS ▽=0 ▽=0	GENERAL TOLERANCES (UNLESS SPECIFIED)		DIMENSION STYLE MM ONLY		SCALE -	DESIGN UNITS METRIC	FIRST ANGLE PROJECTION LIGHTS ADAPTORS SERIES A09XXX FOR DIN B molex	
				DRAWN BY DATE JMARSZALEK 2013/02/11		TITLE			
				CHECKED BY DATE MSZWAJKOWSKI 2013/02/11		DOCUMENT NO. SD-121001-009			
				APPROVED BY DATE MIWASIECZKO 2013/02/12		SHEET NO. 1 OF 1			
A1	REV	ANGULAR ±---°		MATERIAL NO.					
		DRAFT WHERE APPLICABLE MUST REMAIN WITHIN DIMENSIONS		SEE CHART 1		THIS DRAWING CONTAINS INFORMATION THAT IS PROPRIETARY TO MOLEX INCORPORATED AND SHOULD NOT BE USED WITHOUT WRITTEN PERMISSION			

A09 - ADAPTOR FOR DIN B

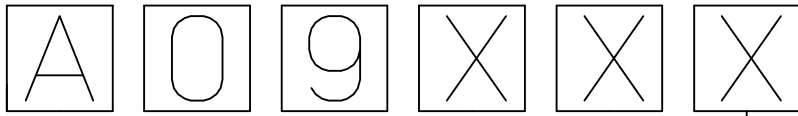

INTERNAL CIRCUIT

VOLTAGE AND LED COLOUR:

1= 12V	A= 12V	G= 12V
2= 24V	B= 24V	H= 24V
3= 48V	C= 48V	K= 48V
4= 115V	D= 115V	L= 115V
5= 230V	E= 230V	M= 230V

RED LED GREEN LED YELLOW LED

Chart 1

Engineering no.	SAP Part Number	Circuit type	LED Color
A09C4H	1210010440	C4 24V	Yellow
A09C4L	1210010441	C4 115V	Yellow
A09C4M	1210010327	C4 230V	Yellow
A09G2H	1210010411	G2 24V	Yellow
A09G2M	1210010434	G2 230V	Yellow
A09S0H	1210010435	S0 24V	Yellow
A09G2L	1210010419	G2 115V	Yellow

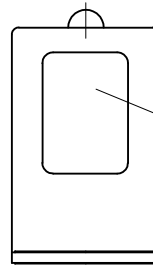

CIRCUIT TAMOPRINT (WHITE)

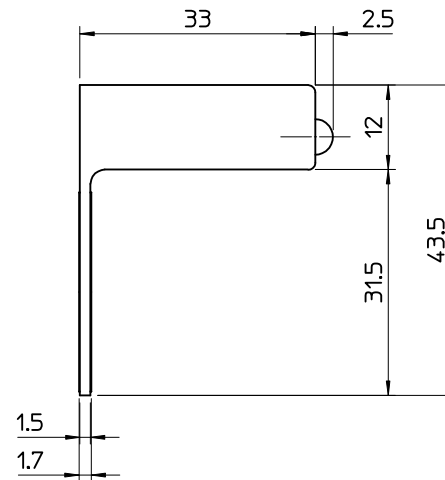
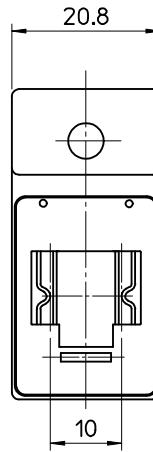

Wiring configuration

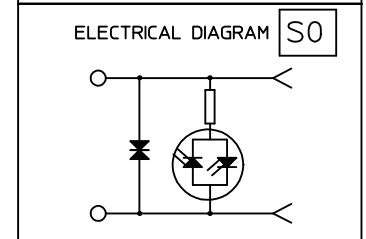
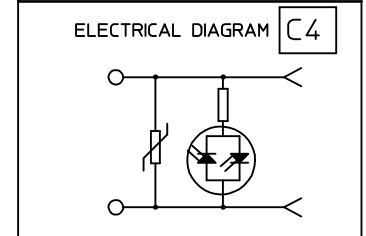
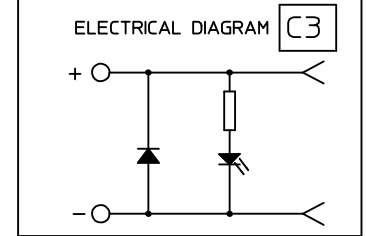
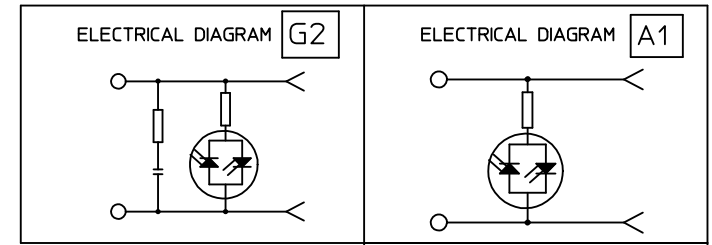

DRAWING UPDATE EC NO: IPG2016-0461 DRWN: JMARSZALEK 2013/06/08 CHKD: MSZWAJKOWSKI 2013/06/10 APPR: MIWASIECZKO 2015/09/28	QUALITY SYMBOLS ▽=0 ▽=0	GENERAL TOLERANCES (UNLESS SPECIFIED)		DIMENSION STYLE MM ONLY		SCALE -	DESIGN UNITS METRIC	FIRST ANGLE PROJECTION LIGHTS ADAPTORS SERIES A09XXX FOR DIN B molex	
				DRAWN BY DATE JMARSZALEK 2013/02/11		TITLE			
				CHECKED BY DATE MSZWAJKOWSKI 2013/02/11		DOCUMENT NO. SD-121001-009			
				APPROVED BY DATE MIWASIECZKO 2013/02/12		SHEET NO. 1 OF 1			
A1	REV	ANGULAR ±---°		MATERIAL NO.		THIS DRAWING CONTAINS INFORMATION THAT IS PROPRIETARY TO MOLEX INCORPORATED AND SHOULD NOT BE USED WITHOUT WRITTEN PERMISSION			
		DRAFT WHERE APPLICABLE MUST REMAIN WITHIN DIMENSIONS		SEE CHART 1					