

N Channel Super Junction Power MOSFET III

General Description

The series of devices use advanced trench gate super junction technology and design to provide excellent $R_{DS(ON)}$ with low gate charge. This super junction MOSFET fits the industry's AC-DC SMPS requirements for PFC, AC/DC power conversion, and industrial power applications.

Features

- New technology for high voltage device
- Low on-resistance and low conduction losses
- Small package
- Ultra Low Gate Charge cause lower driving requirements
- 100% Avalanche Tested
- ROHS compliant

Application

- Power factor correction (PFC)
- Switched mode power supplies(SMPS)
- Uninterruptible Power Supply (UPS)
- Halogen-free

V_{DS}	650	V
$R_{DS(ON) MAX}$	210	m Ω
I_D	20	A

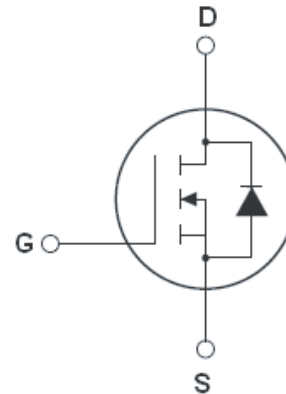

Schematic diagram

Package Marking And Ordering Information

Device	Device Package	Marking
RM20N650HD	TO-263	20N650
RM20N650T2	TO-220	20N650
RM20N650TI	TO-220F	20N650



TO-263

TO-220

TO-220F

Table 1. Absolute Maximum Ratings ($T_c=25^\circ\text{C}$)

Parameter	Symbol	RM20N650HD RM20N650T2	RM20N650TI	Unit
Drain-Source Voltage ($V_{GS}=0V$)	V_{DS}	650		V
Gate-Source Voltage ($V_{DS}=0V$) AC ($f>1$ Hz)	V_{GS}	± 30		V
Continuous Drain Current at $T_c=25^\circ\text{C}$	$I_{D(DC)}$	20		A
Continuous Drain Current at $T_c=100^\circ\text{C}$	$I_{D(DC)}$	13		A
Pulsed drain current (Note 1)	$I_{DM(pluse)}$	80		A
Maximum Power Dissipation($T_c=25^\circ\text{C}$)	P_D	180	33	W
Derate above 25°C		1.5	0.27	W/ $^\circ\text{C}$
Single pulse avalanche energy (Note 2)	E_{AS}	420		mJ
Avalanche current (Note 1)	I_{AR}	10		A
Repetitive Avalanche energy, t_{AR} limited by T_{jmax} (Note 1)	E_{AR}	0.7		mJ

Parameter	Symbol	RM20N650HD RM20N650T2	RM20N650TI	Unit
Drain Source voltage slope, $V_{DS} \leq 480$ V,	dv/dt	50		V/ns
Reverse diode dv/dt, $V_{DS} \leq 480$ V, $I_{SD} < I_D$	dv/dt	15		V/ns
Operating Junction and Storage Temperature Range	T_J, T_{STG}	-55...+150		°C

* limited by maximum junction temperature

Table 2. Thermal Characteristic

Parameter	Symbol	RM20N650HD RM20N650T2	RM20N650TI	Unit
Thermal Resistance, Junction-to-Case (Maximum)	R_{thJC}	0.66	3.69	°C / W
Thermal Resistance, Junction-to-Ambient (Maximum)	R_{thJA}	62	80	°C / W

Table 3. Electrical Characteristics (TA=25°C unless otherwise noted)

Parameter	Symbol	Condition	Min	Typ	Max	Unit
On/off states						
Drain-Source Breakdown Voltage	BV_{DSS}	$V_{GS}=0V, I_D=250\mu A$	650			V
Zero Gate Voltage Drain Current($T_c=25^\circ C$)	I_{DSS}	$V_{DS}=650V, V_{GS}=0V$			1	μA
Zero Gate Voltage Drain Current($T_c=125^\circ C$)	I_{DSS}	$V_{DS}=650V, V_{GS}=0V$			100	μA
Gate-Body Leakage Current	I_{GSS}	$V_{GS}=\pm 20V, V_{DS}=0V$			± 100	nA
Gate Threshold Voltage	$V_{GS(th)}$	$V_{DS}=V_{GS}, I_D=250\mu A$	2	3.5	5	V
Drain-Source On-State Resistance	$R_{DS(on)}$	$V_{GS}=10V, I_D=10A$		165	210	m Ω
Dynamic Characteristics						
Input Capacitance	C_{iss}	$V_{DS}=50V, V_{GS}=0V,$ $F=1.0MHz$		2600		pF
Output Capacitance	C_{oss}			90		pF
Reverse Transfer Capacitance	C_{rss}			8		pF
Total Gate Charge	Q_g	$V_{DS}=480V, I_D=17A,$ $V_{GS}=10V$		48		nC
Gate-Source Charge	Q_{gs}			17		nC
Gate-Drain Charge	Q_{gd}			14		nC
Switching times						
Turn-on Delay Time	$t_{d(on)}$	$V_{DD}=480V, I_D=8.5A,$ $R_G=2.3\Omega, V_{GS}=10V$		14		nS
Turn-on Rise Time	t_r			12		nS
Turn-Off Delay Time	$t_{d(off)}$			65		nS
Turn-Off Fall Time	t_f			6		nS
Source- Drain Diode Characteristics						
Source-drain current(Body Diode)	I_{SD}	$T_c=25^\circ C$			20	A
Pulsed Source-drain current(Body Diode)	I_{SDM}				80	A
Forward On Voltage	V_{SD}	$T_j=25^\circ C, I_{SD}=17A, V_{GS}=0V$		0.9	1.2	V
Reverse Recovery Time	t_{rr}	$T_j=25^\circ C, I_F=8.5A, di/dt=100A/\mu s$		320		nS
Reverse Recovery Charge	Q_{rr}			3.1		μC
Peak Reverse Recovery Current	I_{rrm}			26		A

Notes 1.Repetitive Rating: Pulse width limited by maximum junction temperature

2. $T_j=25^\circ C, V_{DD}=50V, V_G=10V, R_G=25\Omega$

RATING AND CHARACTERISTICS CURVES (RM20N650T2/TI/HD)

Figure1. Safe operating area for TO-220

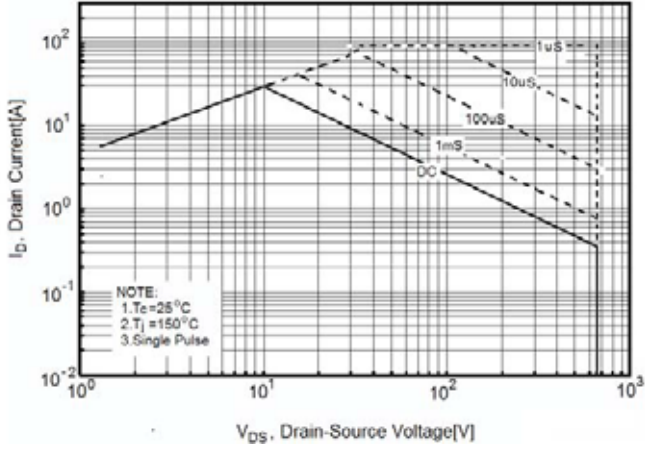

Figure2. Safe operating area for TO-220F

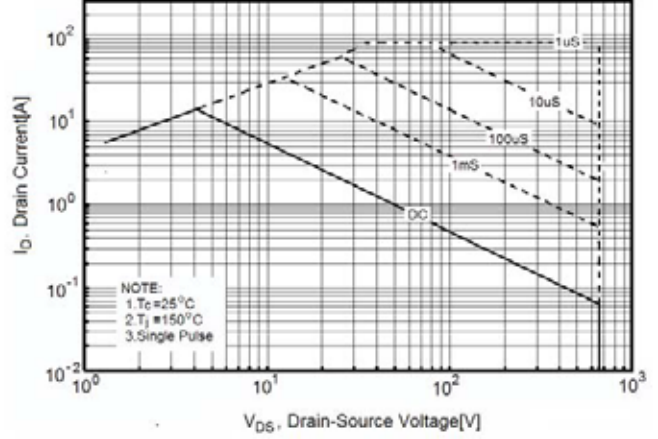

Figure3. Source-Drain Diode Forward Voltage

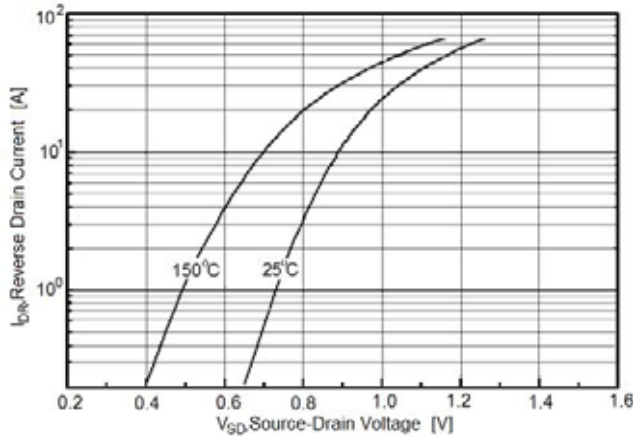

Figure4. Output characteristics

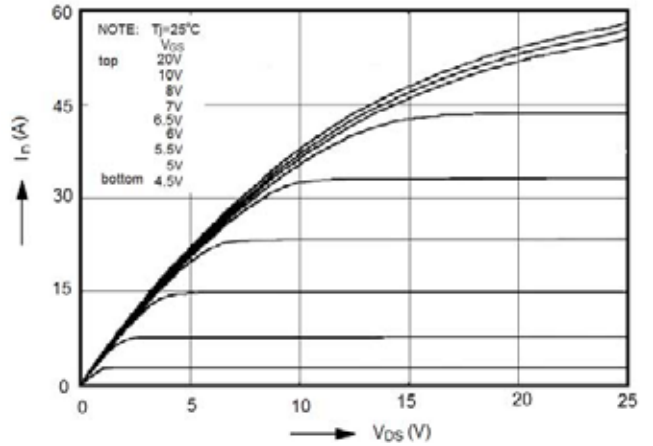

Figure5. Transfer characteristics

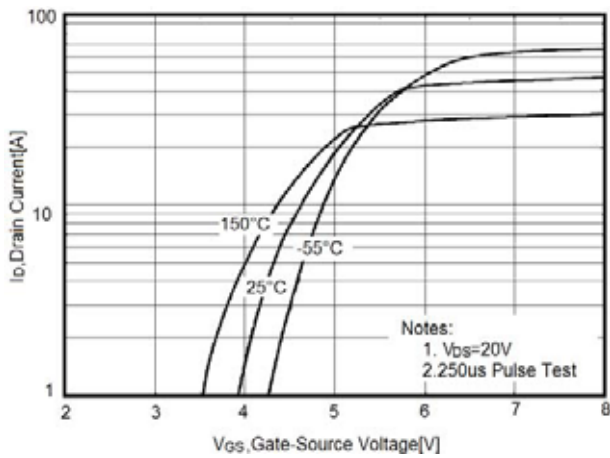
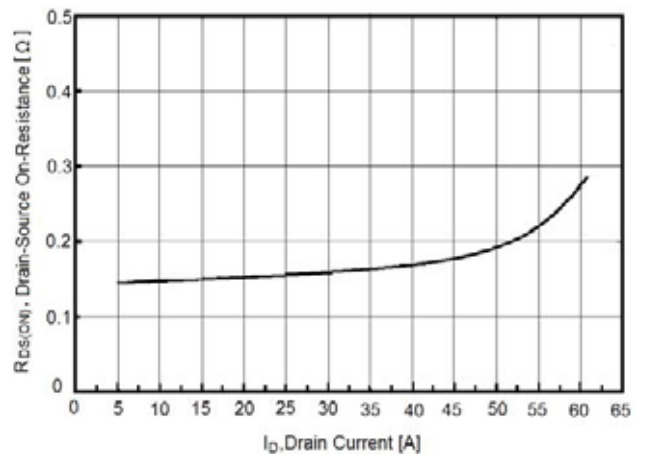

Figure6. Static drain-source on resistance



RATING AND CHARACTERISTICS CURVES (RM20N650T2/TI/HD)

Figure7. $R_{DS(ON)}$ vs Junction Temperature

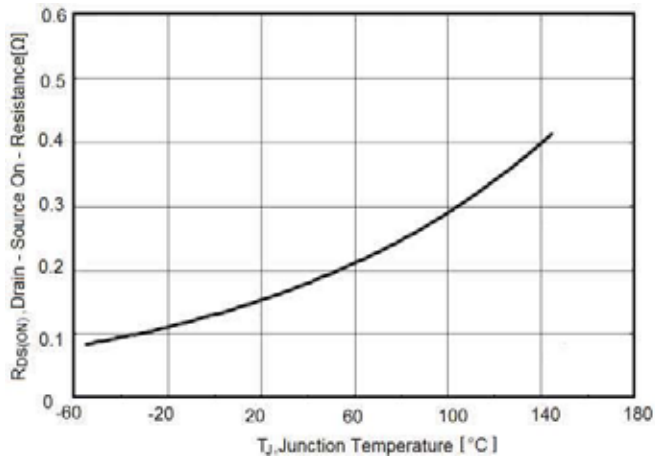

Figure8. BV_{DSS} vs Junction Temperature

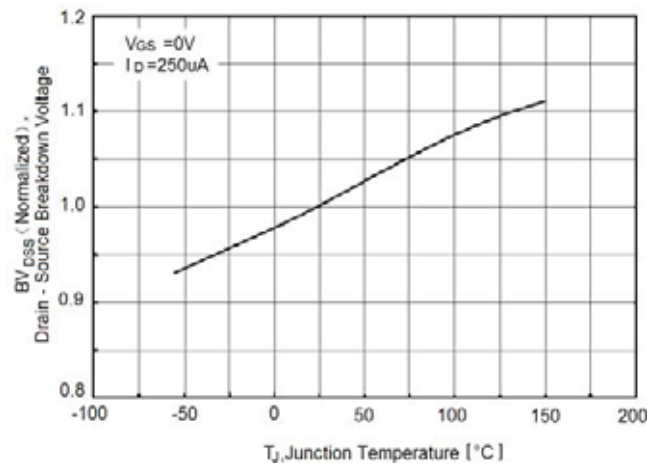

Figure9. Maximum I_D vs Junction Temperature

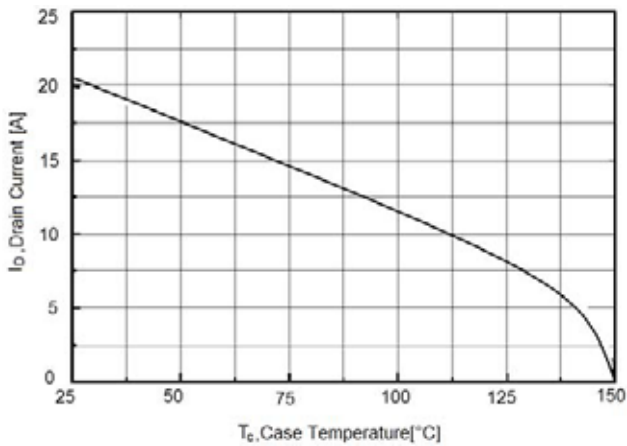

Figure10. Transient Thermal Impedance for TO-220

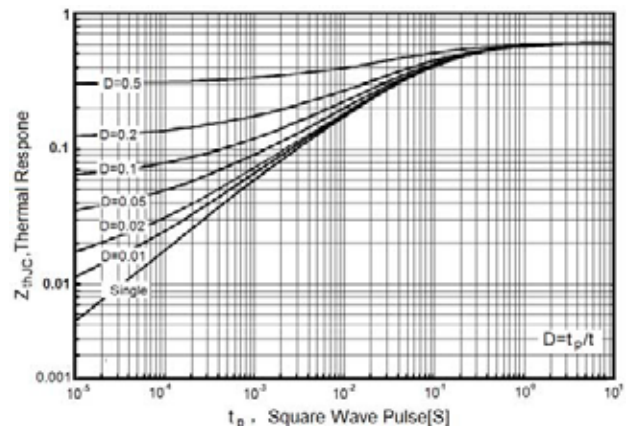
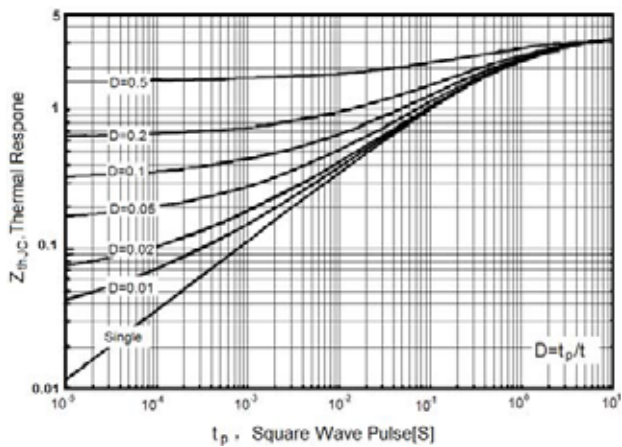
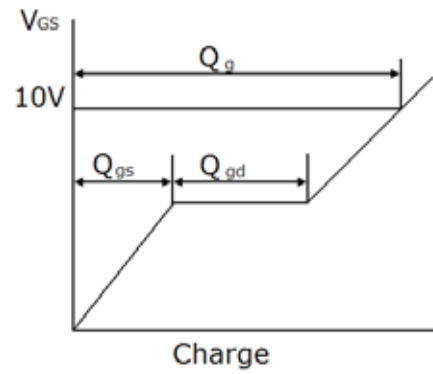
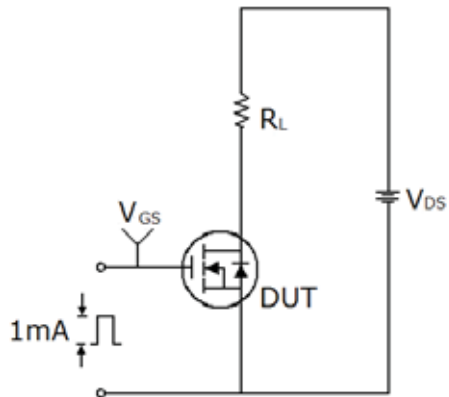

Figure11. Transient Thermal Impedance for TO-220F



Test circuit

1) Gate charge test circuit & Waveform



2) Switch Time Test Circuit:

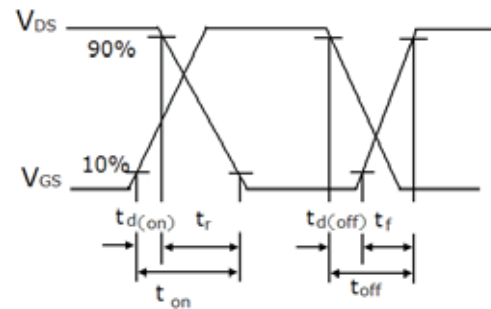
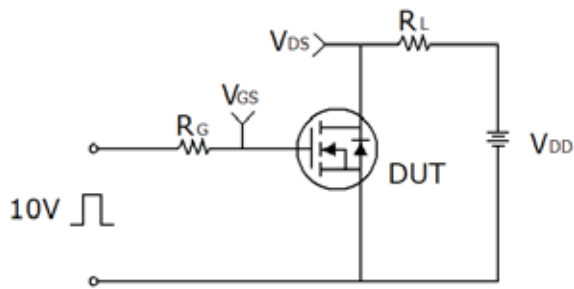

3) Unclamped Inductive Switching Test Circuit & Waveforms

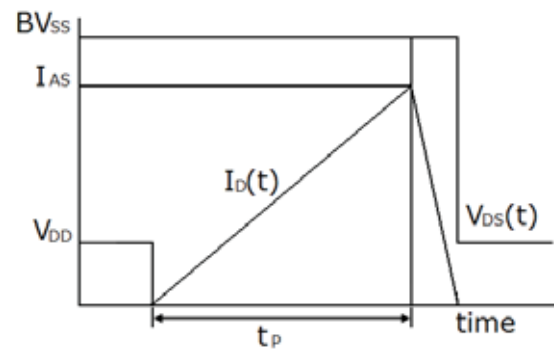
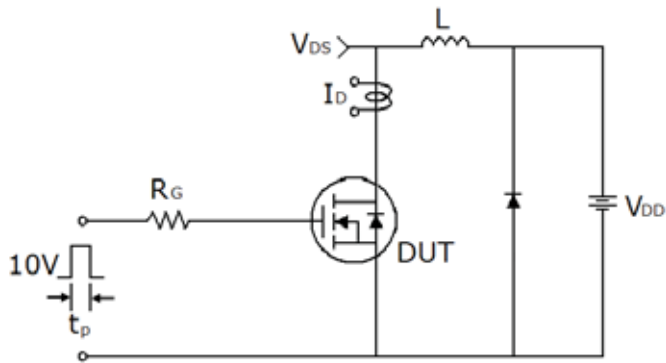



RECTRON

Marking on the body



← Rectron Logo

2 0 N 6 5 0 ← Part No.

1 8 X X

Year – Code
(Y:18-----2018
19-----2019.....)

Week – code
(WW:01~52)

TO-263-3L Package Information

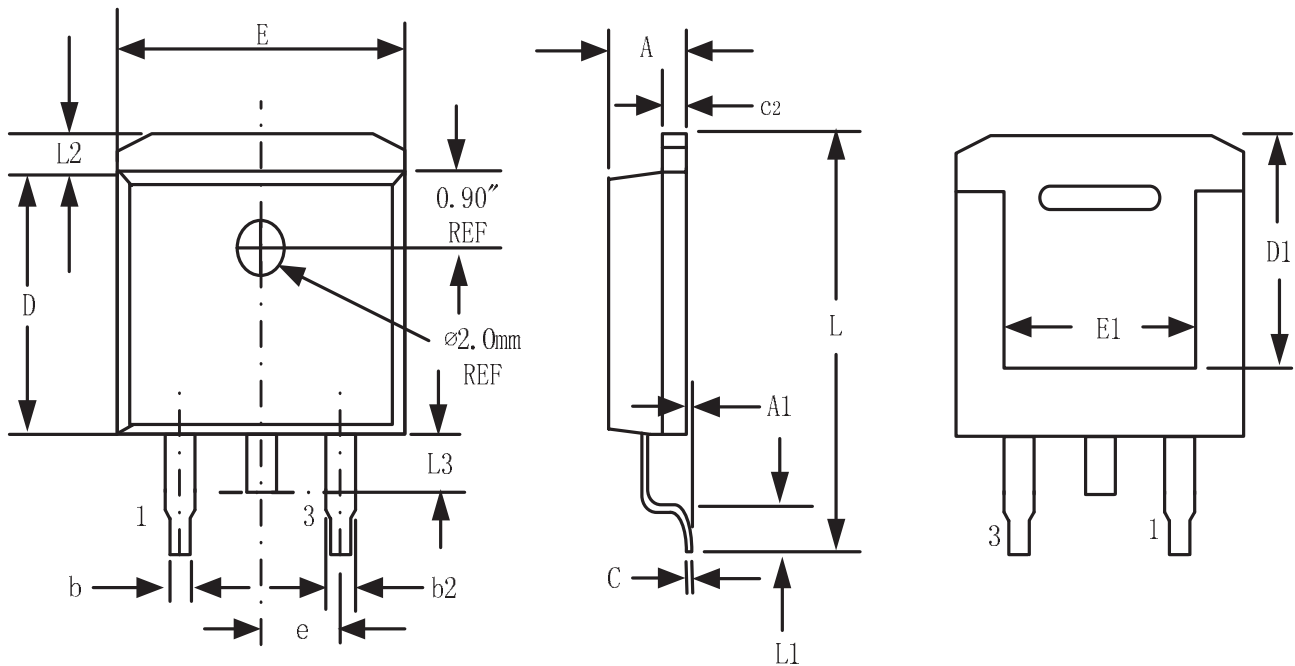

Symbol	Dimensions In Millimeters		Dimensions In Inches	
	Min.	Max.	Min.	Max.
A	4.32	4.57	0.170	0.180
A1	-	0.25		0.010
b	0.71	0.94	0.028	0.037
b2	1.15	1.40	0.045	0.055
c	0.46	0.61	0.018	0.024
c2	1.22	1.40	0.048	0.055
D	8.89	9.40	0.350	0.370
D1	8.01	8.23	0.315	0.324
E	10.04	10.28	0.395	0.405
E1	7.88	8.08	0.310	0.318
e	2.54 BSC		0.100 BSC	
L	14.73	15.75	0.580	0.620
L1	2.29	2.79	0.090	0.110
L2	1.15	1.39	0.045	0.055
L3	1.27	1.77	0.050	0.070

TO-220-3L-C Package Information

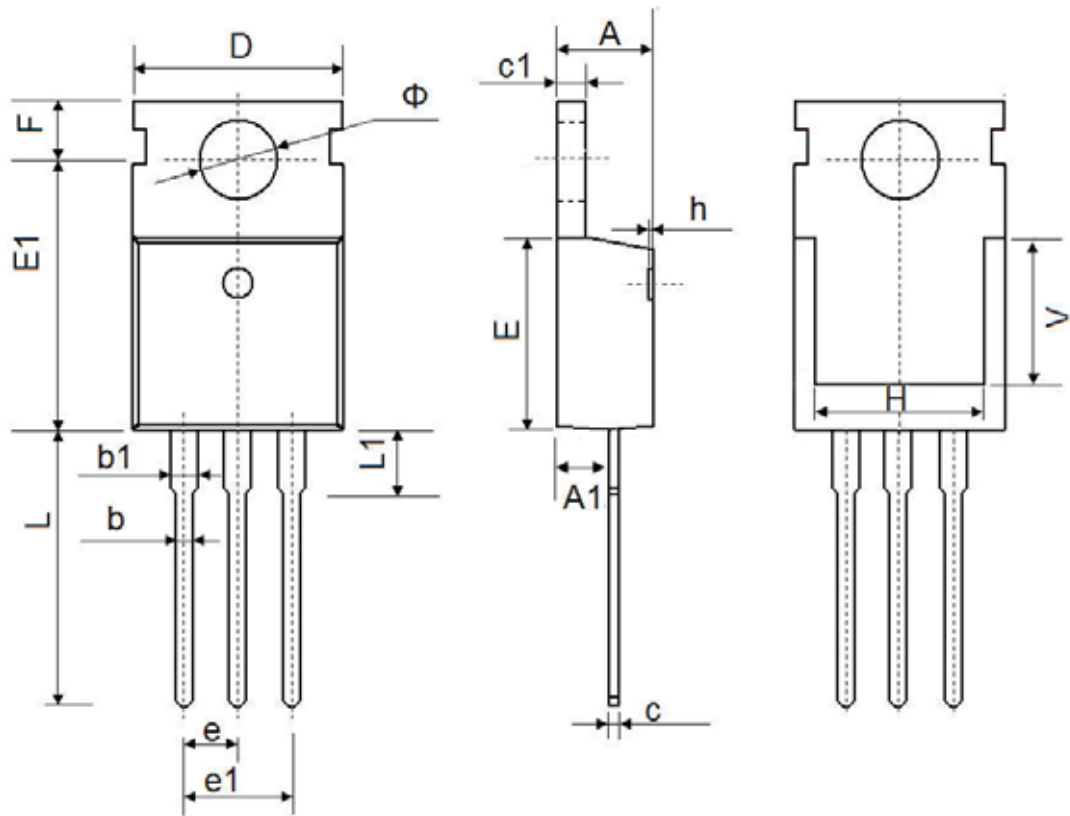

Symbol	Dimensions In Millimeters		Dimensions In Inches	
	Min.	Max.	Min.	Max.
A	4.400	4.600	0.173	0.181
A1	2.250	2.550	0.089	0.100
b	0.710	0.910	0.028	0.036
b1	1.170	1.370	0.046	0.054
c	0.330	0.650	0.013	0.026
c1	1.200	1.400	0.047	0.055
D	9.910	10.250	0.390	0.404
E	8.9500	9.750	0.352	0.384
E1	12.650	12.950	0.498	0.510
e	2.540 TYP.		0.100 TYP.	
e1	4.980	5.180	0.196	0.204
F	2.650	2.950	0.104	0.116
H	7.900	8.100	0.311	0.319
h	0.000	0.300	0.000	0.012
L	12.900	13.400	0.508	0.528
L1	2.850	3.250	0.112	0.128
V	7.500 REF.		0.295 REF.	
Φ	3.400	3.800	0.134	0.150

TO-220F Package Information

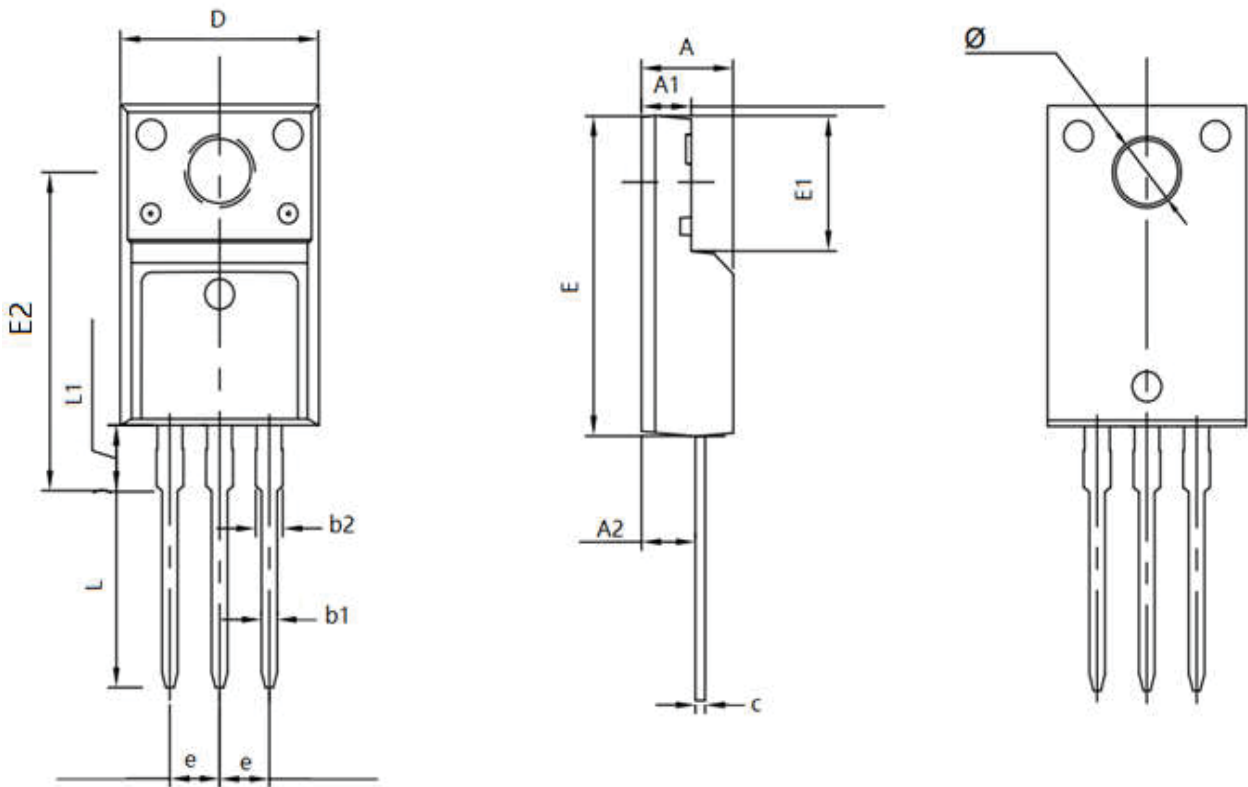

Symbol	Dimensions In Millimeters		Dimensions In Inches	
	Min.	Max.	Min.	Max.
A	4.500	4.900	0.177	0.193
A1	2.340	2.740	0.092	0.108
A2	2.560	2.960	0.101	0.117
b1	0.700	0.900	0.028	0.035
b2	1.180	1.580	0.046	0.062
c	0.400	0.600	0.016	0.024
D	9.960	10.360	0.392	0.408
E	15.670	15.970	0.617	0.629
E1	6.500	6.900	0.256	0.272
E2	15.500	16.100	0.610	0.634
e	2.540 TYP		0.100 TYP	
Φ	3.080	3.280	0.121	0.129
L	12.640	13.240	0.498	0.521
L1	3.030	3.430	0.119	0.135

Package	Tube (pcs/tube)	Tube (pcs/inner box)	Tube (pcs/cartoon)	Tape&Reel (pcs/reel)	Tape&Reel (pcs/inner box)	Tape&Reel (pcs/cartoon)
DFN	100	10,000	100,000	2,500	5,000	40,000
SOP-8	100	10,000	100,000	4,000	4,000	20,000
TSSOP-8	100	32,000	128,000	3,000	6,000	48,000
SOT-23-3L	—	—	—	3,000	30,000	120,000
SOT-23-6L	—	—	—	3,000	30,000	120,000
SOT-23(6R)	—	—	—	3,000	30,000	120,000
SOT-363	—	—	—	3,000	30,000	120,000
SOT-523	—	—	—	3,000	30,000	120,000
SOT223	—	—	—	2,500	2,500	20,000
TO-220	50	1,000	5,000	—	—	—
TO-220F	50	1,000	10,000	—	—	—
TO-247	30	300	1,200	—	—	—
TO-251	80	4,000	40,000	—	—	—
TO-251S(4R)	80	4,000	40,000	—	—	—
TO-252-2L(4R)	80	4,000	40,000	2,500	2,500	25,000
TO-263-2L	50	1,000	10,000	800	800	8,000
TO-3P	30	300	3,000	—	—	—
TO-92	—	—	—	1,000(袋装)	10,000	100,000

DISCLAIMER NOTICE

Rectron Inc reserves the right to make changes without notice to any product specification herein, to make corrections, modifications, enhancements or other changes. Rectron Inc or anyone on its behalf assumes no responsibility or liability for any errors or inaccuracies. Data sheet specifications and its information contained are intended to provide a product description only. "Typical" parameters which may be included on RECTRON data sheets and/ or specifications can and do vary in different applications and actual performance may vary over time. Rectron Inc does not assume any liability arising out of the application or use of any product or circuit.

Rectron products are not designed, intended or authorized for use in medical, life-saving implant or other applications intended for life-sustaining or other related applications where a failure or malfunction of component or circuitry may directly or indirectly cause injury or threaten a life without expressed written approval of Rectron Inc. Customers using or selling Rectron components for use in such applications do so at their own risk and shall agree to fully indemnify Rectron Inc and its subsidiaries harmless against all claims, damages and expenditures.