

## SUMMARY



Image is for illustrative purpose only

### # Wires

Low voltage 3

|                  |                                    |
|------------------|------------------------------------|
| Series           | 0B                                 |
| Termination type | Male solder                        |
| IP rating        | 50                                 |
| AWG wire size    | 28.00 - 20.00                      |
| Cable Ø          | 0.00 - 0.00 mm                     |
| Status           | active                             |
| Matching parts   | <a href="#">PHG.0B.303.CLLD32Z</a> |

### Download

[Request a quote](#)

[Catalog](#)

## TECHNICAL DETAILS

### Mechanics

|                   |   |
|-------------------|---|
| Shell Style/Model | FA*: Fixed plug, non-latching, nut fixing   |
| Keying            | 1 key (alpha=0, plug: male contacts, receptacle: female contacts)   |
| Housing Material  | Brass (chrome plated [SAE AMS 2460]) shell and collet nut, nickel plated [SAE AMS QQ N 290] brass latch sleeve and mid pieces |
| Weight            | 5.09 g  |

### Performance

|               |                           |
|---------------|---------------------------|
| Configuration | 0B.303 : 3 Low Voltage    |
| Insulator     | L: PEEK (UL 94 / V-0/1.5) |
| Rated Current | 8 Amps                    |

### Specifications

|                          |                               |
|--------------------------|-------------------------------|
| Contact Type:            | Solder                        |
| Contact Dia.:            | 0.9 mm (0.035in)              |
| Bucket Dia.:             | 1.0 mm (0.039in)              |
| Max. Solid Conductor:    | 0.56 mm <sup>2</sup> (AWG 20) |
| Max. Stranded Conductor: | 0.56 mm <sup>2</sup> (AWG 20) |
| R (max):                 | 4.8 mOhm                      |
| Vtest (contact-shell):   | 900 V (AC), 1270 V (DC)       |
| Vtest (contact-contact): | 1200 V (AC), 1700 V (DC)      |

LEMO products and services are provided "as is". LEMO makes no warranties or representations with regard to LEMO product & services or use of them, express, implied or statutory, including for accuracy, completeness, or security. The user is fully responsible for his products and applications using LEMO components.

## Others

Endurance (Shell): 5000  
 Temp (min / max): -55°C / +250°C  
 Humidity (max): <=95% [at 60 deg C / 140 F]  
 Vibration: 15 g [10 Hz - 2000 Hz]  
 Shock Resistance: 100 g [ 6 ms]  
 Climatical Category: 50/175/21  
 Shielding (min): 75 dB (10 MHz)  
 Shielding (min): 40 dB (1 GHz)  
 Salt Spray Corrosion: >1000 hr

## DRAWINGS

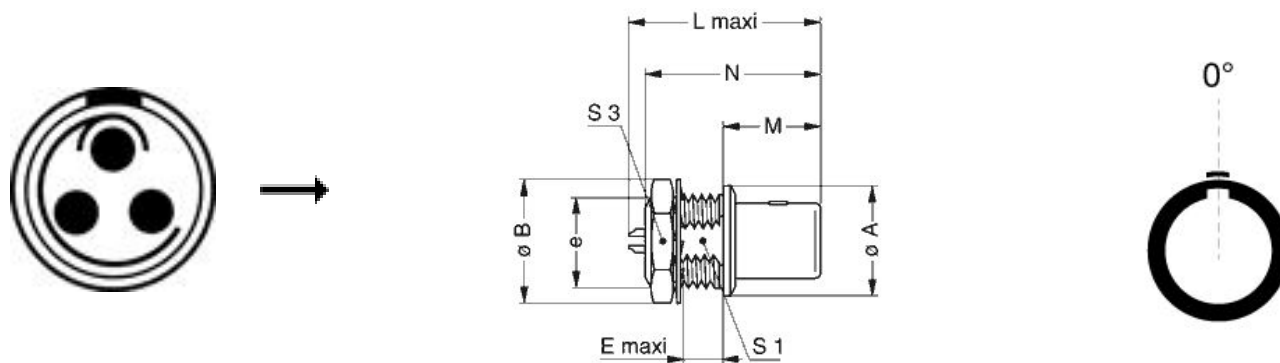

## Dimensions











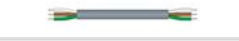

|     | A    | B    | E    | L    | M    | N    | S1   | S3   | e      |
|-----|------|------|------|------|------|------|------|------|--------|
| mm. | 10   | 12.5 | 4.2  | 20.8 | 11.5 | 18.9 | 8.2  | 11   | M9x0.6 |
| in. | 0,39 | 0,49 | 0,17 | 0,82 | 0,45 | 0,74 | 0,32 | 0,43 |        |

## RECOMMENDED BY LEMO

### Tools

*LEMO products and services are provided "as is". LEMO makes no warranties or representations with regard to LEMO product & services or use of them, express, implied or statutory, including for accuracy, completeness, or security. The user is fully responsible for his products and applications using LEMO components.*

## Cables

|                    |     |       |  |
|--------------------|-----|-------|--|
| CMN.03.T28.031PGCE | PVC | GREY  |  |
| CMN.03.T28.031PGZE |     | Grey  |  |
| CMN.03.T28.031PNCE | PVC | Black |  |
| CMN.03.T28.031PNZE |     |       |  |
| 130240             | PVC | Black |  |
| 130250             | PVC | Grey  |  |
| 30110              | PVC | Grey  |  |
| 30141              | PVC | Grey  |  |
| 30260              | PVC | Black |  |
| 3041               | PVC | Grey  |  |
| 3050               | PVC | Black |  |
| 3081               | PVC | Black |  |
| 3220               | PVC | Black |  |
| 3280               | PVC | Black |  |
| 60080              | PVC | Grey  |  |

LEMO products and services are provided "as is". LEMO makes no warranties or representations with regard to LEMO product & services or use of them, express, implied or statutory, including for accuracy, completeness, or security. The user is fully responsible for his products and applications using LEMO components.