

Pitch Changer 1.27mm to 2.54mm conversion - 4 Pin

| REF. | DIMENSIONS | | | | | | Pin Count |
|------|------------|------|------|--------|------|------|-----------|
| | mm | | | inches | | | |
| | MIN. | TYP. | MAX. | MIN. | TYP. | MAX. | |
| E1 | | 1.27 | | | | | |
| E2 | | 2.54 | | | | | |
| H1 | | 0.64 | | | | | |
| H2 | | 1.00 | | | | | |
| n | | | | | | | 4 |

Top View (TH Footprints)

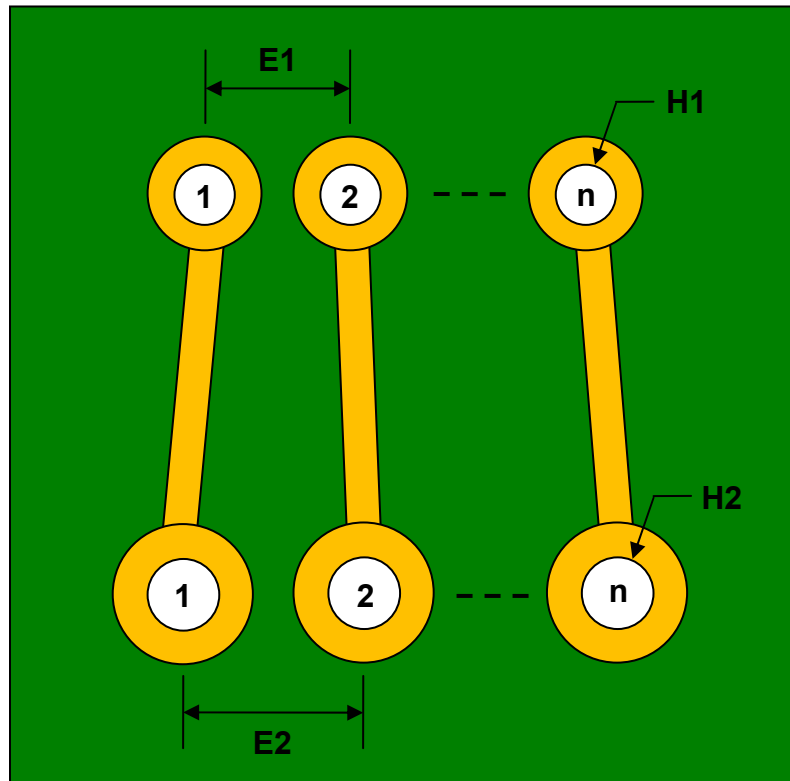

(Representative drawing only - not to scale)

Part Number Coding

From Pitch (mm): 1.00, 1.27, 2.00, 2.54

To Pitch (mm): 1.00, 1.27, 2.00, 2.54

Pin Count: 4, 5, 6, 8, 10, 16, 20

Rule: From Pitch ≤ To Pitch

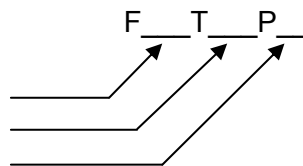

Orderable Part Numbers

| Part Number | From Pitch | To Pitch | Pin Count |
|-------------|------------|----------|-----------|
| F100T100P04 | 1.00mm | 1.00mm | 4 |
| F100T100P05 | 1.00mm | 1.00mm | 5 |
| F100T100P06 | 1.00mm | 1.00mm | 6 |
| F100T100P08 | 1.00mm | 1.00mm | 8 |
| F100T100P10 | 1.00mm | 1.00mm | 10 |
| F100T100P16 | 1.00mm | 1.00mm | 16 |
| F100T100P20 | 1.00mm | 1.00mm | 20 |
| F100T127P04 | 1.00mm | 1.27mm | 4 |
| F100T127P05 | 1.00mm | 1.27mm | 5 |
| F100T127P06 | 1.00mm | 1.27mm | 6 |
| F100T127P08 | 1.00mm | 1.27mm | 8 |
| F100T127P10 | 1.00mm | 1.27mm | 10 |
| F100T127P16 | 1.00mm | 1.27mm | 16 |
| F100T127P20 | 1.00mm | 1.27mm | 20 |
| F100T200P04 | 1.00mm | 2.00mm | 4 |
| F100T200P05 | 1.00mm | 2.00mm | 5 |
| F100T200P06 | 1.00mm | 2.00mm | 6 |
| F100T200P08 | 1.00mm | 2.00mm | 8 |
| F100T200P10 | 1.00mm | 2.00mm | 10 |
| F100T200P16 | 1.00mm | 2.00mm | 16 |
| F100T200P20 | 1.00mm | 2.00mm | 20 |
| F100T254P04 | 1.00mm | 2.54mm | 4 |
| F100T254P05 | 1.00mm | 2.54mm | 5 |
| F100T254P06 | 1.00mm | 2.54mm | 6 |
| F100T254P08 | 1.00mm | 2.54mm | 8 |
| F100T254P10 | 1.00mm | 2.54mm | 10 |
| F100T254P16 | 1.00mm | 2.54mm | 16 |
| F100T254P20 | 1.00mm | 2.54mm | 20 |
| F127T127P04 | 1.27mm | 1.27mm | 4 |
| F127T127P05 | 1.27mm | 1.27mm | 5 |
| F127T127P06 | 1.27mm | 1.27mm | 6 |
| F127T127P08 | 1.27mm | 1.27mm | 8 |
| F127T127P10 | 1.27mm | 1.27mm | 10 |
| F127T127P16 | 1.27mm | 1.27mm | 16 |
| F127T127P20 | 1.27mm | 1.27mm | 20 |

| Part Number | From Pitch | To Pitch | Pin Count |
|-------------|------------|----------|-----------|
| F127T200P04 | 1.27mm | 2.00mm | 4 |
| F127T200P05 | 1.27mm | 2.00mm | 5 |
| F127T200P06 | 1.27mm | 2.00mm | 6 |
| F127T200P08 | 1.27mm | 2.00mm | 8 |
| F127T200P10 | 1.27mm | 2.00mm | 10 |
| F127T200P16 | 1.27mm | 2.00mm | 16 |
| F127T200P20 | 1.27mm | 2.00mm | 20 |
| F127T254P04 | 1.27mm | 2.54mm | 4 |
| F127T254P05 | 1.27mm | 2.54mm | 5 |
| F127T254P06 | 1.27mm | 2.54mm | 6 |
| F127T254P08 | 1.27mm | 2.54mm | 8 |
| F127T254P10 | 1.27mm | 2.54mm | 10 |
| F127T254P16 | 1.27mm | 2.54mm | 16 |
| F127T254P20 | 1.27mm | 2.54mm | 20 |
| F200T200P04 | 2.00mm | 2.00mm | 4 |
| F200T200P05 | 2.00mm | 2.00mm | 5 |
| F200T200P06 | 2.00mm | 2.00mm | 6 |
| F200T200P08 | 2.00mm | 2.00mm | 8 |
| F200T200P10 | 2.00mm | 2.00mm | 10 |
| F200T200P16 | 2.00mm | 2.00mm | 16 |
| F200T200P20 | 2.00mm | 2.00mm | 20 |
| F200T254P04 | 2.00mm | 2.54mm | 4 |
| F200T254P05 | 2.00mm | 2.54mm | 5 |
| F200T254P06 | 2.00mm | 2.54mm | 6 |
| F200T254P08 | 2.00mm | 2.54mm | 8 |
| F200T254P10 | 2.00mm | 2.54mm | 10 |
| F200T254P16 | 2.00mm | 2.54mm | 16 |
| F200T254P20 | 2.00mm | 2.54mm | 20 |
| F254T254P04 | 2.54mm | 2.54mm | 4 |
| F254T254P05 | 2.54mm | 2.54mm | 5 |
| F254T254P06 | 2.54mm | 2.54mm | 6 |
| F254T254P08 | 2.54mm | 2.54mm | 8 |
| F254T254P10 | 2.54mm | 2.54mm | 10 |
| F254T254P16 | 2.54mm | 2.54mm | 16 |
| F254T254P20 | 2.54mm | 2.54mm | 20 |