

THIS IS A C.A.D. GENERATED DRAWING
DO NOT MAKE MANUAL REVISIONS TO MASTER.

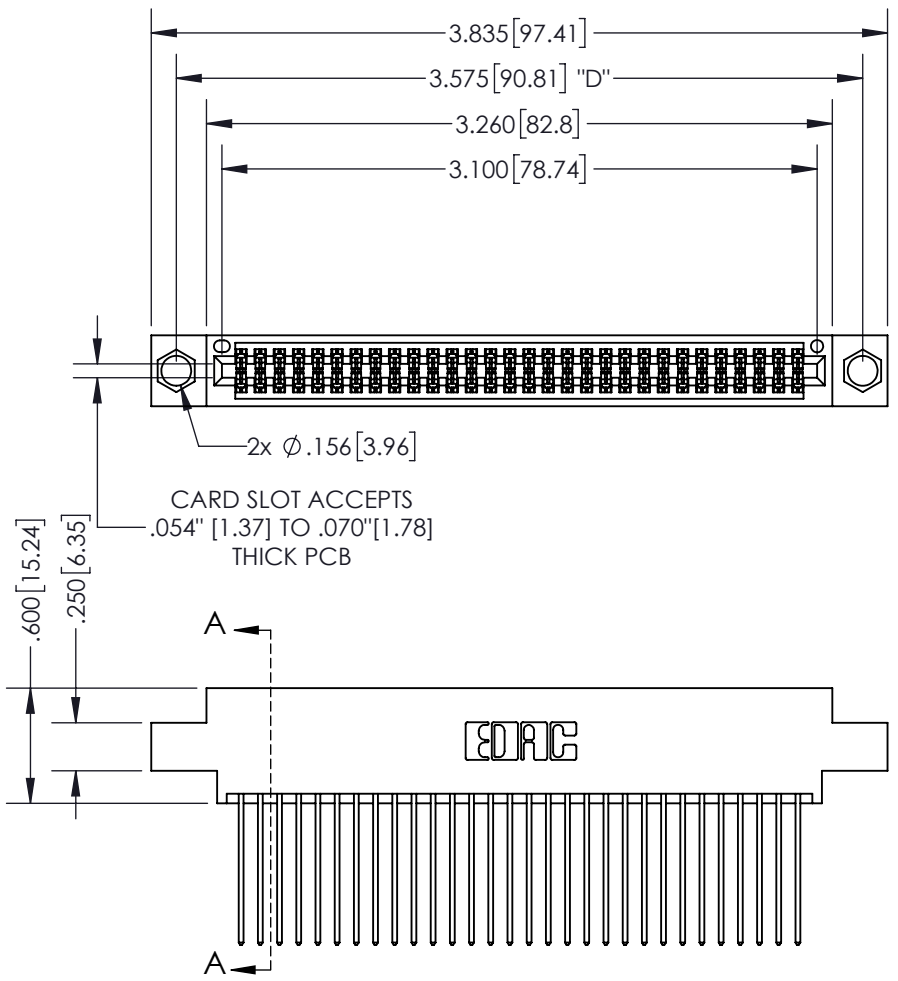

ISSUE NUMBER	
ORIGINAL	①



Contact Dimensions:
541-Wire Wrap .025 Sq.(0.64 Sq.) - Tail
LG=.750(19.05)
.100 (2.54) Contact Spacing x .200 (5.08)
Row Spacing

INSULATOR MATERIAL: THERMOPLASTIC PBT, UL 94V-0
 CONTACT MATERIAL: COPPER TIN ALLOY
 CONTACT PLATING: GOLD ON THE MATING AREA, TIN PLATING
 ON THE CONTACT TAILS, NICKEL UNDERPLATE

345/395 SERIES CARD EDGE CONNECTOR
PART NUMBER: 395-060-541-804

 EDAC INC TORONTO, ONTARIO CANADA YOUR CONNECTION TO QUALITY & SERVICE	THESE DRAWINGS AND SPECIFICATIONS ARE THE PROPERTY OF EDAC INC. AND SHALL NOT BE REPRODUCED, OR COPIED OR USED AS THE BASIS FOR THE MANUFACTURE OR SALE OF APPARATUS WITHOUT WRITTEN PERMISSION.	<table border="1" style="width: 100%; font-size: x-small;"> <tr> <td>ACAD REFERENCE NO.</td> <td>345-ENG-MASTER</td> </tr> <tr> <td>DRAWN: R.STA.MONICA</td> <td>DATE: MAY.16/2017</td> </tr> <tr> <td>CHECKED:</td> <td>DATE:</td> </tr> <tr> <td>SCALE: 1:1</td> <td>SHEET 1 OF 2</td> </tr> <tr> <td>DRAWING NUMBER</td> <td>ISSUE</td> </tr> <tr> <td style="text-align: center;">345-ENG-MASTER</td> <td style="text-align: center;">1</td> </tr> </table>	ACAD REFERENCE NO.	345-ENG-MASTER	DRAWN: R.STA.MONICA	DATE: MAY.16/2017	CHECKED:	DATE:	SCALE: 1:1	SHEET 1 OF 2	DRAWING NUMBER	ISSUE	345-ENG-MASTER	1
ACAD REFERENCE NO.	345-ENG-MASTER													
DRAWN: R.STA.MONICA	DATE: MAY.16/2017													
CHECKED:	DATE:													
SCALE: 1:1	SHEET 1 OF 2													
DRAWING NUMBER	ISSUE													
345-ENG-MASTER	1													

THIS IS A C.A.D. GENERATED DRAWING
DO NOT MAKE MANUAL REVISIONS TO MASTER.



ISSUE NUMBER	
ORIGINAL	①



Contact Code 555



Contact Code 556



Contact Code 558



Contact Code 559



Contact Code 560

345/395 SERIES CARD EDGE CONNECTOR CONTACT CODE 555,556,558,559,560 DIMENSIONS		ACAD REFERENCE NO.	345-ENG-MASTER
		DRAWN: R.STA.MONICA	DATE: MAY.16/2017
 EDAC INC TORONTO, ONTARIO CANADA YOUR CONNECTION TO QUALITY & SERVICE		CHECKED:	DATE:
		SCALE: 1:1	SHEET 2 OF 2
THESE DRAWINGS AND SPECIFICATIONS ARE THE PROPERTY OF EDAC INC. AND SHALL NOT BE REPRODUCED, OR COPIED OR USED AS THE BASIS FOR THE MANUFACTURE OR SALE OF APPARATUS WITHOUT WRITTEN PERMISSION.		DRAWING NUMBER	ISSUE
		345-ENG-MASTER	1