

**PLUG MATED TO R/A RECEPTACLE  
MATED PROFILE**

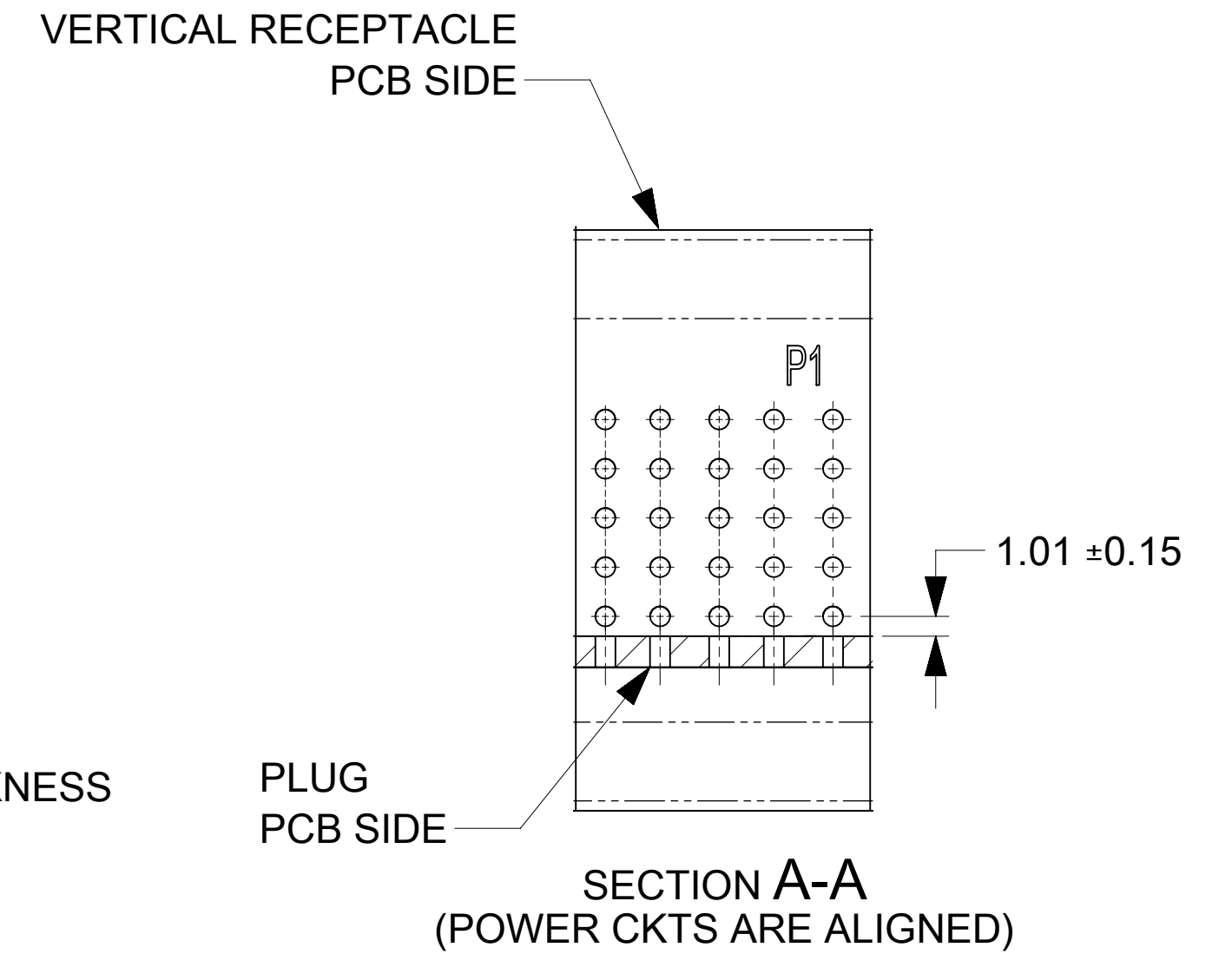

**PLUG MATED TO VERTICAL RECEPTACLE  
MATED PROFILE**

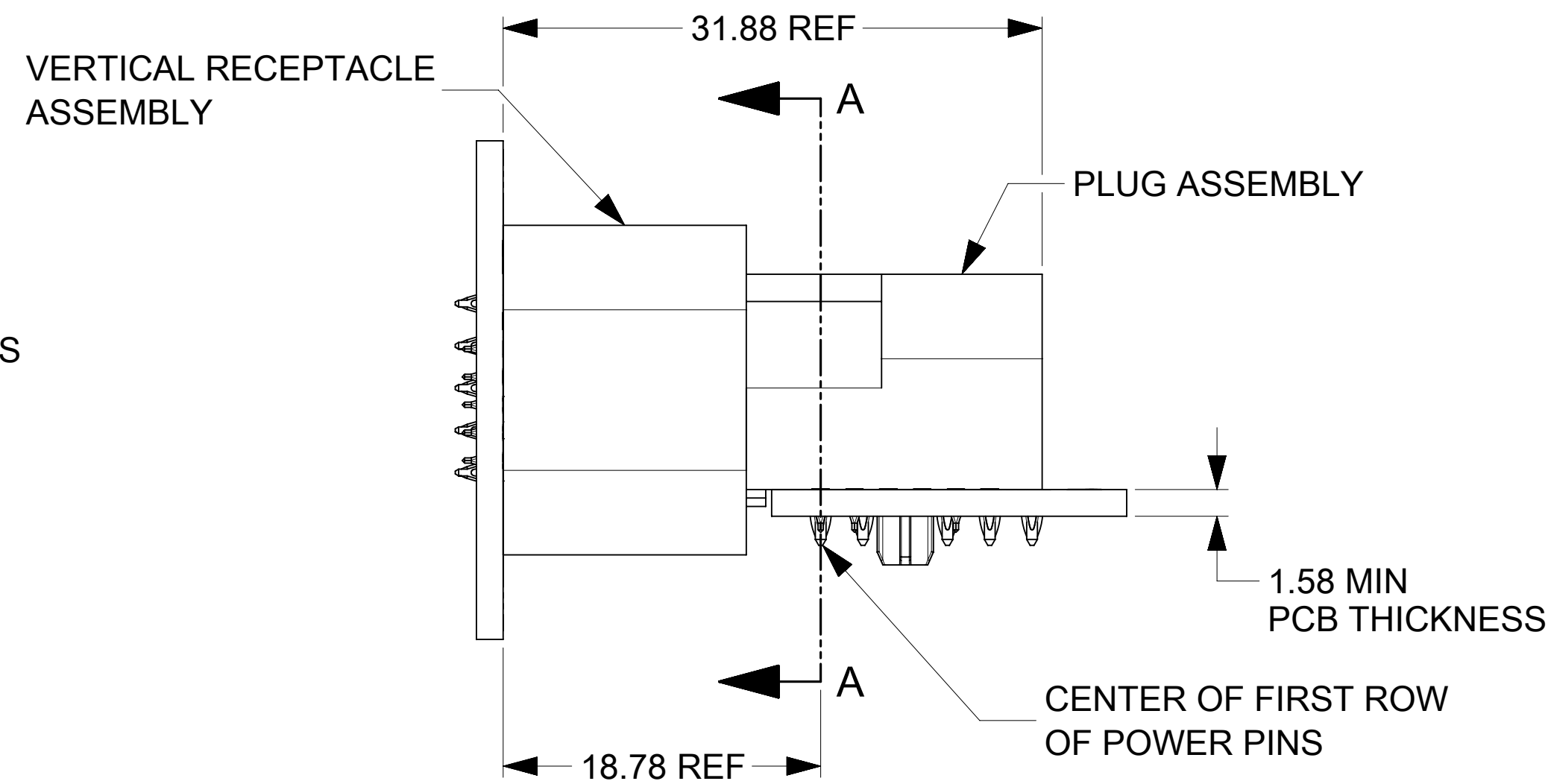
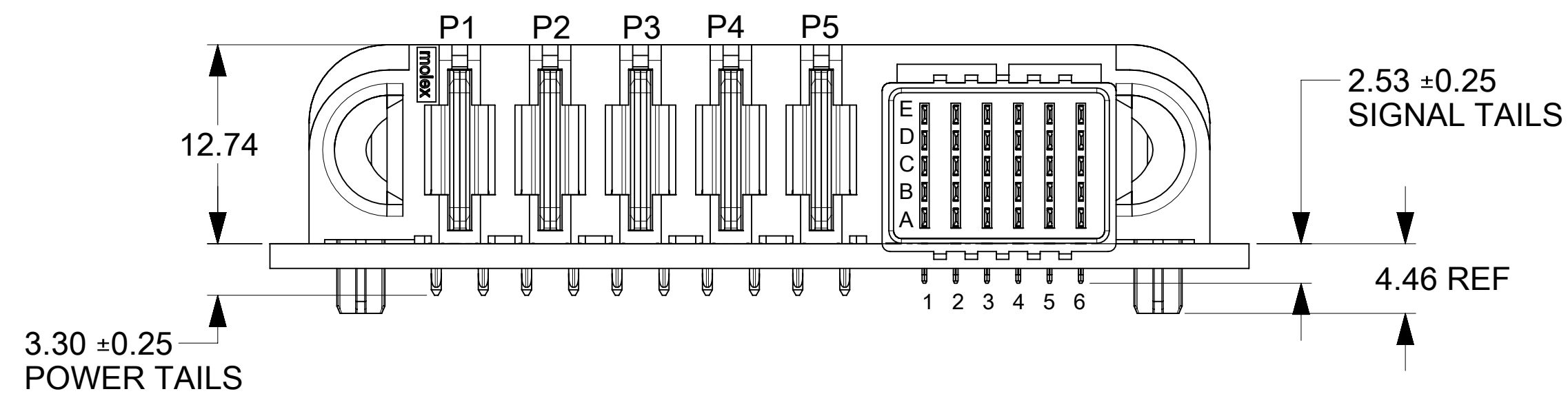
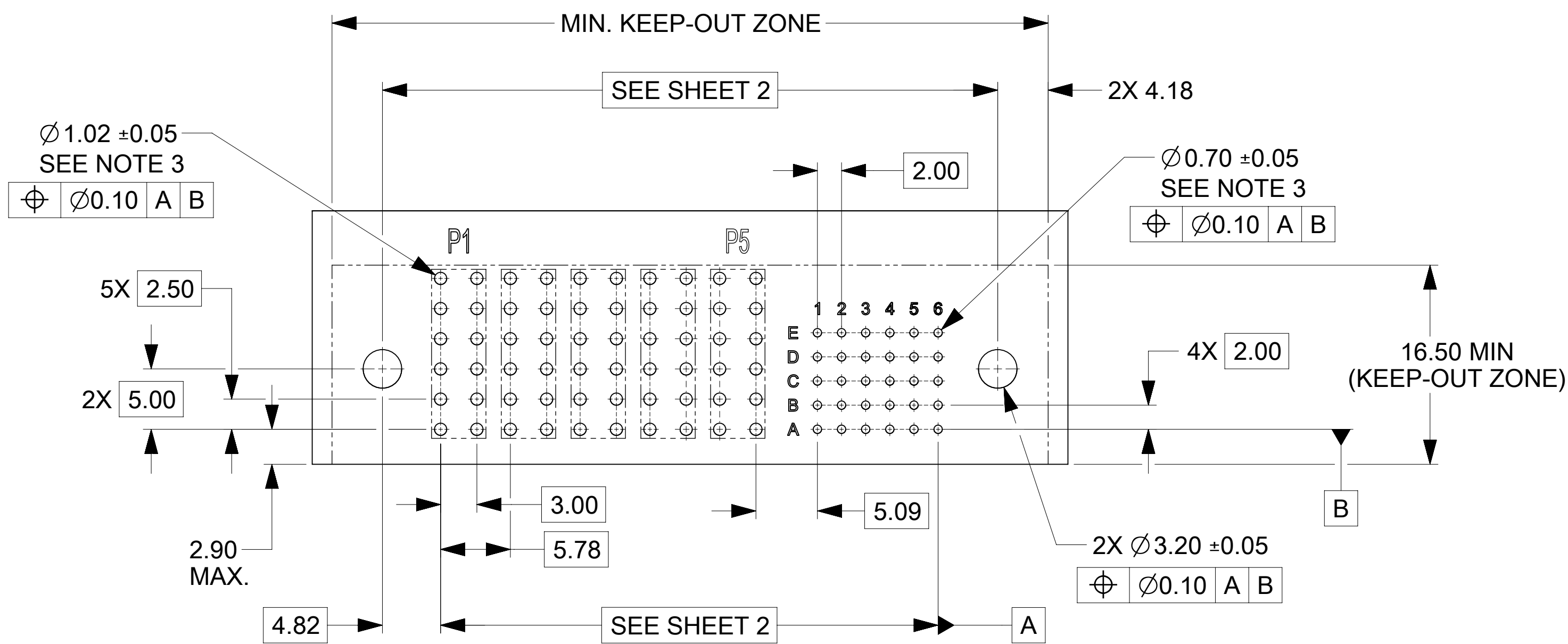

**NOTES:**

- MATERIAL:**
  - HOUSINGS: LCP UL94, V-0, COLOR : BLACK
  - TERMINALS: HIGH CONDUCTIVITY COPPER ALLOY
  - PLATING: 1.27 µm (50 µin) NICKEL OVERALL WITH 2.54 µm (100 µin) SELECTIVE TIN ON TAILS AND 0.762 µm (30 µin) SELECTIVE GOLD ON CONTACT AREA
- PACKAGING:** ASSEMBLIES TO BE TRAY PACKED PER PACKAGING SPEC: 2141130010-PK.
- PLATED THRU HOLE SIZE,** REFER TO PRODUCT SPEC. FOR DETAILS.
- PRODUCT SPEC:** 2141130000-PS.
- PRODUCT TO MEET** RoHS REQUIREMENTS.
- PLUG ASSEMBLY MATES TO MOLEX RECEPTACLES** 219563XXXX-SD AND 219564XXXX-SD, SEE DRAWINGS FOR DETAILS.
- TAIL DESIGN:** COMPLIANT PIN.
- POWER TERMINALS AND SIGNALS ARE LUBRICATED.**
- APPLICATION SPECIFICATION:** 2141130000-AS (FOR COMPLIANT TAILS ONLY).

THIS DRAWING CONTAINS INFORMATION THAT IS PROPRIETARY TO MOLEX ELECTRONIC TECHNOLOGIES, LLC AND SHOULD NOT BE USED WITHOUT WRITTEN PERMISSION									
DIMENSION UNITS		SCALE		CURRENT REV DESC:					
mm		3:1							
GENERAL TOLERANCES (UNLESS SPECIFIED)				EC NO: 745288					
ANGULAR TOL ± °				DRWN: LZABJANOVSKI		2023/03/09		GUARDIAN HD RA PLUG RIGHT SIGNAL WITH POWER PF	
4 PLACES ±				CHK'D: JAYK1		2023/04/10		PRODUCT CUSTOMER DRAWING	
3 PLACES ±				APPR: JAYK1		2023/04/10		DOCUMENT NUMBER	
2 PLACES ± 0.25				INITIAL REVISION:				DOC TYPE	
1 PLACE ± 0.3				DRWN: LZABJANOVSKI		2022/03/14		DOC PART	
0 PLACES ±				APPR: BPISZCZOR		2022/08/04		REVISION	
DRAFT WHERE APPLICABLE MUST REMAIN WITHIN DIMENSIONS				THIRD ANGLE PROJECTION		DRAWING		SERIES	
				D-SIZE		219562		MATERIAL NUMBER	
				SEE CHART		CUSTOMER		SHEET NUMBER	
								1 OF 2	

**RECOMMENDED PCB LAYOUT AND KEEP-OUT ZONE**

PART NUMBER	CONFIGURATION	QUANTITY PER CARTON (DU)
219562-0011	G+1P+15S+G	135

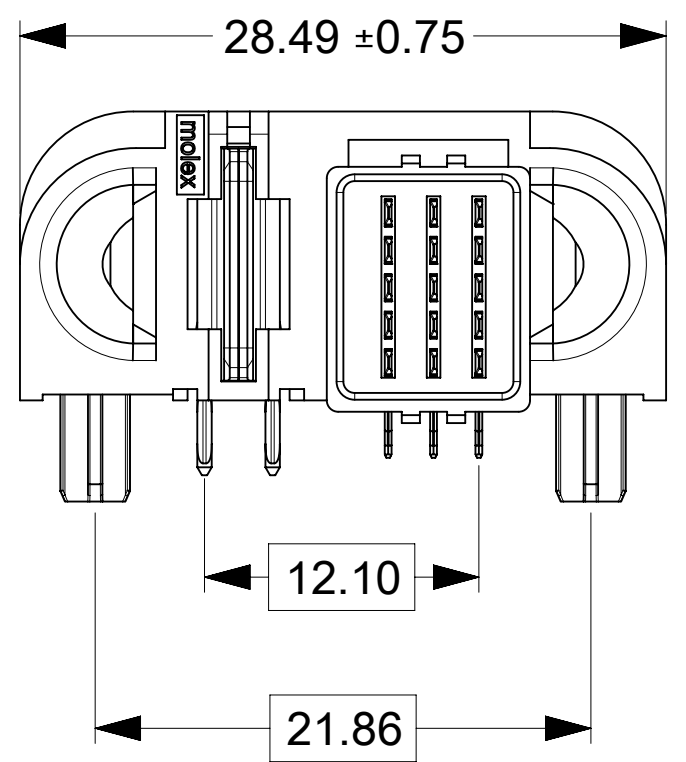

PART NUMBER	CONFIGURATION	QUANTITY PER CARTON (DU)
219562-0012	G+2P+15S+G	105

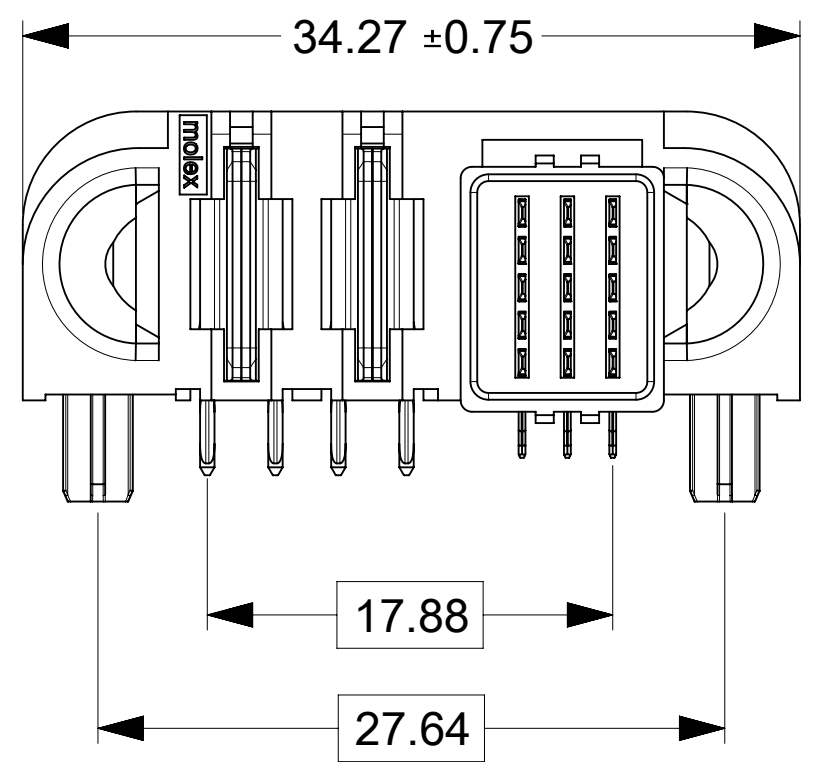

PART NUMBER	CONFIGURATION	QUANTITY PER CARTON (DU)
219562-0013	G+3P+15S+G	90

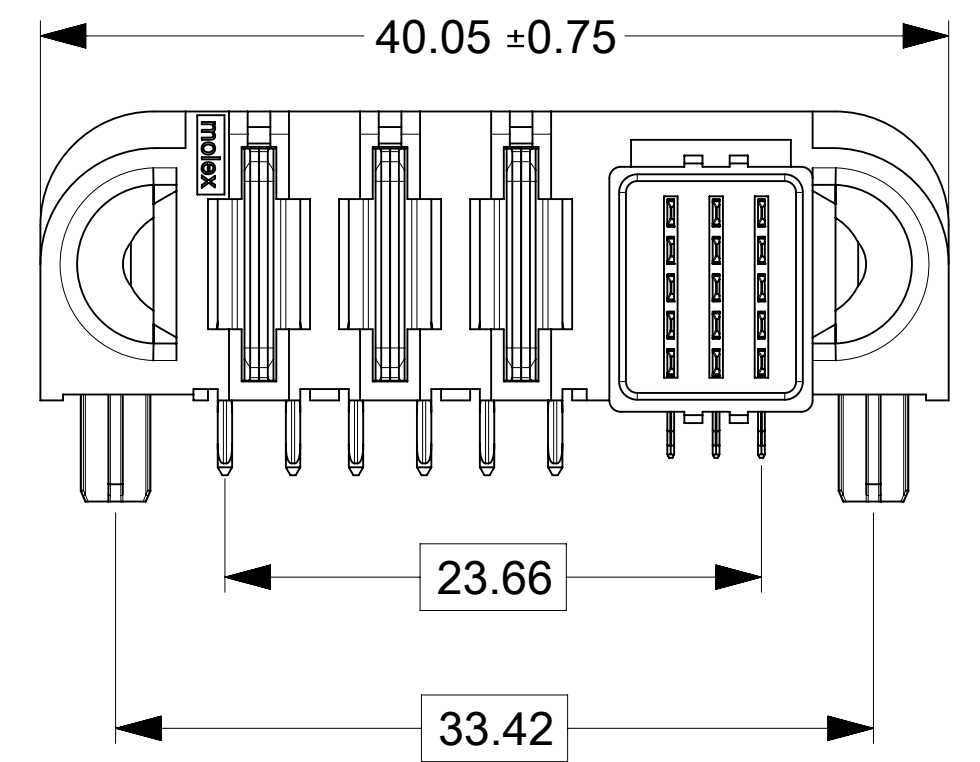

PART NUMBER	CONFIGURATION	QUANTITY PER CARTON (DU)
219562-0014	G+4P+15S+G	75

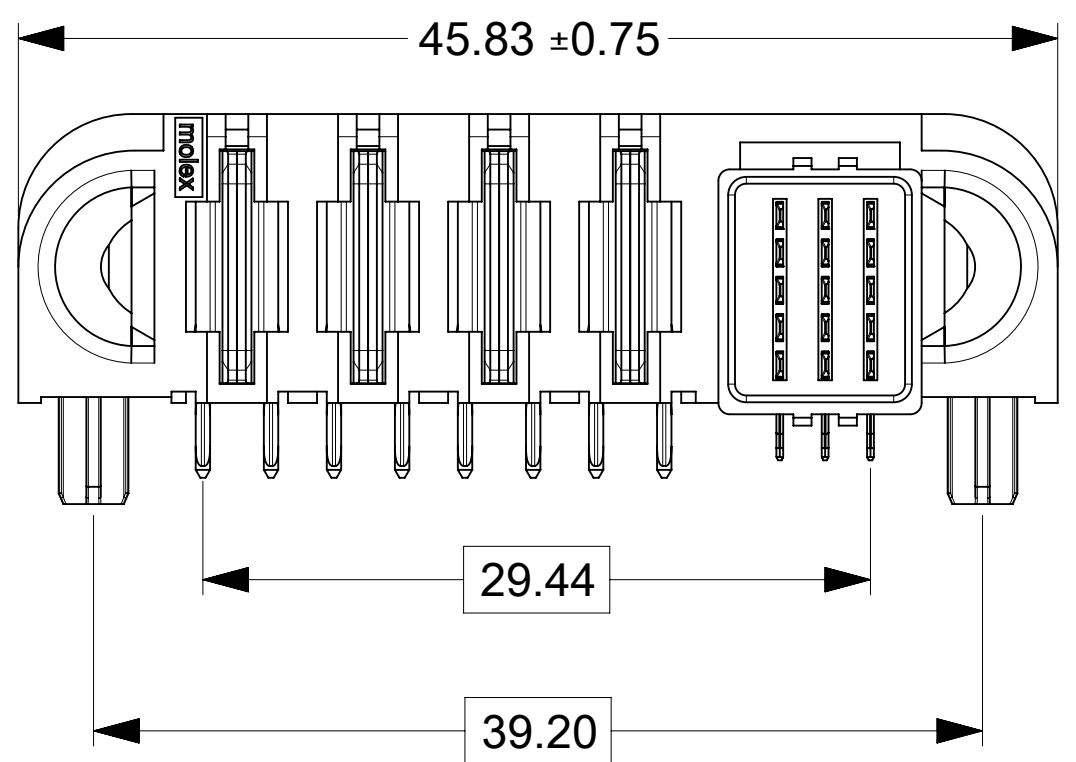

PART NUMBER	CONFIGURATION	QUANTITY PER CARTON (DU)
219562-0015	G+5P+15S+G	75

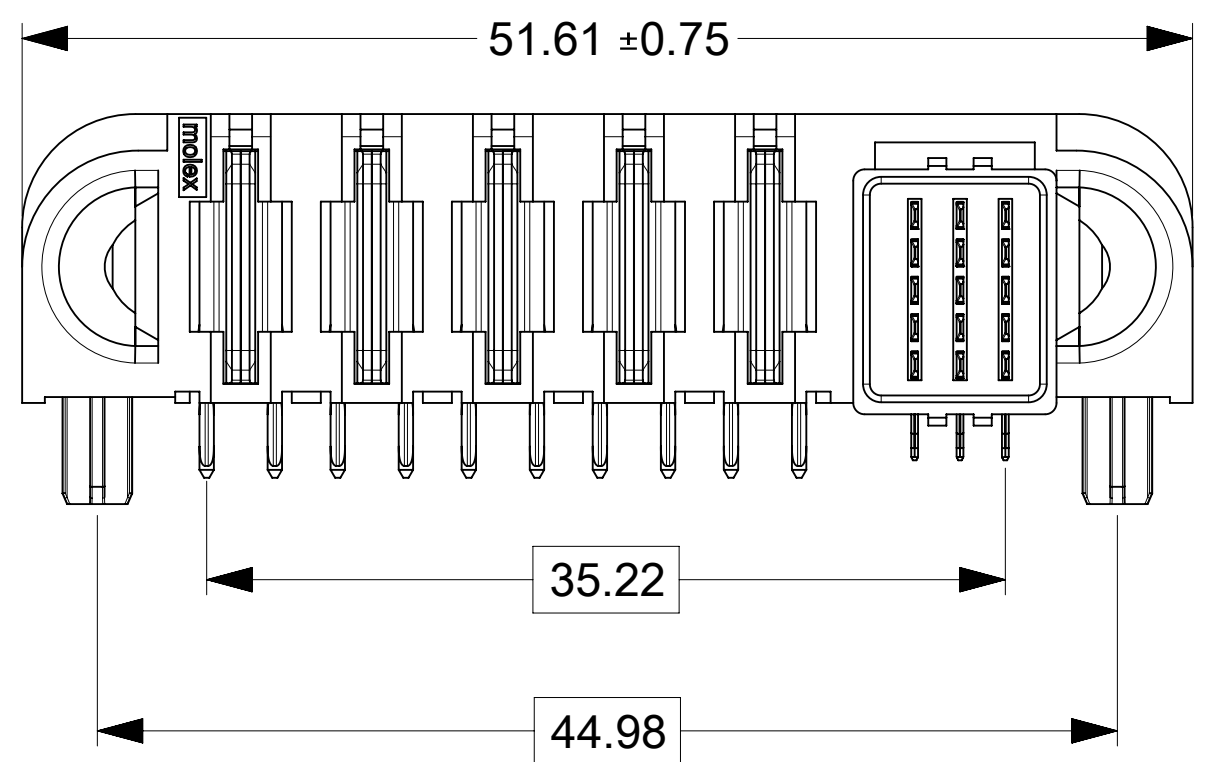

PART NUMBER	CONFIGURATION	QUANTITY PER CARTON (DU)
219562-0016	G+1P+30S+G	105

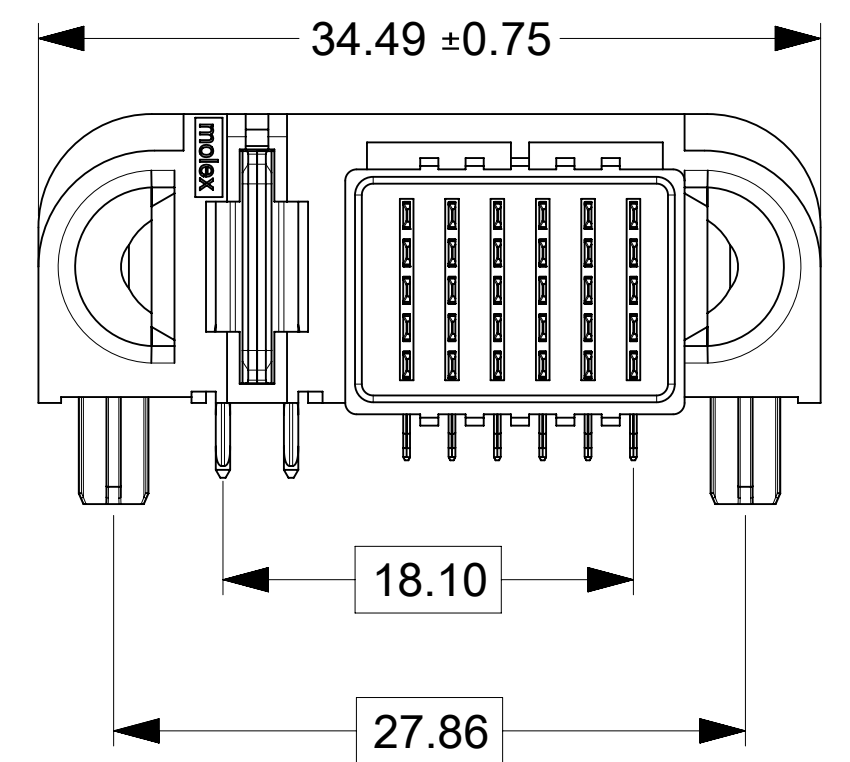

PART NUMBER	CONFIGURATION	QUANTITY PER CARTON (DU)
219562-0017	G+2P+30S+G	90

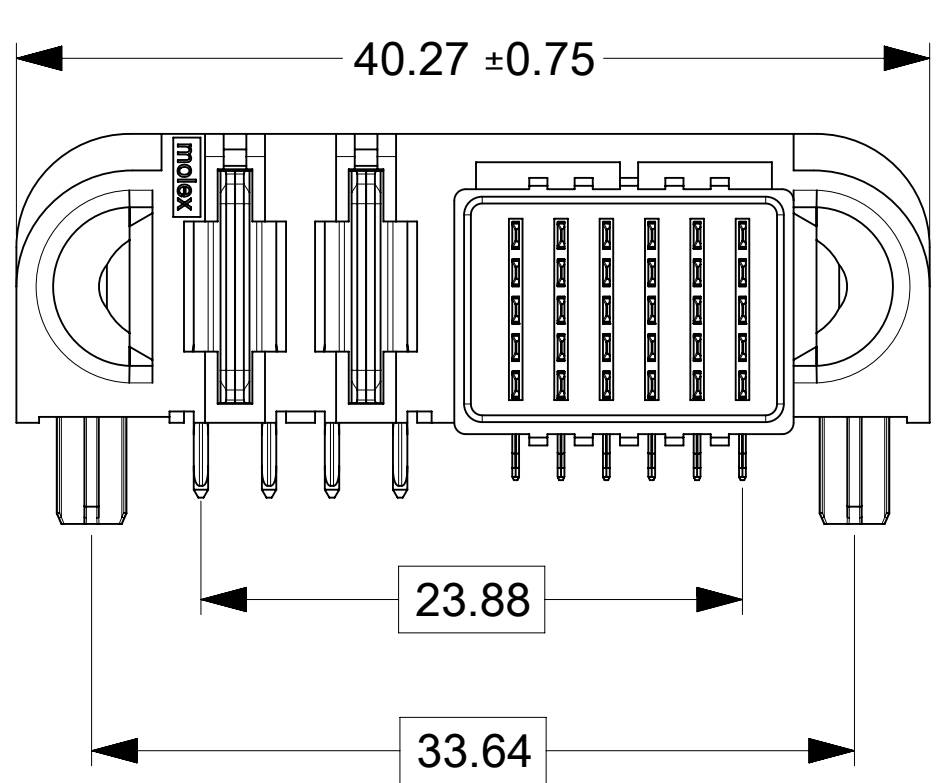

PART NUMBER	CONFIGURATION	QUANTITY PER CARTON (DU)
219562-0018	G+3P+30S+G	75

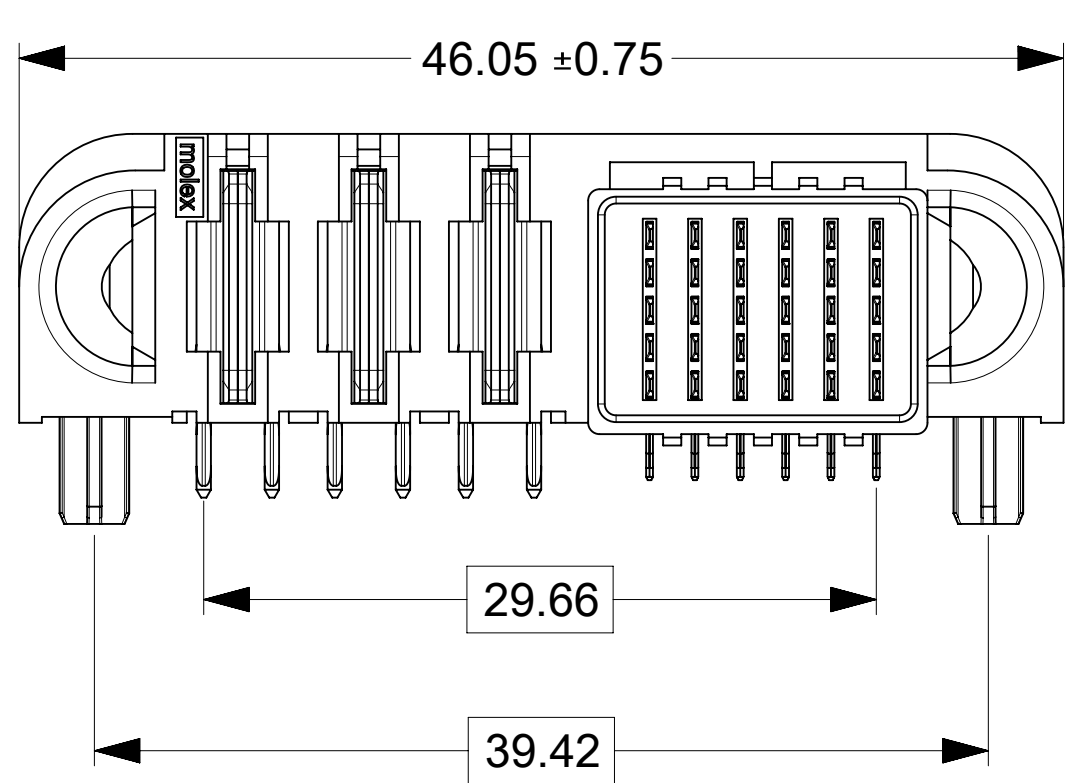

PART NUMBER	CONFIGURATION	QUANTITY PER CARTON (DU)
219562-0019	G+4P+30S+G	75

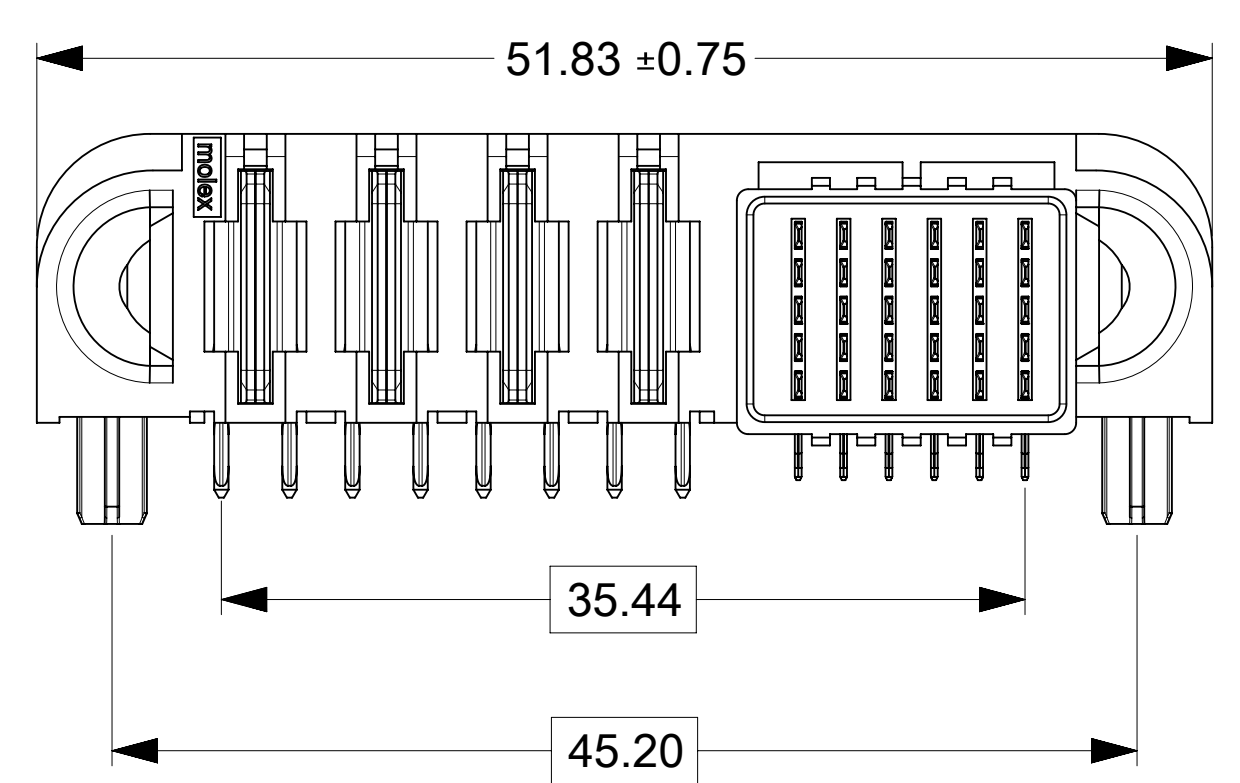

PART NUMBER	CONFIGURATION	QUANTITY PER CARTON (DU)
219562-0020	G+5P+30S+G	60

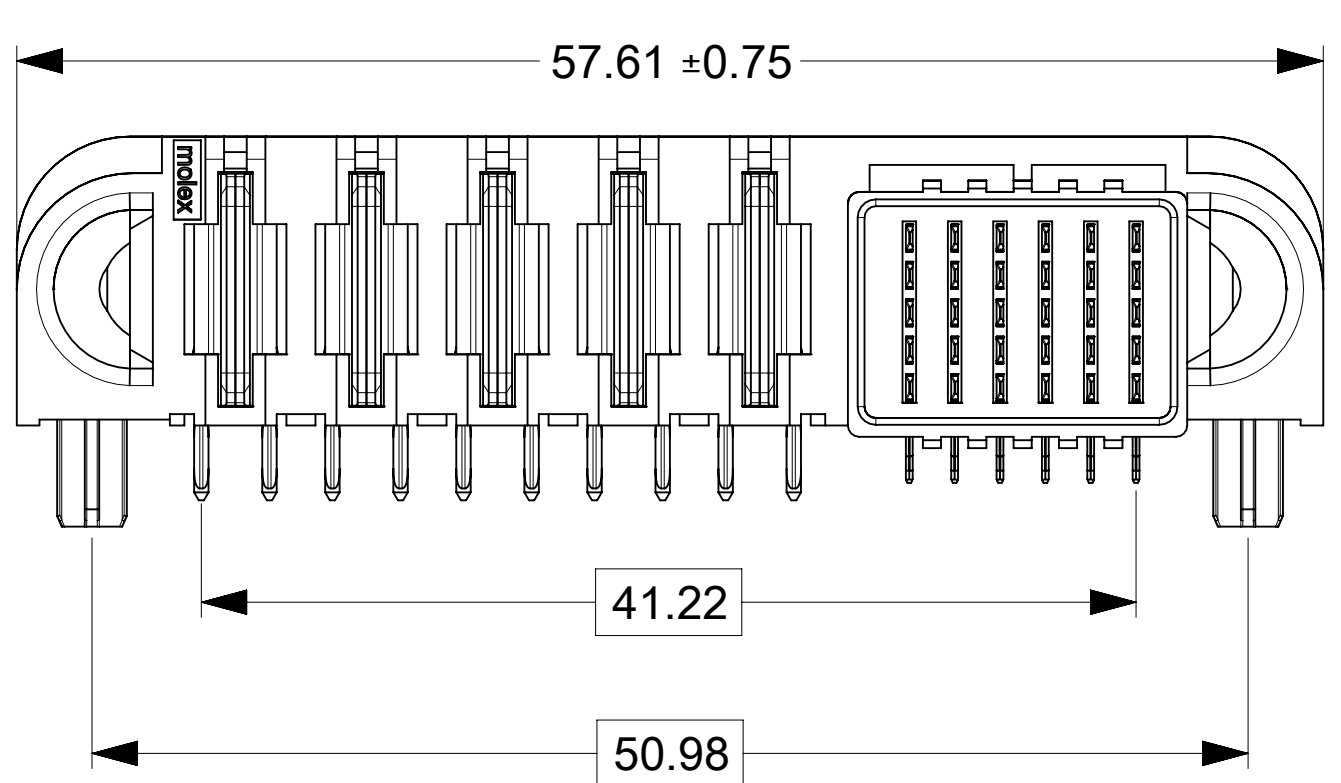

THIS DRAWING CONTAINS INFORMATION THAT IS PROPRIETARY TO MOLEX ELECTRONIC TECHNOLOGIES, LLC AND SHOULD NOT BE USED WITHOUT WRITTEN PERMISSION

DIMENSION UNITS	SCALE	CURRENT REV DESC:	
mm	3:1		
GENERAL TOLERANCES (UNLESS SPECIFIED)			
ANGULAR TOL	±	°	
4 PLACES	±		
3 PLACES	±		
2 PLACES	±	0.25	
1 PLACE	±	0.3	
0 PLACES	±		
DRAFT WHERE APPLICABLE MUST REMAIN WITHIN DIMENSIONS		THIRD ANGLE PROJECTION	DRAWING SERIES
			D-SIZE 219562

EC NO: 745288			
DRWN: LZABJANOVSKI	2023/03/09		
CHK'D: JAYK1	2023/04/10		
APPR: JAYK1	2023/04/10		
INITIAL REVISION:			
DRWN: LZABJANOVSKI	2022/03/14		
APPR: BPISZCZOR	2022/08/04		

DOCUMENT NUMBER		DOC TYPE	DOC PART	REVISION
2195629001-SD		PSD	000	A1
MATERIAL NUMBER		CUSTOMER		SHEET NUMBER
SEE CHART				2 OF 2

**molex**

GUARDIAN HD RA PLUG RIGHT SIGNAL WITH POWER PF

PRODUCT CUSTOMER DRAWING

DOCUMENT STATUS	P1	RELEASE DATE	2023/04/11 17:04:40
-----------------	----	--------------	---------------------