



VTDV4M190dCPA DV4 19" Monitor

VarTech's flagship DiamondVue series of touchscreen monitor displays is available in various mechanical/mounting designs.

The adaptive design of DiamondVue monitors enables the same mechanical footprint for standalone displays and panel computers alike, expanding versatility to a wider range of industrial, commercial, and military applications.

New clip mount bezel options offer a slimmer design, and displays are easily mounted without having to drill holes. Available with standard or sunlight readable LCD screens these screens are perfectly suited for improved visibility and operability of HMI interfaces and process controls.

Features

- Industrial-grade LED back-lit LCD.
- Power input: 90-264 VAC internal power supply
- Mounting configuration: panel with clips
- Touchscreens: resistive
- Operating temperature: -10° to 60° C
- Relative humidity: ≤ 90% to ≤ 95%
- Altitude: 10,000 ft MSL
- 2-year warranty



Monitor Features

- Front On Screen Display (OSD) controls

Configured with the Following	
Product:	DiamondVue / Gen 4
Mounting Style:	Clip Mount
Finish:	Black Powder Coated Aluminum
Display:	19" (5:4) 1280 x 1024(XGA) 350 Nits
Glass / Touchscreen:	Resistive with USB Touch
Connector Type:	Standard Connectors
Power Input:	90-264 VAC
Input / Output:	HDMI, DVI, VGA, BNC / Touch /
Operating Temp:	-10°/+60°C (Fans)

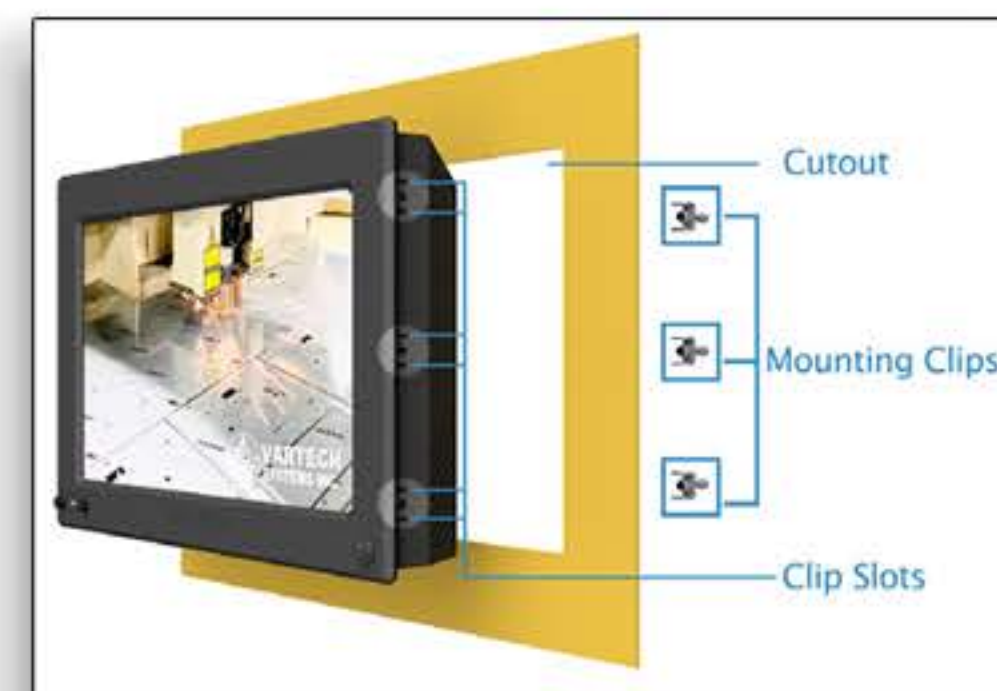

Specifications:

Size	Viewing Angle	Contrast	Power Consumption	Approx. Weight	Dimensions
19"	85°/85°/80°/80°	1000:1	≈ 20 W	≈ 15.25 Lbs	18.5" × 15.63" × 3.75"

I/O Connectors:



VGA



HDMI



DVI



NTSC/PAL



19.0" CLIP MOUNT (Monitor or Panel Computer)

PRELIMINARY DRAWING
DIMENSIONS ARE SUBJECT TO CHANGE

REVISION HISTORY			
REV	DATE	INITIALS	DESCRIPTION
00	11/27/19	MAW	INITIAL RELEASE

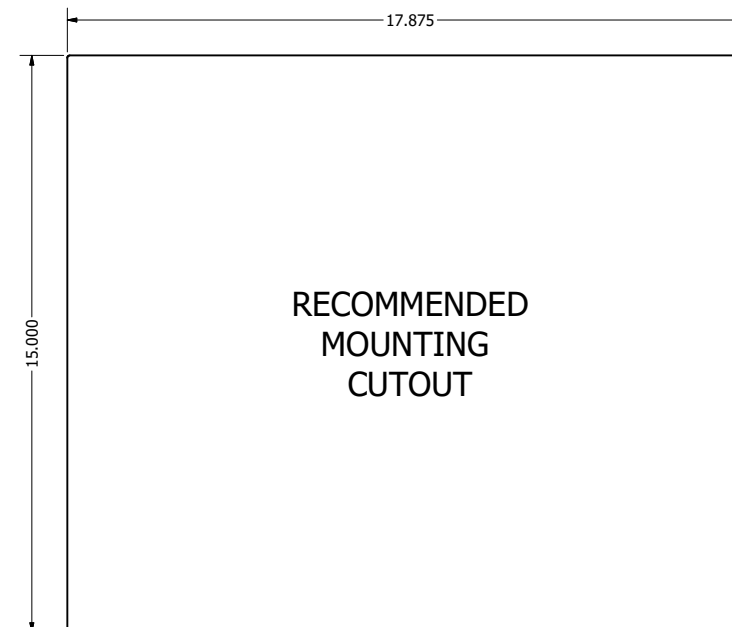
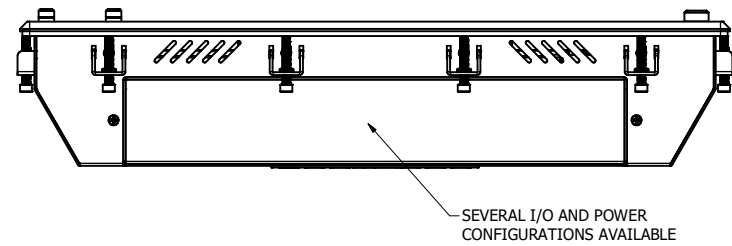
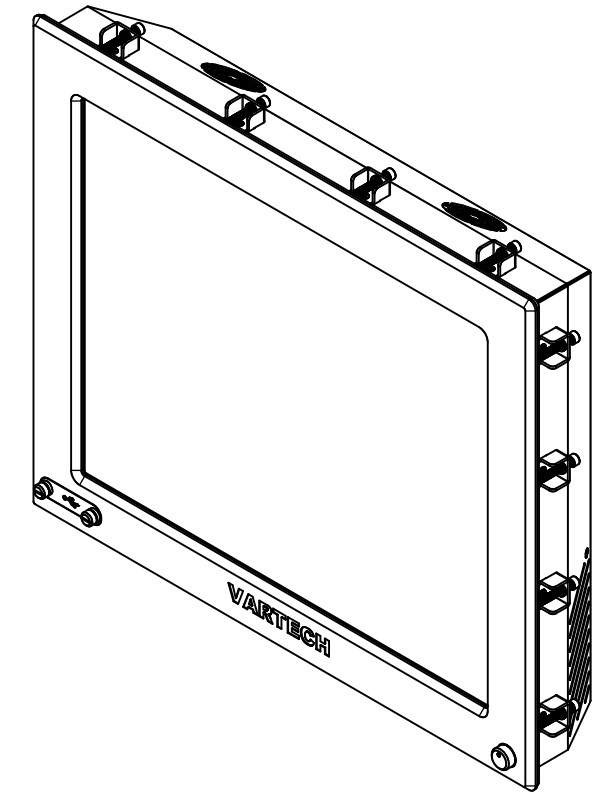
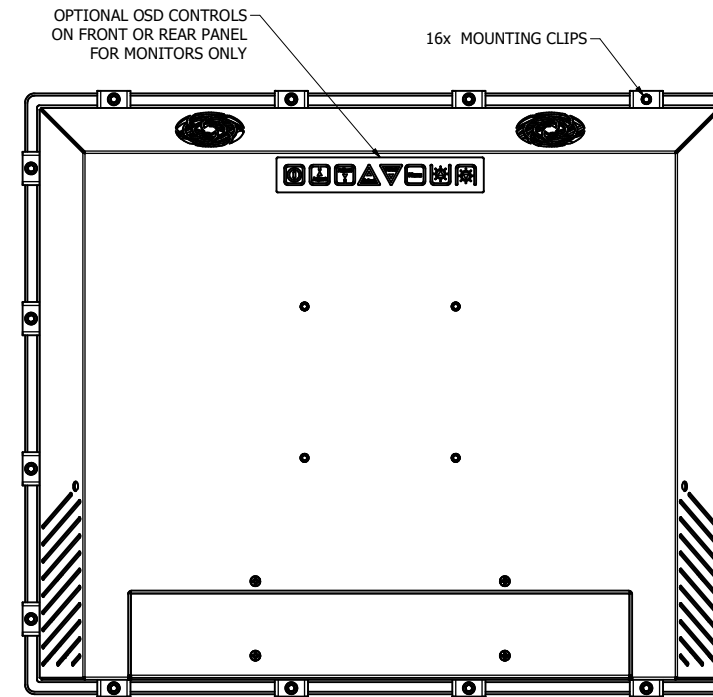
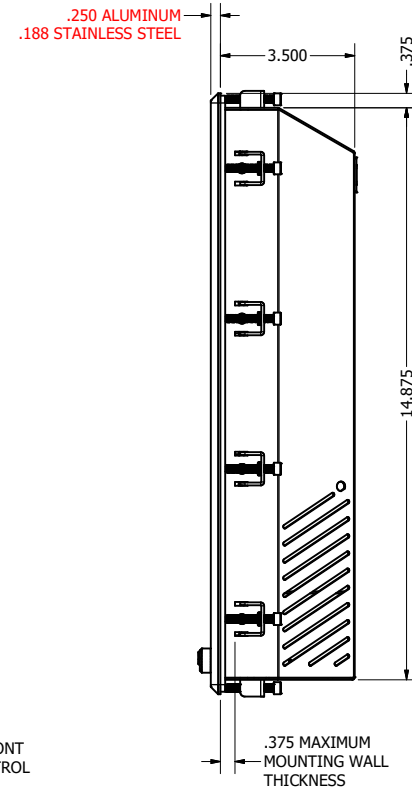
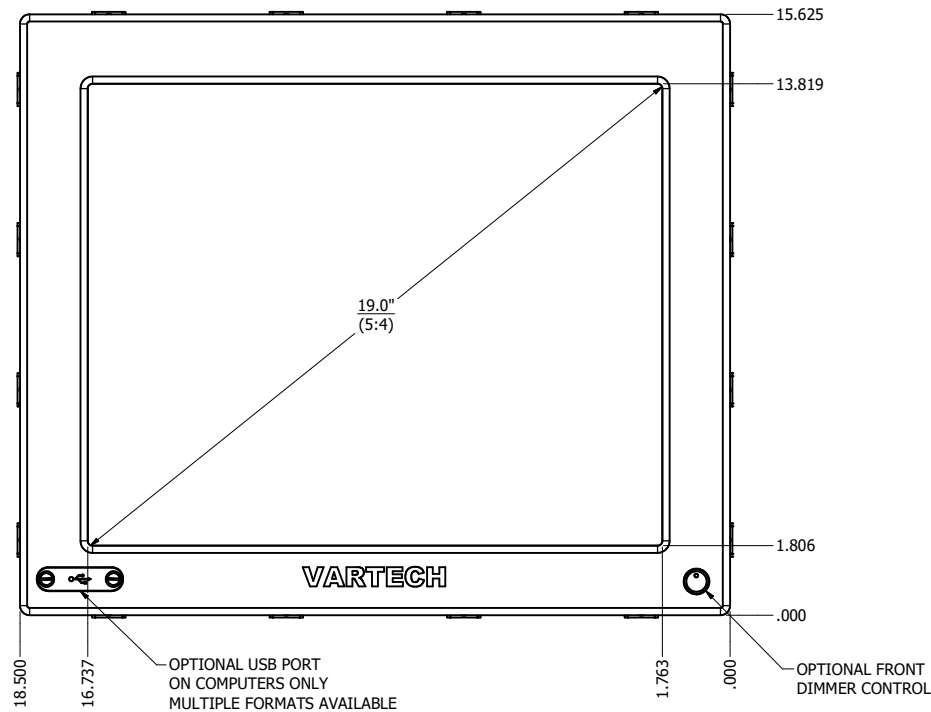
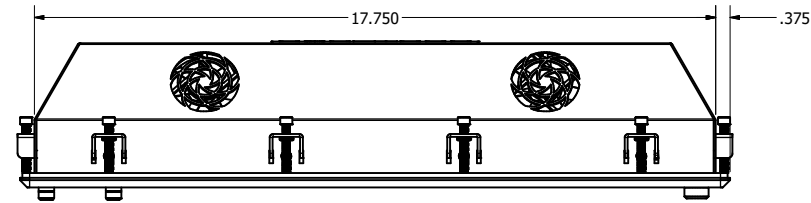

DRAWN BY: mwitham		11/26/2019			
USE WITH PRODUCT NUMBER					
MATERIAL & FINISH				TITLE	
				OUTLINE DRAWING DIAMONDVUE 4	
SHEET	SIZE	PART NUMBER	REV		
6 of 7	D	VTDV4#190dCP#	00		
TOLERANCES: .XX=.01 .XXX=.005					