

15A, 200V Schottky Barrier Surface Mount Rectifier

FEATURES

- AEC-Q101 qualified
- Low power loss, high efficiency
- Ideal for automated placement
- High surge current capability
- Moisture sensitivity level: level 1, per J-STD-020
- RoHS Compliant
- Halogen-free

APPLICATIONS

- Low voltage, high frequency, inverter
- DC/DC converter
- Freewheeling diodes
- Reverse battery protection
- Car lighting

MECHANICAL DATA

- Case: ThinDPAK
- Molding compound meets UL 94V-0 flammability rating
- Terminal: Matte tin plated leads, solderable per J-STD-002
- Meet JESD 201 class 2 whisker test
- Polarity: As marked
- Weight: 0.196g (approximately)

KEY PARAMETERS		
PARAMETER	VALUE	UNIT
I_F	15	A
V_{RRM}	200	V
I_{FSM}	150	A
T_{JMAX}	150	°C
Package	ThinDPAK	
Configuration	Common cathode	

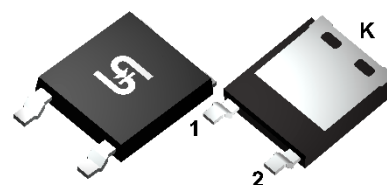

ThinDPAK

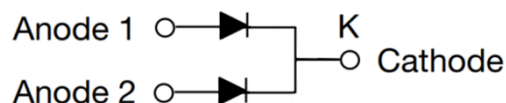

ABSOLUTE MAXIMUM RATINGS ($T_A = 25^\circ\text{C}$ unless otherwise noted)

PARAMETER	SYMBOL	MBRAD15200DH	UNIT
Marking code on the device		15200D	
Repetitive peak reverse voltage	V_{RRM}	200	V
Reverse voltage, total rms value	$V_{R(RMS)}$	140	V
Forward current per device	I_F	15	A
Surge peak forward current single half sine wave superimposed on rated load per diode	$t = 8.3\text{ms}$	150	A
	$t = 1.0\text{ms}$	380	A
Junction temperature	T_J	-55 to +150	°C
Storage temperature	T_{STG}	-55 to +150	°C

THERMAL PERFORMANCE			
PARAMETER	SYMBOL	TYP	UNIT
Junction-to-lead thermal resistance ⁽¹⁾	$R_{\theta JL}$	1.8	°C/W
Junction-to-ambient thermal resistance ⁽²⁾	$R_{\theta JA}$	12.1	°C/W
Junction-to-case thermal resistance ⁽²⁾	$R_{\theta JC}$	2.5	°C/W

Notes:

1. With ideal heat sink
2. Units mounted on 2" x 3" x 0.25" Al-plate

ELECTRICAL SPECIFICATIONS ($T_A = 25^\circ\text{C}$ unless otherwise noted)					
PARAMETER	CONDITIONS	SYMBOL	TYP	MAX	UNIT
Forward voltage per diode ⁽¹⁾	$I_F = 3.75\text{A}, T_J = 25^\circ\text{C}$	V_F	0.79	-	V
	$I_F = 7.50\text{A}, T_J = 25^\circ\text{C}$		0.87	0.95	V
	$I_F = 3.75\text{A}, T_J = 125^\circ\text{C}$		0.64	-	V
	$I_F = 7.50\text{A}, T_J = 125^\circ\text{C}$		0.73	0.80	V
Reverse current @ rated V_R per diode ⁽²⁾	$T_J = 25^\circ\text{C}$	I_R	-	10	μA
	$T_J = 125^\circ\text{C}$		-	2	mA
Junction capacitance per diode	1MHz, $V_R = 4.0\text{V}$	C_J	125	-	pF

Notes:

1. Pulse test with $PW = 0.3\text{ms}$
2. Pulse test with $PW = 30\text{ms}$

ORDERING INFORMATION		
ORDERING CODE	PACKAGE	PACKING
MBRAD15200DH	ThinDPAK	4,500 / Tape & Reel

CHARACTERISTICS CURVES

($T_A = 25^\circ\text{C}$ unless otherwise noted)

Fig.1 Forward Current Derating Curve

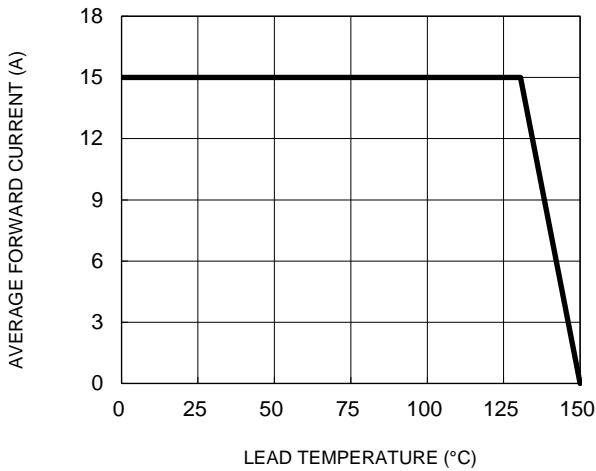

Fig.2 Typical Junction Capacitance

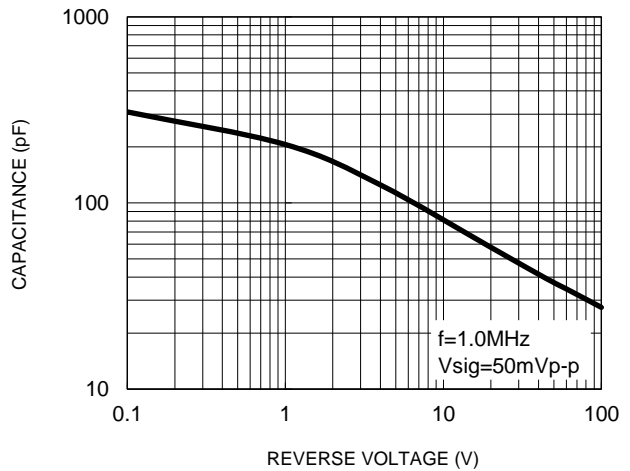

Fig.3 Typical Reverse Characteristics

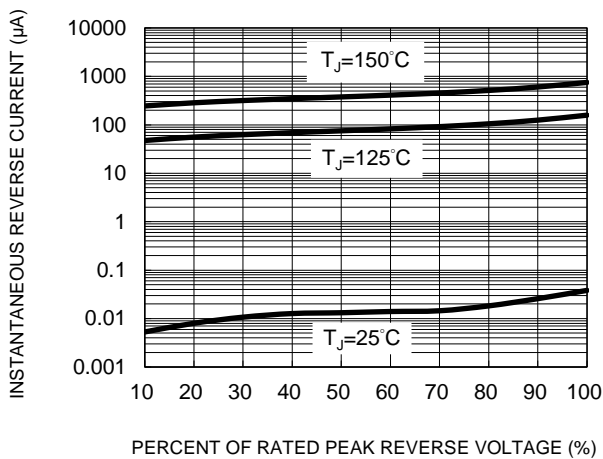

Fig.4 Typical Forward Characteristics

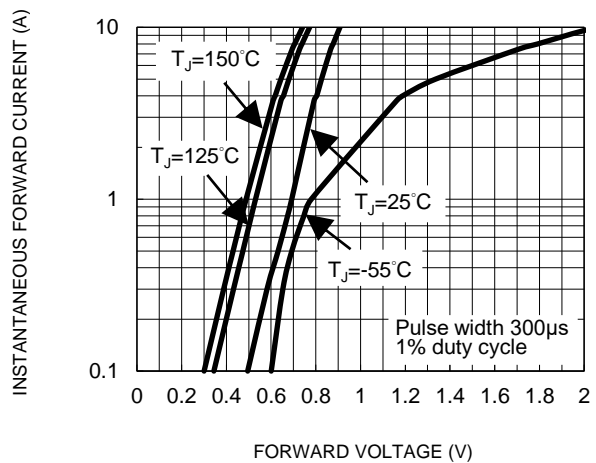
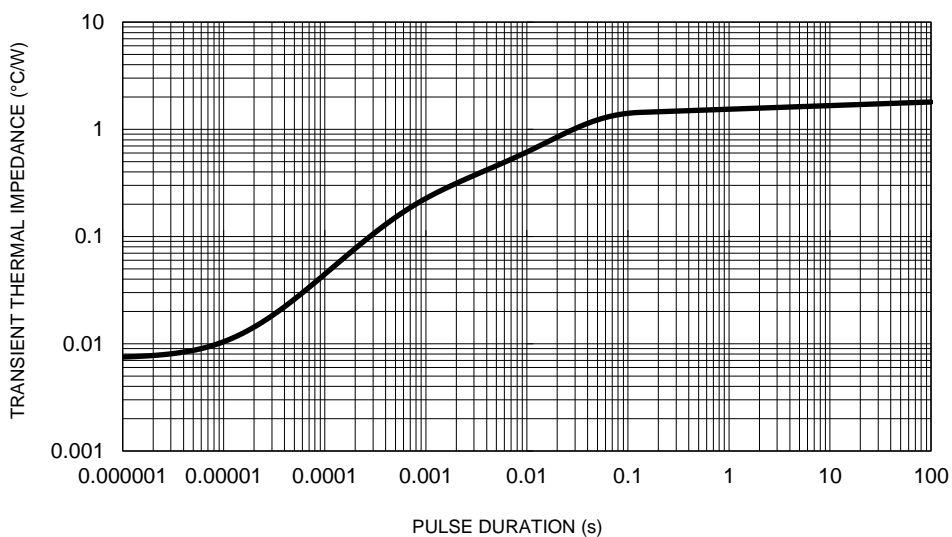
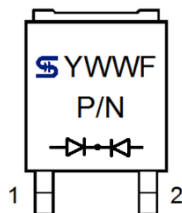
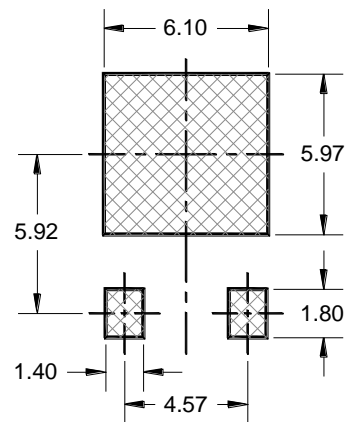
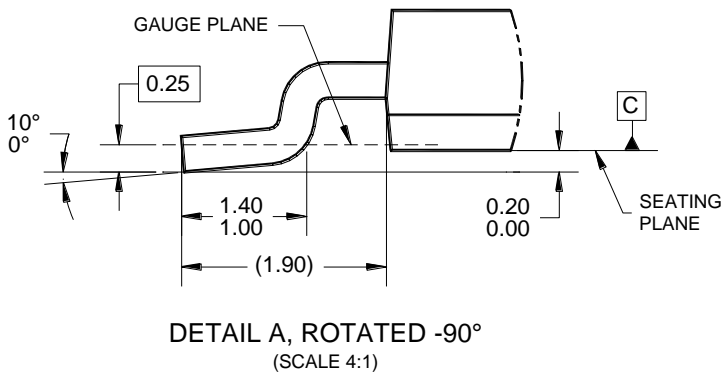
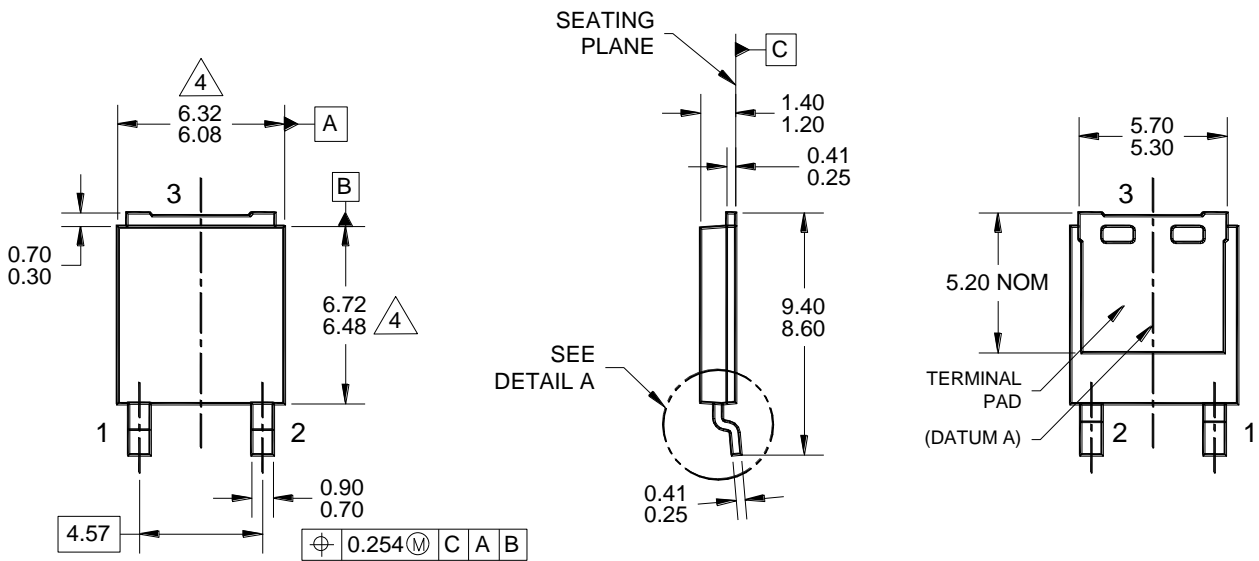

Fig.5 Typical Transient Thermal Impedance



PACKAGE OUTLINE DIMENSIONS

ThinDPAK



MARKING DIAGRAM

YWW = DATE CODE
F = FACTORY CODE
P/N = MARKING CODE

SUGGESTED PAD LAYOUT

NOTES: UNLESS OTHERWISE SPECIFIED

1. ALL DIMENSIONS ARE IN MILLIMETERS.
2. DIMENSIONING AND TOLERANCING PER ASME Y14.5M-1994.
3. PACKAGE OUTLINE REFERENCE: JEDEC TO-252, VARIATION AE, ISSUE F.
4. MOLDED PLASTIC BODY DIMENSIONS DO NOT INCLUDE MOLD FLASH, PROTRUSION, OR GATE BURRS.
5. DWG NO. REF: HQ2SD07-TDPAK-065 REV A.

Notice

Specifications of the products displayed herein are subject to change without notice. TSC or anyone on its behalf assumes no responsibility or liability for any errors or inaccuracies.

Purchasers are solely responsible for the choice, selection, and use of TSC products and TSC assumes no liability for application assistance or the design of Purchasers' products.

Information contained herein is intended to provide a product description only. No license, express or implied, to any intellectual property rights is granted by this document. Except as provided in TSC's terms and conditions of sale for such products, TSC assumes no liability whatsoever, and disclaims any express or implied warranty, relating to sale and/or use of TSC products including liability or warranties relating to fitness for a particular purpose, merchantability, or infringement of any patent, copyright, or other intellectual property right.

The products shown herein are not designed for use in medical, lifesaving, or life-sustaining applications. Customers using or selling these products for use in such applications do so at their own risk and agree to fully indemnify TSC for any damages resulting from such improper use or sale.