

Suitable for Installation Virtually Anywhere

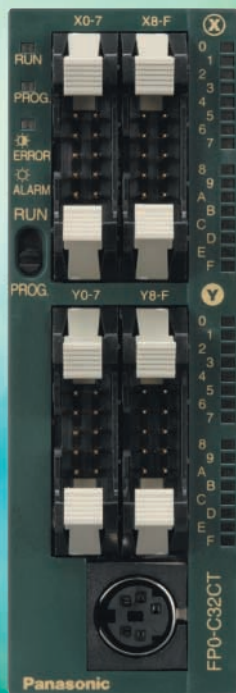

Actual size:
W30 × H90 × D60 (mm)
W1.181 × H3.543 × D2.362 (inch)



I/O 10 points/14 points
(Relay output,
terminal block type)



I/O 16 points
(Transistor
output type)



I/O 32 points
(Transistor
output type)

Excellent space-saving design!

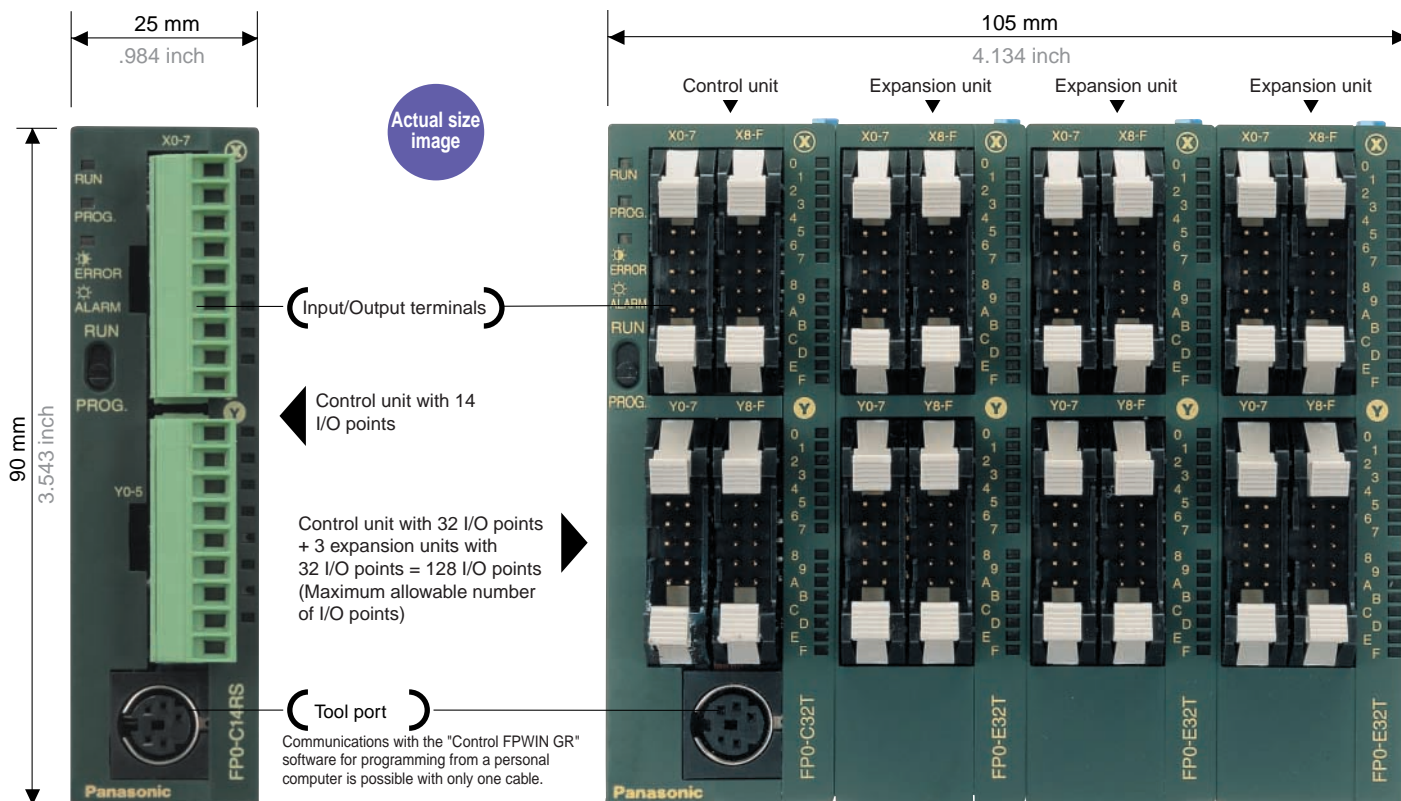

From **10**
I/O points

Up to **128**
I/O points

The control unit width is only 25 mm .984 inch*. Only 105 mm 4.134 inch even in combination with expansion units having a maximum of 128 I/O points

Up to three expansion units can be directly connected without connection cables.

* The width of the control unit with 32 I/O points and the S-LINK control unit is 30 mm 1.181 inch.

The control unit can fit in your pocket: W 25 × H 90 × D 60 mm W .984 × H 3.543 × D 2.362 inch

The number of I/O points can be expanded up to 128. Even with the maximum expansion, the size is only W 105 × H 90 × D 60 mm W 4.134 × H 3.543 × D 2.362 inch. The ultra-compact body size and installation area beyond comparison with the conventional compact PLCs facilitate the miniaturization of target machines, equipment, and control panels.

● Three selectable installation methods



DIN rail



Slim type mounting plate



Flat type mounting plate*
* Cannot be used for

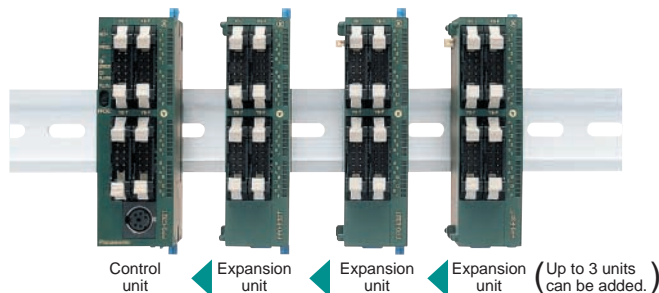

A terminal block type and a connector type are available. Both can be detached for easy wiring.

● Terminal block



Terminal block type (European type, made by Phoenix Contact): Installation of electric wires having a cross section of 0.2 to 1.25 mm² is possible without crimp terminals.

Available for:
FP0-C10RS, C10CRS,
C14RS, C14CRS, E8RS,
E8YRS, E16RS

● Connector

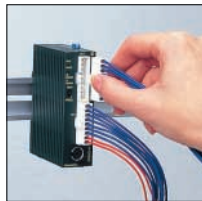

Connector type (made by Molex): Ideal for installation during mass production. Installation of electric wires having a cross section of 0.2 to 0.75 mm² is available

Available for:
FP0-C10RM, C10CRM,
C14RM, C14CRM, E8RM,
E16RM

● MIL connector



Wire-press sockets are attached to the units with 16 or 32 I/O points. Installation of electric wires having a cross section of 0.2 to 0.3 mm² is possible without stripping the wire cover.

Available for:
FP0-C16T, C16CT, C32T,
C32CT, T32CT, E8X, E8YT,
E16X, E16YT, E16T, E32T

EEPROM is used as the program memory. Program rewriting is possible even when running!

● Rewriting in RUN mode

Programs can be rewritten for debugging or activation adjustments during the operation of FP0.

● No backup battery required

EEPROM is used as the program memory. Programs and device data can be stored without backup batteries, ensuring safe use in mass-produced machines.

● Password protection

Program rewriting can be password-protected. Program rewriters can be limited, enhancing maintenance reliability.

High-speed operation of 0.9 μs per basic instruction meets the need for a quick response.

● High-speed operation

Each basic instruction can be operated in 0.9 μs. A 500-step program can be scanned in approx. 1 ms. The highest processing speed in this class of controller has been achieved.

● Pulse catch function

Can read pulses as short as 50 μs. Ideal for sensor input.

● Interrupt input function

Reliable processing is available without being affected by the scan time.

Wide variety of intelligent units

● Analog unit



Analog I/O, A/D conversion, and D/A conversion units are available. Up to three units can be connected, allowing multi-channel analog control.

Available for:
FP0-A21, FP0-A80, FP0-A04V, FP0-A04I

● Thermocouple unit

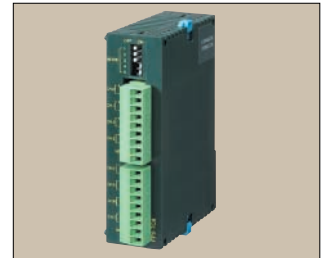

Total accuracy: ± 0.8 °C (K/J/T range). Two types are available: 4-ch/8-ch types. Up to three units can be connected, allowing high-accuracy multi-point temperature control of a maximum of 24 channels.

Available for:
FP0-TC4, FP0-TC8

● CC-Link slave unit



Supports CC-Link, which is an open network. Reading/Writing of four-word data through a maximum of 16 input and 16 output points.

Available for:
FP0-CCLS

● I/O link unit



A link unit to enable FP0 to serve as a slave station of MEWNET-F (remote I/O system).

Available for:
FP0-IOL

● S-LINK control unit



Can be directly connected to the S-LINK wire-saving system and control up to 64 input and 64 output points.

* S-LINK is a trademark of SUNX Limited.

Available for:
FP0-SL1

● Power supply unit



A power supply unit having the same height and depth as that of FP0. Input: 100 to 240 V AC universal. Output: 24 V AC up to 0.7 A

Available for:
FP0-PSA4

FP0 Features

Equipped with 2-axis independent positioning, high-speed counter and PWM output

● Pulse output function (For transistor output type only)

The FP0 comes equipped with 2 channels of pulse output up to 10 kHz (5 kHz during 2-channel output). Since these two channels can be separately controlled, the FP0 is also suitable for 2-axis independent positioning. Setting for automatic trapezoid control, automatic return to home position and JOG operation are very easy, by using special instructions.

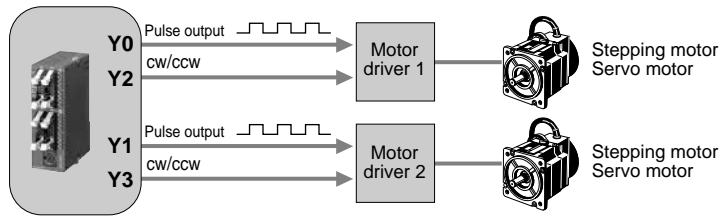

● High-speed counter function

The high-speed counter is prepared for 4 channels in single phase, and 2 channels in 2-phase. In single phase, the 4-channel total is 10 kHz, and in 2-phase the 2-channel total is 2 kHz total speed, making the unit suitable for inverter control, and so forth.

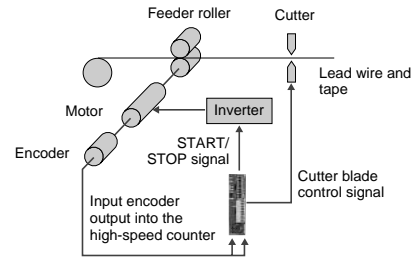

Position control is a breeze with the auto trapezoid control instruction F168!

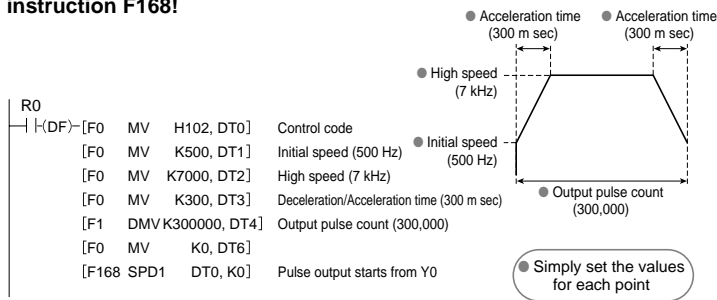

● PWM output function

(For transistor output type only)

Its PWM output (Pulse Width Modulation output) function makes it possible to provide temperature control with a single compact FP0 unit.

● When pulse width values are increased...



● When reduced...



RS232C port enables serial communications. (Product No. C10CR, C14CR, C16CT, C32CT, T32CT, SL1)

The RS232C port allows the direct connection to computers and operation display panels. Also, bi-directional data communication with bar-code readers and other RS232C devices is made easy.

* The port block is connected by three S.R.G. terminals. Operation display panels can also be connected using the tool port.
 * RS232C port is equipped on the control units for both relay types and transistor output types.

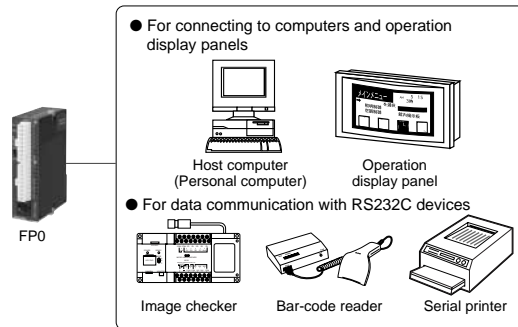

Wide variety of analog units available

Even with compact body, the following analog units are available.

- FP0-A21 (AFP0480) : 2 input, 1 output
- FP0-A80 (AFP0401) : 8 input
- FP0-A04V (AFP04121) : Voltage 4 output
- FP0-A04I (AFP04123) : Current 4 output
- FP0-TC4 (AFP0420) : Thermocouple 4 input
- FP0-TC8 (AFP0421) : Thermocouple 8 input

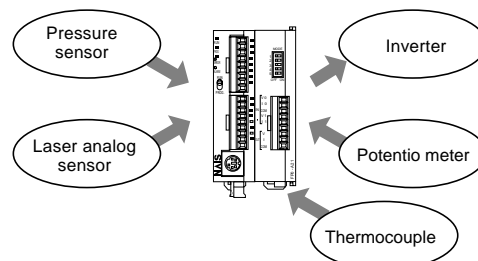

Can be directly connected to the S-LINK wire-saving system (SUNX Ltd.).

The FP0 S-Link control unit makes sensor wiring and control panel simple by using easy T-shape connectability and 4-wire cable. It can control up to 128 input/output of S-Link I/O devices. Adding up to three FP0 Expansion units you can have flexible I/O configuration capability.

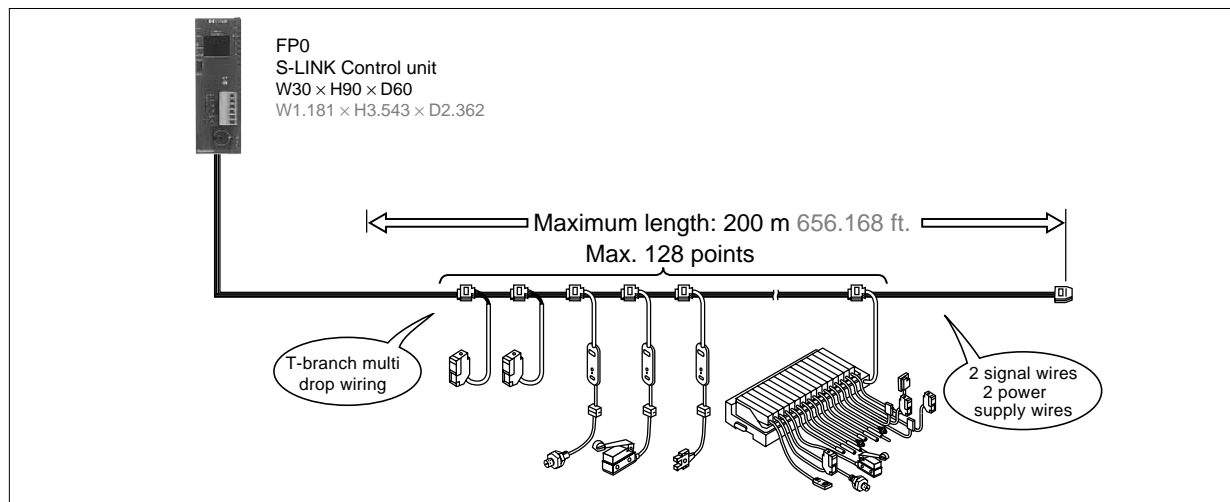

Surveillance possible of FP0 operation status from a Web browser using FP Web-Server Unit

Connecting an FP0 to the FP Web-Server unit with an RS232C cable and then setting up using the dedicated software (FP Web Configurator Tool) makes surveillance possible of the FP0 running conditions from a PC Web browser.

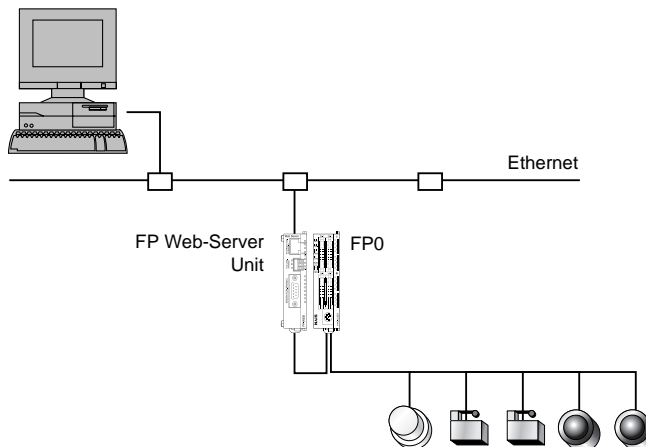

By using C-NET, you can use multiple FP0s as data collection terminals.

By using the C-NET network and exclusive adapters, you can connect multiple FP0s by multi-drop connection with 2-wire cables. You can use computers for distributed control or have network terminals for a centralized management system.

● PCWAY

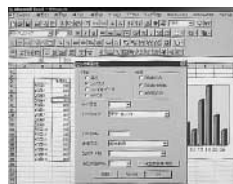

The Excel add-in software iPCWAYi is available for data collection of the networked PLCs. PLC status and data registers value can be simply shown and managed on Excel worksheets, which also makes it possible to transmit Email when malfunctions occur or to make status inquiries.

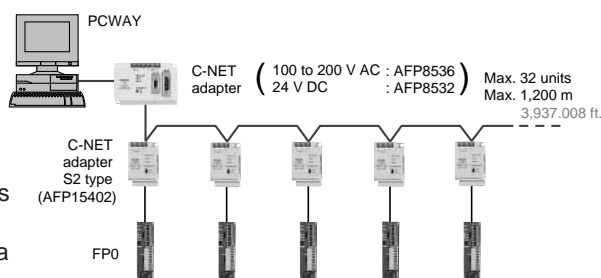

FP0 Unit list

■ Control units

- Units having 10 to 32 I/O points are available depending on the output type.
- A model having an RS232C port has been added to each type.
- A type that can be directly connected to the S-LINK wire-saving system (SUNX Ltd.) is also available.
- A 10-k step type with a calendar timer function and an RS232C port is also available.

● Precautions for selection

PNP transistor output type is also available.

Replace "4" in the second last digit of Product No. with "5" to order the PNP output type.

The price is the same.

E.g.: AFP02543 → AFP02553

The last character of the product number for the NPN output type is "T", and that for the PNP output type is "P".

NPN output type: FP0-C16T
→ PNP output type: FP0-C16P

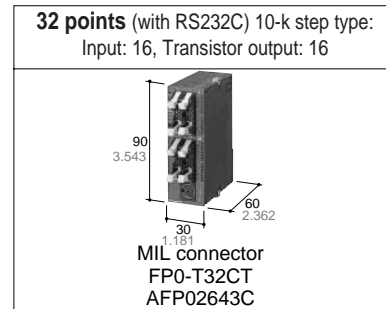
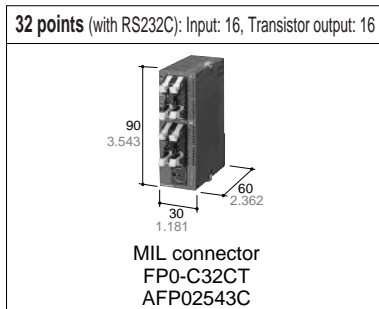
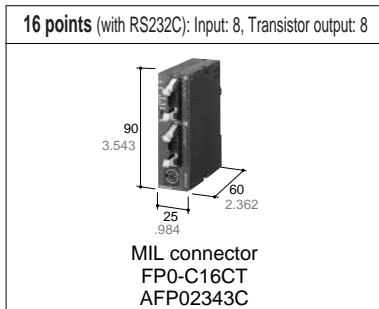
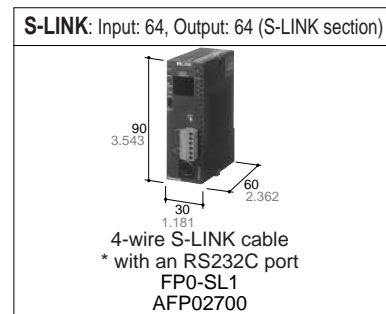
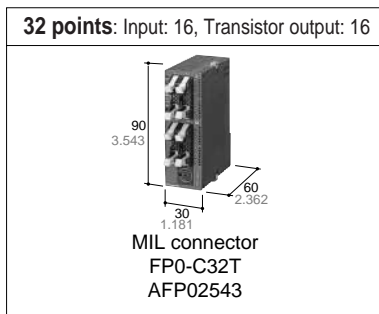
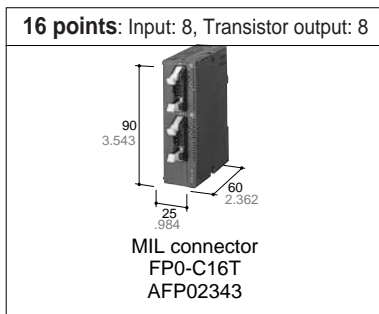
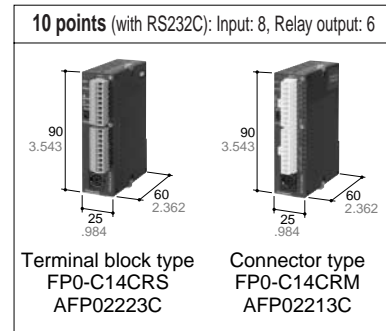
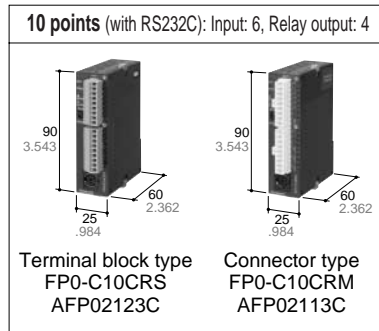
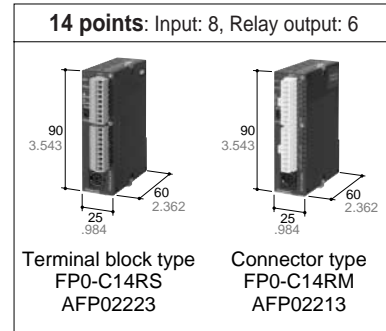
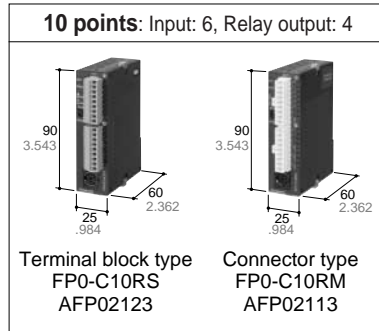

■ Expansion units

- The input-only and output-only types added to the lineup enhance the flexibility of I/O expansion.

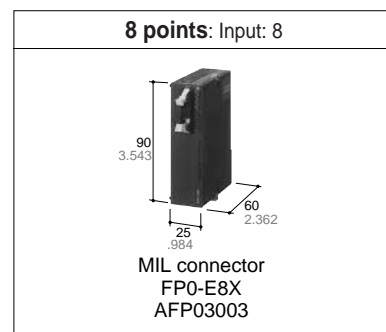
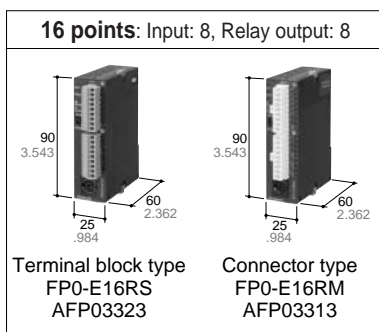
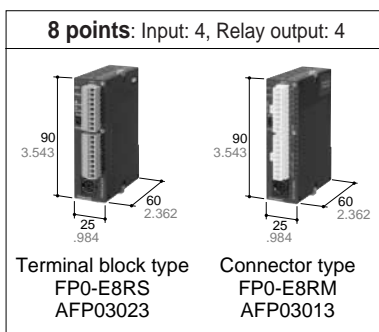

16 points: Input: 16

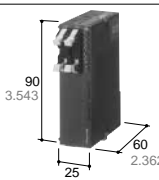

MIL connector
FP0-E16X
AFP03303

16 points: Input: 8, Transistor output: 8

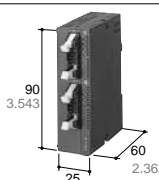

MIL connector
FP0-E16T
AFP03343

32 points: Input: 16, Transistor output: 16

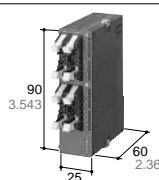

MIL connector
FP0-E32T
AFP03543

8 points: Relay output: 8

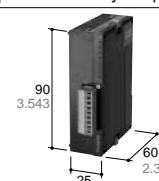

Terminal block
FP0-E8YRS
AFP03020

8 points: Transistor output: 8

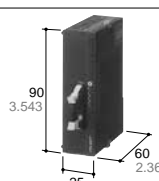

MIL connector
FP0-E8YT
AFP03040

16 points: Transistor output: 16

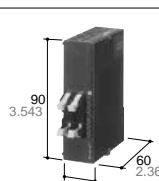

MIL connector
FP0-E16YT
AFP03340

■ Intelligent units

- Addition of the analog I/O unit to the lineup enabled analog control by FP0.

Analog I/O unit
Input: 2 ch, Output: 1 ch

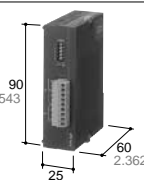

Terminal block
FP0-A21
AFP0480

A/D converter unit
Input: 8 ch

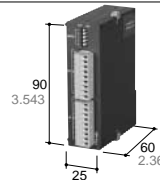

Terminal block
FP0-A80
AFP0401

D/A converter unit
Voltage output: 4 ch

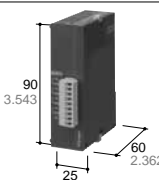

Terminal block
FP0-A04V
AFP04121

D/A converter unit
Current output: 4 ch

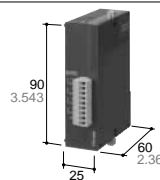

Terminal block
FP0-A04I
AFP04123

Thermocouple unit

4ch FP0-TC4 AFP0420
8ch FP0-TC8 AFP0421

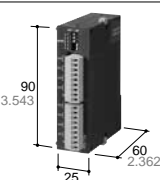

■ Link/communication units

FP0 CC-Link slave unit

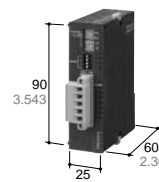

FP0-CCLS
AFP07943

I/O link unit

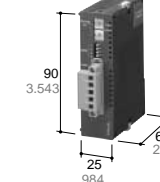

I/O link unit
FP0-IOL
AFP0732

C-NET adapter S2 type



Adapter to link with a host computer
With a 30-cm 1.181-inch dedicated cable.
No power supply required.
AFP15402

FP Web-Server unit

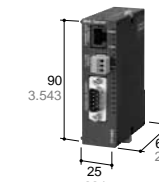

FP-Web
AFP0610

■ Power supply unit and others

Power supply Input: 100 to 240 V AC,
Output: 24 V DC, 0.7 A

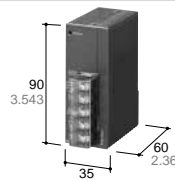

FP0-PSA4
AFP0634

FP memory loader



Data clear type/Data hold type
AFP8670/AFP8671

■ Expansion method

- Additional cables are not necessary for expansion because the units can be directly connected to one another using the expansion connector and lock lever on the unit side.

● Transistor output type combinations

$$\left(\begin{array}{c} \text{Total number of} \\ \text{I/O points} \end{array} \right) = \left(\text{Control unit} \right) + \left(\begin{array}{c} \text{Expansion unit 1} \\ \text{X20 - / Y20 -} \end{array} \right) + \left(\begin{array}{c} \text{Expansion unit 2} \\ \text{X40 - / Y40 -} \end{array} \right) + \left(\begin{array}{c} \text{Expansion unit 3} \\ \text{X60 - / Y60 -} \end{array} \right)$$

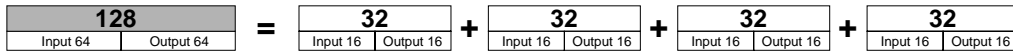
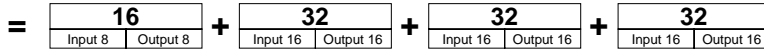
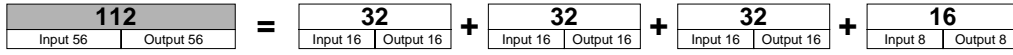
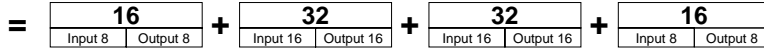
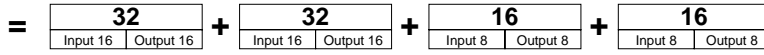
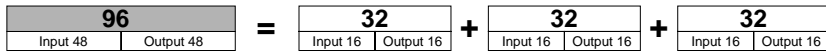
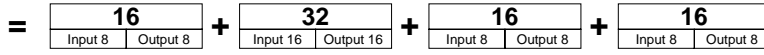
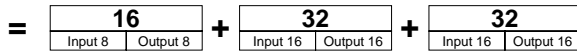
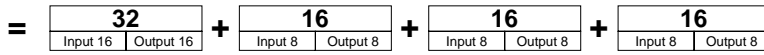
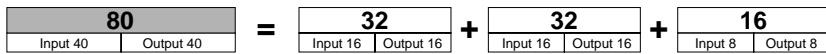
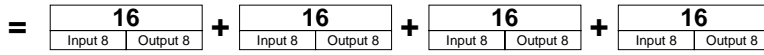
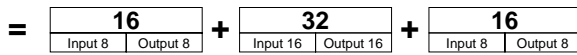
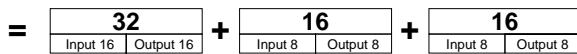
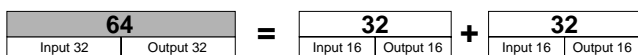
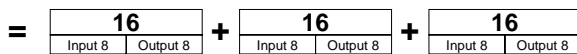
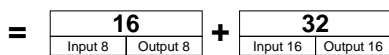
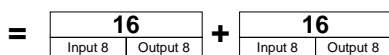
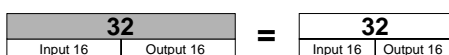
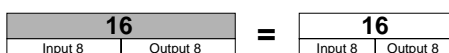

FP0 Specifications

■ Performance specifications

Model		C10 series (Relay output type only)	C14 series (Relay output type only)	C16 series (Transistor output type only)	C32 series (Transistor output type only)	S-LINK type	T32 series (Transistor output type only)	
Programming method / Control method		Relay symbol / Cyclic operation						
Number of I/O points	No expansion (control unit only)	10 points [Input: 6, NPN Output: 4]	14 points [Input: 8, NPN Output: 6]	16 points [Input: 8, NPN Output: 8]	32 points [Input: 16, NPN Output: 16]	S-LINK section: max. 128 points [Input: 64, NPN Output: 64]	32 points [Input: 16, NPN Output: 16]	
	W/expansion 1 * Same type of control and expansion units	Max. 58 points	Max. 62 points	Max. 112 points	Max. 128 points	Expansion section: Max. 96 points	Max. 128 points	
	W/expansion 2 * Mix type of relay and transistor units	Max. 106 points	Max. 110 points	Max. 112 points	Max. 128 points		Max. 128 points	
Program memory		EEP-ROM (no back up battery required)						
Program capacity		2.7 k steps			5 k steps		10 k steps	
Number of instructions	Basic	83						
	High-level	115						
Operation speed (central value/step)		0.9 μs/step (for basic instructions)						
Operation memory points	Relay	Internal relay (R)		1,008 points				
		Timer/Counter (T/C)		114 points				
	Memory area	Data register (DT)		1,660 words		6,144 words		16,384 words
Index register (IX,IY)		2 words						
Master control relay points (MCR)		32 points						
Number of labels (JMP and LOOP)		64 labels					255 labels	
Differential points		Unlimited number of points						
Number of step ladder		128 stages					704 stages	
Number of subroutines		16 subroutines					100 subroutines	
Special functions	High speed counter	1 phase/4 points (10 kHz in total) or 2 phases/2 points (2 kHz in total)*			—		Available (same as 32 points series)	
	Pulse output	—		2 points (10 kHz* in total), enable to control 2 channels individually*		—		
	PWM output	—		0.15 Hz to 1 kHz		—		
	Pulse catch input/interrupt input	6 points (with high speed counter)					—	
	Interrupt program	7 programs (external 6 points, internal 1 point)					1 program (internal 1 point)	
	Periodical interrupt	0.5 ms to 30 s						
	Constant scan	Available						
RS232C port		One RS232C port is mounted on each of the models FP0- C10CR, C14CR, C16CT, C16CP, C32CT, C32CP, T32CT, T32CP and SL1 type (3P terminal block) Transmission speed (Baud rate): 300 to 19,200 bits/s, Transmission distance: 3 m 9.843 ft Communication method: half duplex						
Maintenance	Memory back up	Program and system register	Stored program and system register in EEPROM					
		Operation memory	Stored fixed area in EEPROM Counter: 4 points Internal relay: 32 points Data register: 8 words		Stored fixed area in EEPROM Counter: 16 points Internal relay: 128 points Data register: 32 words		Backup is provided by secondary battery. The holding range for the timers, counters internal relays, and data registers are specified with the programming tool.	
	Self-diagnostic function		Watchdog timer, program syntax check					
	Clock/Calendar function		—					
	Other functions		Runtime editing, password setting					

* For the limitations while operating units, see the manual.

■ General specifications

Item	Description
Rated voltage	24 V DC
Operating voltage range	21.6 to 26.4 V DC
Allowed momentary power off time	10 points, 14 points type
	16 points, 32 points, S-LINK type
Ambient temperature	0 to +55 °C 32 to +131 °F
Storage temperature	-20 to +70 °C -4 to +158 °F
Ambient humidity	30 to 85% RH (non-condensing)
Storage humidity	30 to 85% RH (non-condensing)
Breakdown voltage	Between input/output terminals and power/ground terminals: 500 V AC for 1 minute (for the relay output type, 1500 V AC for 1 minute) Between input terminals and output terminals: 500 V AC for 1 minute (for the relay output type, 1500 V AC for 1 minute)
Insulation resistance	Between input/output terminals and power/ground terminals: Over 100 MΩ (using a 500V DC megger) Between input terminals and output terminals: Over 100 MΩ (using a 500V DC megger)
Vibration resistance	10 to 55 Hz, 1 sweep/min. Double amplitude of 0.75 mm .030 inch, 10 min. on 3 axes
Shock resistance	98 m/s ² or more , 4 times on 3 axes
Noise immunity	1,000 V (p-p) with pulse widths 50 ns and 1 μs (using a noise simulator)
Operating condition	Free from corrosive gasses and excessive dust

■ Input specification (As for the limitation on the number of simultaneous ON points, please refer to the manual.)

Item	Description
Rated input voltage	24 V DC
Operating voltage range	21.6 to 26.4 V DC
Rated input current	Approx. 4.3 mA (at 24 V DC)
Input impedance	Approx. 5.6 kΩ
Input points per common	±common, 4 points/common (E8RS/E8RM), 6 points/common (C10RS/C10RM), 8 points/common (C14RS/C14RM, C16T, E16T, E16R, E8X), 16 points/common (C32T/E32T/E16X)
Min. ON voltage/ON current	19.2 V / 3 mA
Max. OFF voltage/OFF current	2.4 V / 1 mA
Response time	50 μs or less (at X0, X1) ^{Note 1)} (at 24V DC and under the ambient temperature of 25 °C 77 °F)
	100 μs or less (at X2 to X5) ^{Note 1)} (at 24 V DC and under the ambient temperature of 25 °C 77 °F)
	2 ms or less (at X6 onward)
ON → OFF	Same as above
Insulation method	Photocoupler

Note 1) Since the response time of X0 to X5 is very fast (for high-speed counter input) the FP0 happens to chattering noise as an input signal. To prevent this, it is recommended that the timer should be put in the ladder program.

■ Output specification

1. Relay output type

Item	Description
Output type	1a (1 form A, normally open)
Rated control capacity	2 A 250 V AC, 2 A 30 V DC (4.5 A/common)
Response time	OFF → ON
	ON → OFF
Life time	Mechanical
	Electrical
Surge absorber	None
Operating indicator	LED display

2. Transistor output type

Item	Description
Output type	Open collector
Rated load voltage	NPN type: 5 to 24 V DC, PNP type: 24 V DC
Load voltage allowable range	NPN type: 4.75 to 26.4 V DC PNP type: 21.6 to 26.4 V DC
Max. load current	0.1 A/point (1 A/common)
Max. inrush current	0.3 A
OFF state leakage current	100 μA or less
ON state voltage drop	1.5 V or less
Response time	OFF → ON
	ON → OFF
Voltage range for external power supply	21.6 to 26.4 V DC
Surge absorber	Zener diode
Output points per common	8 points/common (C16T, C16P, C16CT, C16CP, E16T, E16P, E8YT, E8YP)
	16 points/common (C32T, C32P, C32CT, C32CP, E32T, E32P, E16YT, E16YP)
Insulation method	Photocoupler

■ I/O circuit diagram

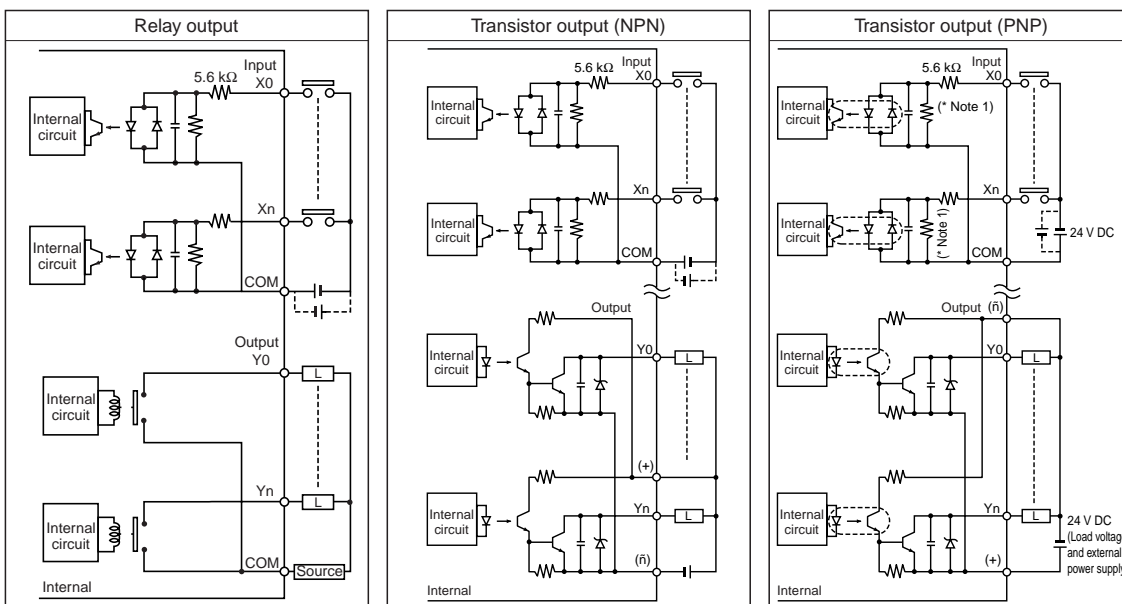

Note: For transistor output types, make sure that the externally supplied voltage between the (+) and (-) terminal is between 21.6 and 26.4 V DC.

■ Analog unit specifications

1. Analog input specifications

Item	Description	
	FP0-A21	FP0-A80
Number of input points	2 channels/unit	8 channels/unit (Number of input points can be changed 2, 4, 6 and 8 channels.)
Input range	Voltage range	0 to 5 V (K 0 to K 4000) Note 1) -10 to +10 V (K -2000 to K +2000) Note 1)
	Current range	0 to 20 mA (K 0 to K 4000) Note 1)
Resolution	1/4000 (12 bits)	
Conversion speed	1 ms/channel Note 2)	
Overall precision	±1% F.S. or less (0 to 55 °C), ±0.6% F.S. or less (25 °C)	
Input impedance	Voltage range	1 MΩ or more
	Current range	250 Ω
Absolute maximum input	Voltage range	±15 V
	Current range	±30 mA
Insulation method	Between analog input terminal and FP0 internal circuit: optical coupler insulation (non-insulated between channels) Between analog input terminal and I/O unit external power supply: based on insulation-type DC/DC converter Between analog input terminal and analog output terminal: based on insulation-type DC/DC converter	Between analog output terminal and FP0 internal circuit: optical coupler insulation (non-insulated between channels) Between analog output terminal and D/A converter unit external power supply: based on insulation-type DC/DC converter
Number of I/O contact points	32 input contact points	
Averaging function	None	
	Can be switched on and off.	

Notes

- 1) If the analog input value exceeds the upper or lower limit, the digital value will preserve the upper or lower limit.
- 2) The number for the input contact point being used varies depending on the expansion position.

FP0-A21

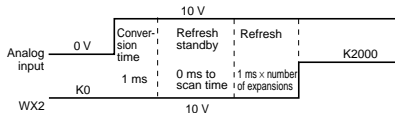

FP0-A80

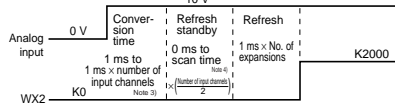

- 3) Settings value switch for the number of input channels.
- 4) With each one scan of the control unit, the data for two channels will be loaded into it. In other words, if the input channel number switch is set to 8-channel, the data in the control unit will be updated once every four scans.

2. Analog output specifications

Item	Description		
	FP0-A21	FP0-A04V	FP0-A04I
Number of output points	1 channel/unit	Voltage output: 4 channels/units	Current output: 4 channels/units
Output range	Voltage range	-10 to +10 V range (K -2000 to K +2000) Note 1)	—
	Current range	0 to 20 mA (K 0 to K 4000) Note 1)	4 to 20 mA (K 0 to K 4000) Note 1)
Resolution	1/4000 (12 bits)		
Conversion speed	500 μs/channel Note 2)		
Overall precision	±1% F.S. or less (0 to 55 °C), ±0.6% F.S. or less (25 °C)		
Output impedance	Voltage range	0.5 Ω or less	
	Current range	—	
Absolute output load resistance	Voltage range	±10 mA	
Max. output current	Voltage range	30 Ω or less	1000 Ω or less
	Current range	—	500 Ω or less
Insulation method note 2)	Between analog output terminal and FP0 internal circuit: optical coupler insulation (non-insulated between channels) Between analog output terminal and analog I/O unit external power supply: based on insulation-type DC/DC converter Between analog output terminal and analog input terminal: based on insulation-type DC/DC converter	Between analog output terminal and FP0 internal circuit: optical coupler insulation (non-insulated between channels) Between analog output terminal and D/A converter unit external power supply: based on insulation-type DC/DC converter	
Number of I/O contact points	16 output contact points	16 input contact points, 32 output contact points Note 3)	

Notes

- 1) If the digital input value exceeds the upper or lower limit, D/A conversion will not take place. (Analog output will remain as the previous data.)
- 2) The number for the output contact point being used varies depending on the expansion position.

FP0-A21

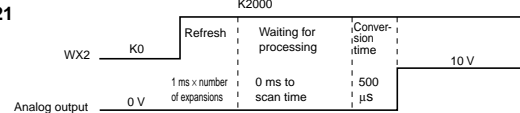

FP0-A04V, FP0-A04I

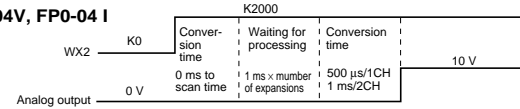

- 3) The data for two channels will be output to the D/A converter unit with one scan of the control unit.

■ Thermocouple unit specifications

Item	Description	
Input points	4-channel, 8-channel (The number of input points can be changed 2, 4, 6 and 8 channels.)	
Input range	Thermocouple types K and J -100.0 to 500.0 °C/-148.0 to 790.0 °F Note 1)	
	Thermocouple type T -100.0 to 400.0 °C/-148.0 to 752.0 °F	
	Thermocouple type R 0.0 to 1500.0 °C/32.0 to 1590.0 °F Note 1)	
	K and J (when using °C): K -1000 to K 5000 K and J (when using °F): K -1480 to K 7900 Note 1) (When range over using °C: K-1001, K 5001 or K 8000) (When range over using °F: K-1481, K 7901 or K 8000) (When the thermocouple broken: K 8000) Note 2) (Until the temperature can be measured at the initial startup: K 8001) Note 3)	
Digital output	T (when using °C): K -1000 to K 4000 T (when using °F): K -1480 to K 7520 Note 1) (When range over using °C: K -1001, K 4001 or K 8000) (When range over using °F: K -1481, K 7521 or K 8000) (When the thermocouple broken: K 8000) Note 2) (Until the temperature can be measured at the initial startup: K 8001) Note 3)	
	R (when using °C): K 0 to K 15000 R (when using °F): K 320 to K 15900 Note 1) (When range over using °C: K 0, K 15001 or K 16000) (When range over using °F: K 0, K 15901 or K 16000) (When the thermocouple broken: K 16000) Note 2) (Until the temperature can be measured at the initial startup: K 16001) Note 3)	
	Resolution	0.1 °C
	Sampling cycle Note 5)	300 ms: when using 2 channels for an input points Note 4) 500 ms: when using 4 channels for an input points Note 4) 700 ms: when using 6 channels for an input points Note 4) 900 ms: when using 8 channels for an input points Note 4)
Overall accuracy	Range for K and J (-100 to 500 °C): ±0.8 °C or less Range for T (-100 to 400 °C): ±0.8 °C or less Range for R (0 to 99.9 °C): ±3 °C or less (100 to 299.9 °C): ±2.5 °C or less (300 to 1500 °C): ±2 °C or less	
Input impedance	more than 1 MΩ	
Insulation method	• Between thermocouple input terminals and control unit internal circuits: Photo-coupler insulation/DC-DC insulation • Between thermocouple input terminal channels: PhotoMOS relay insulation	
Input/Output points	Input: 32 points Note 6)	

- Notes
- 1) The measurement range available for degree Celsius is not available for degree Fahrenheit, of which the upper-limit measurement is set lower than degree Celsius, since the digital value (temperature value displayed) for degree Fahrenheit is bigger than that for degree Celsius.
 - 2) When the thermocouple is broken, the digital value will become K8000 or K16000 within 70 seconds since broken. Practice in the ladder program a process for avoiding a risk, would be resulting from a broken thermocouple, and exchange the thermocouple.
 - 3) Until the conversion data will be ready after the initial startup was made, the digital value shows K8001 or K16001. Those are not a temperature data. Create a ladder program, so that they are not acquired as a temperature data.
 - 4) The settings of the input channel selection switch.
 - 5) Conversion values for 6-time measurements (6 from the latest 8 measurements, excluding the max. and min.) are averaged, so that it takes time for the digital value to be displayed due to the rapid temperature change.
 - 6) The control unit reads the data for 2 channels per 1 scan by the control unit. Read data by utilizing the sample program given in the product specifications and manual.

■ CC-Link slave unit specifications

1. Communication specifications

Version	CC-Link Ver.1.10		
Communication method	Broadcast polling method		
Transmission speed	10 Mbits/s, 5 Mbits/s, 2.5 Mbits/s, 625 kbits/s, 156 kbits/s		
Max. transmission distance Note 1)	Ver.1.10 CC-Link cable	CC-Link cable	
	CC-Link high-performance cable	CC-Link cable	
	10 Mbits/s	100 m	100 m
	5 Mbits/s	160 m	150 m
	2.5 Mbits/s	400 m	200 m
	625 kbits/s	900 m	600 m
	156 kbits/s	1200 m	1200 m
Interface	RS485		
Station type	Remote device station		
Number of occupied stations	FPΣ: 1 to 4 stations (switch changeover), FP0: 1 station		

- Note 1) Length of the multi-drop connected cables at both ends
The cable length has restrictions in communication speed, CC-Link version, and dedicated cables to be used.

For details concerning the CC-Link, refer to the CC-Link Partner Association.

When an FP0 thermocouple unit is used with an FP0 CC-Link slave unit, the measurement accuracy of the thermocouple unit which is installed on the left of the CC-Link slave unit is as shown in the table below.

Thermocouple	Standard specifications	When CC-Link slave unit with a thermocouple unit
K,J,T	0.8 °C	2 °C
R	0 - 99.9 °C	3 °C
	100 - 299.9 °C	2.5 °C
	300 - 1500 °C	2 °C

■ I/O Link unit specifications

Item	Description
Communication method	Two-wire, half duplex
Synchronous method	Asynchronous method
Transmission line	2-wire cable (Twisted-pair cable or VCTF 0.75 mm ² × 2C equivalent)
Transmission distance (Total distance)	Max. 700 m 2,296.588 ft.(using twisted pair cable) Max. 400 m 1,312.336 ft.(using VCTF cable)
Transmission speed (Baud rate)	0.5 Mbits/s
Number of control I/O point per an I/O link unit	64 points (Input: 32 points and Output: 32 points) ^{note)}
Remote I/O map allocation	32X/32Y
Interface	Conforming to RS485
Transmission error check	CRC (Cyclic Redundancy Check) method

Note: This point number is the number of points that can be linked for inputting and outputting via the host PLC and network MEWNET-F. If the output for the I/O link unit error flag is set to ON, this number becomes 63 points (31 input points and 32 output points).

■ FP Web-Server unit specifications

Communication functions	RS232C ↔ Ethernet conversion (PLC remote programming via Ethernet) E-mail sending function Web-server function Transparent communication (Server/Client) PPP server function
Communication interface	RS232C terminal block 3-pin: Mainly used for PLC connection RS232C D-Sub 9-pin: Mainly used for Modem connection 10 BASE-T (RJ45): Used for Ethernet connection and setup
RS232C communication	Transmission speed: 1200, 2400, 4800, 9600, 19200, 38400, 57600, 115200 bits/s Data length: 7 bits/8 bits, Parity: Even/Odd/None
Ethernet communication	10 M bit/s (10BASE-T: RJ45)
Supported protocol	TCP, UDP, IP, DHCP, FTP, TELNET, HTTP, SMTP, and PPP
Memory size	Approx. 148 kB (for storing htm files)
Setup method	Setup using FP Web Configurator Tool

■ Power supply unit specifications

Product number	FP0-PSA4	FP0-PSA1	
Part number	AFP0634	AFP0631	
Input	Rated voltage	100 to 240 V AC	
	Variable input voltage range	85 to 264 V AC	
	Rated frequency	50/60 Hz	
	Frequency range	47 to 63 Hz	
	Number of phases	Single-phase	
	Surge current	30 A (0 - P) or less, with cold start	
	Leakage current	0.75 mA or less	
	Allowable momentary power off time	10 ms or more	
Output	Rated voltage	24 V DC	
	Voltage accuracy	±5%	
	Rated current	0.7 A ^{Note)}	0.6 A
	Output current range	0 to 0.7 A	0 to 0.6 A
	Ripple voltage	500 mV or less	
Protective functions	Over-current protection	0.735 A or more	0.63 A or more
	Over-voltage protection	Available	

Note: Start up may not be possible if a device with a large inrush current is connected even if below the rated current. In such a case, we recommend suppressing the inrush current by inserting a 1 to 2Ω resistor between the power supply unit and the device.

Applicable crimp terminals

Manufacturer	Part number	Applicable wiring
JST Mfg.Co.,Ltd.	V1.25-M3 (round type)	0.35 to 1.65 mm ² AWG #22 to #15
	V1.25-S3A (fork type)	
	V2-M3 (round type)	1.04 to 2.00 mm ² AWG #17 to #14
	V2-S3A (fork type)	

7.2 mm .283 inch or less

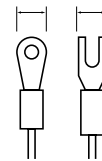

■ Current consumption

Type of unit		Control unit current consumption	Expansion unit current consumption
		This refers to the current consumed via the power supply connector of the control unit. If expansion units or intelligent units are added, the current is increased by the value indicated below.	This refers to the current consumed via the power supply connector of the expansion unit. Units with no value indication don't have a power supply connector.
FP0 control unit	FP0-C10	100 mA or less	—
	FP0-C14	100 mA or less	—
	FP0-C16	40 mA or less	—
	FP0-C32	60 mA or less	—
	FP0-T32		
S-LINK control unit	FP0-SL1	150 mA or less	—
FP0 expansion unit	FP0-E8X	10 mA or less	—
	FP0-E8R	15 mA or less	50 mA or less
	FP0-E8YR	10 mA or less	100 mA or less
	FP0-E8YT/P	15 mA or less	—
	FP0-E16X	20 mA or less	—
	FP0-E16R	20 mA or less	100 mA or less
	FP0-E16T/P	25 mA or less	—
	FP0-E16YT/P	25 mA or less	—
	FP0-E32T/P	40 mA or less	—
FP0 intelligent unit	FP0-A21	20 mA or less	100 mA or less
	FP0-A80	20 mA or less	60 mA or less
	FP0-A04V	20 mA or less	100 mA or less
	FP0-A04I	20 mA or less	130 mA or less
	FP0-TC4	25 mA or less	—
	FP0-TC8		
Link/Communication units	FP0-CCLS	40 mA or less	40 mA or less
	FP0-IOL	30 mA or less	40 mA or less
	FP-WEB	—	95 mA or less (at 24 V DC), 240 mA or less (at 12 V DC)
	AFP15402 (C-NET adapter)	50 mA or less	—

FP0 Product types

① Control units

Product name	Built-in memory (Program capacity)	Specifications					Product number	Part number	
		Number of I/O points	Power supply voltage	Input	Output	Connection type			
FP0 C10 Control Unit	EEPROM (2.7 k steps)	10	Input: 6 Output: 4	24 V DC	24 V DC Sink/Source (\pm common)	Relay output: 2 A	Terminal block	FP0-C10RS	AFP02123
							Molex connector	FP0-C10RM	AFP02113
FP0 C10 Control Unit with RS232C port	EEPROM (2.7 k steps)	10	Input: 6 Output: 4	24 V DC	24 V DC Sink/Source (\pm common)	Relay output: 2 A	Terminal block	FP0-C10CRS	AFP02123C
							Molex connector	FP0-C10CRM	AFP02113C
FP0 C14 Control Unit	EEPROM (2.7 k steps)	14	Input: 8 Output: 6	24 V DC	24 V DC Sink/Source (\pm common)	Relay output: 2 A	Terminal block	FP0-C14RS	AFP02223
FP0 C14 Control Unit with RS232C port	EEPROM (2.7 k steps)	14	Input: 6 Output: 4	24 V DC	24 V DC Sink/Source (\pm common)	Relay output: 2 A	Molex connector	FP0-C14RM	AFP02213
							Terminal block	FP0-C14CRS	AFP02223C
FP0 C16 Control Unit	EEPROM (2.7 k steps)	16	Input: 8 Output: 8	24 V DC	24 V DC Sink/Source (\pm common)	Transistor output: NPN 0.1 A Transistor output: PNP 0.1 A	MIL connector	FP0-C16T	AFP02343
								FP0-C16P	AFP02353
FP0 C16 Control Unit with RS232C port	EEPROM (2.7 k steps)	16	Input: 8 Output: 8	24 V DC	24 V DC Sink/Source (\pm common)	Transistor output: NPN 0.1 A Transistor output: PNP 0.1 A	MIL connector	FP0-C16CT	AFP02343C
								FP0-C16CP	AFP02353C
FP0 C32 Control Unit	EEPROM (5 k steps)	32	Input: 16 Output: 16	24 V DC	24 V DC Sink/Source (\pm common)	Transistor output: NPN 0.1 A Transistor output: PNP 0.1 A	MIL connector	FP0-C32T	AFP02543
								FP0-C32P	AFP02553
FP0 C32 Control Unit with RS232C port	EEPROM (5 k steps)	32	Input: 16 Output: 16	24 V DC	24 V DC Sink/Source (\pm common)	Transistor output: NPN 0.1 A Transistor output: PNP 0.1 A	MIL connector	FP0-C32CT	AFP02543C
								FP0-C32CP	AFP02553C
FP0 T32 Control Unit with RS232C port and Clock/Calendar function	EEPROM (10 k steps)	32	Input: 16 Output: 16	24 V DC	24 V DC Sink/Source (\pm common)	Transistor output: NPN 0.1 A Transistor output: PNP 0.1 A	MIL connector	FP0-T32CT	AFP02643C
								FP0-T32CP	AFP02653C
FP0 S-LINK Control Unit with RS232C port	EEPROM (5 k steps)	128 (S-LINK section)	Input: 64 Output: 64	24 V DC	—	—	Terminal block	FP0-SL1	AFP02700

② Expansion units

Product name	Specifications					Product number	Part number	
	Number of I/O points	Power supply voltage	Input	Output	Connection type			
FP0 E8 Expansion Unit	8	Input: 8	—	24 V DC Sink/Source (\pm common)	—	MIL connector	FP0-E8X	AFP03003
	8	Input: 4 Output: 4	24 V DC	24 V DC Sink/Source (\pm common)	Relay output: 2 A	Terminal block	FP0-E8RS	AFP03023
	8	Output: 8	—	—	Relay output: 2 A	Molex connector	FP0-E8RM	AFP03013
	8	Output: 8	—	—	Relay output: 2 A	Terminal block	FP0-E8YRS	AFP03020
FP0 E16 Expansion Unit	16	Input: 16	—	24 V DC Sink/Source (\pm common)	—	MIL connector	FP0-E16X	AFP03303
	16	Input: 8 Output: 8	24 V DC	24 V DC Sink/Source (\pm common)	Relay output: 2 A	Terminal block	FP0-E16RS	AFP03323
	16	Input: 8 Output: 8	—	24 V DC Sink/Source (\pm common)	Relay output: 2 A	Molex connector	FP0-E16RM	AFP03313
	16	Input: 8 Output: 8	—	24 V DC Sink/Source (\pm common)	Transistor output: NPN 0.1 A	MIL connector	FP0-E16T	AFP03343
FP0 E32 Expansion Unit	32	Input: 16 Output: 16	—	24 V DC Sink/Source (\pm common)	Transistor output: NPN 0.1 A	MIL connector	FP0-E16P	AFP03353
							FP0-E16YT	AFP03340
FP0 E32 Expansion Unit	32	Input: 16 Output: 16	—	24 V DC Sink/Source (\pm common)	Transistor output: NPN 0.1 A	MIL connector	FP0-E16YP	AFP03350
							FP0-E32T	AFP03543
FP0 E32 Expansion Unit	32	Input: 16 Output: 16	—	24 V DC Sink/Source (\pm common)	Transistor output: NPN 0.1 A	MIL connector	FP0-E32P	AFP03553

Notes 1) The control units and relay output type expansion units come with a power cable (part number AFP0581).

(The transistor output type expansion units need no power cable.)

2) The terminal block type relay output units have 2 terminal blocks (9 pins) made by Phoenix. Use a 2.5 mm .098 inch wide screwdriver.

Preferably use the specific terminal block screwdriver (part number AFP0806, Phoenix type code SZS0, 4 x 2.5 mm .098 inch) or equivalent.

3) The connector-type relay output units have 2 connectors made by Nihon Molex (Molex type code 51067-0900, 9 pins).

Use the specific Molex connector press-fit tool (part number AFP0805, Nihon Molex type code 57189-5000) or equivalent.

4) The transistor output units have a press-fit socket for wire-pressed terminal cable and contacts.

Use the press-fit tool (part number AXYS2000) for wire-pressed terminal cable.

③ Intelligent units

Product name	Specifications		Product number	Part number
FP0 Analog I/O Unit	Input specifications	Number of channels : 2 channels Input range : 0 to 5 V, -10 to +10 V (Resolution: 1/4000) 0 to 20 mA (Resolution: 1/4000)	FP0-A21	AFP0480
FP0 A/D Converter Unit	Output specifications	Number of channels : 1 channels Output range : -10 to +10 V (Resolution: 1/4000) 0 to 20 mA (Resolution: 1/4000)		
FP0 D/A Converter Unit	Input specifications	Number of channels : 8 channels Input range : 0 to 5, -10 to +10 V (Resolution: 1/4000) 0 to 20 mA (Resolution: 1/4000)	FP0-A80	AFP0401
	Output specifications	Number of channels : 4 channels Output range : -10 to +10 V (Resolution: 1/4000) 4 to 20 mA (Resolution: 1/4000)	FP0-A04V	AFP04121
FP0 Thermocouple Unit	K, J, T, R thermocouple, Resolution: 0.1 °C		FP0-A04 I	AFP04123
	K, J, T, R thermocouple, Resolution: 0.1 °C		FP0-TC4	AFP0420
			FP0-TC8	AFP0421

④ Link/communication units

Product name	Specifications	Power supply voltage	Product number	Part number
FP0 CC-Link Slave Unit	This unit is for making the FP0 function as a slave station of the CC-Link. Only one unit can be connected to the furthest right edge of the FP0 expansion bus. Note: Accuracy will change if an FP0 thermocouple unit is used at the same time. For details, please refer to the catalog or to the CC-Link Unit manual.	24 V DC	FP0ñCCLS	AFP07943
FP0 I/O Link Unit	This is a link unit designed to make the FP0 function as a station to MEWNET-F (remote I/O system).	24 V DC	FP0ñIOL	AFP0732
C-NET Adapter S2 Type (for FP0 side)	This is an RS485 adapter designed to allow use of the Computer link function for connecting to a host computer via C-NET. It comes with a 30cm 11.811 inch FP0 tool port cable. A power supply is not required.	—	—	AFP15402
C-NET Adapter (RS485) (for computer side)	This is an RS485 adapter designed to allow use of the Computer link function for connecting to a network-connected PLC via C-NET from a host computer.	100 to 240 V AC	—	AFP8536
		24 V DC	—	AFP8532
FP Web-Server Unit	Unit for connecting FP series/RS232C interface and Ethernet Web-Server function and E-mail sending function	24 V DC	FP-WEB	AFP0610

⑤ Power supply unit

Product name	Specifications	Product number	Part number
FP0 Power Supply Unit	Input voltage: 100 to 240 V AC Output: 0.7 A, 24 V DC	FP0-PSA4	AFP0634

⑥ Programming tools

Product name	Specifications	Part number			
Standard Programming Tool Software Control FPWIN GR Ver.2	English-language menu	Standard Upgrade (to upgrade from Ver.1.1)	AFPS10520 AFPS10520R		
	Chinese-language menu	Standard Upgrade (to upgrade from Ver.1.1)	AFPS10820 AFPS10820R		
	Korean-language menu	Standard	AFPS10920		
	Conforms to IEC61131-3 Programming Tool Software Control FPWIN Pro Ver.5	English-language menu	Full type (for all type FP series PLC) Small type (for FP0, FPΣ, FP1, FP-e and FP-M) Upgrade (for full type)	AFPS50540 AFPS51540 AFPS50540R	
		PC Connection Cable		Between D-sub 9 pins and DIN 5 pins, 3 m length	AFC8503

⑦ Options and additional parts

Product name	Specifications	Part number
FP Memory Loader	Data clear type	AFP8670
	Data hold type	AFP8671
Terminal Screwdriver	Relay output type Necessary when wiring terminals block (Phoenix).	AFP0806
Molex Connector Pressure Contact Tool	Necessary when wiring relay output type and Molex connectors. (MOLEX: 57189-5000)	AFP0805
Multi-Wire Connector Pressure Contact Tool	Necessary when wiring transistor output type connectors.	AXY52000
Slim 30 Type Mounting Plate	Screw-stop attachment plate for 30 mm 1.181 inch width the unit.	AFP0811 (set for 10)
Slim Type Mounting Plate	Screw-stop attachment plate for FP0 expansion unit. Slim model.	AFP0803 (set for 10)
Flat Type Mounting Plate	Screw-stop attachment plate for FP0 control unit. Flat model.	AFP0804 (set for 10)
Relay Output Molex Type I/O Cable	Loose-wiring cable (9 leads) AWG20, with Molex socket attached at one end, 0.5 mm ² , 1 set: 2 cables (blue & white).	Length: 1 m 3.281 ft. AFP0551 (2 cable set)
		Length: 3 m 9.843 ft. AFP0553 (2 cable set)
Transistor Output Type I/O Cable	Wire-pressed terminal cable (10 leads) AWG22, 0.3 mm ² with connectors attached at one end, 1 set: 2 cables (blue & white).	Length: 1 m 3.281 ft. AFP0521 (2 cable set)
		Length: 3 m 9.843 ft. AFP0523 (2 cable set)
Flat Cable Connector for FPΣ/FP0 Transistor Type Unit	If you are using flat cable connector, request the part specified below for a connector with an asymmetrical design to prevent mistaken polarity. (10-pin)	AXM110915
Terminal Socket	Attaches to relay output and terminal block type. Additional part	AFP0802 (2 sockets per pack)
Molex Socket	Attaches to relay output and Molex connector types. Additional part	AFP0801 (2 sockets per pack)
Wire-Press Socket	Attaches to transistor output type. Additional part	AFP0807 (2 sockets per pack)
Power Cable	Attaches to FP0 various units. Additional part Length: 1 m 3.281 ft.	AFP0581 (1 socket per pack)

FP0 Mounting plates

■ Installation and dimensions

● Direct mounting on a panel 1: Use of the slim type mounting plate

The control unit and expansion units can be directly mounted on a panel by using the optional slim type mounting plate.

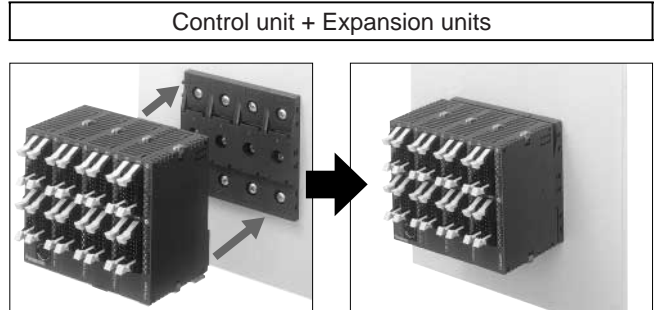
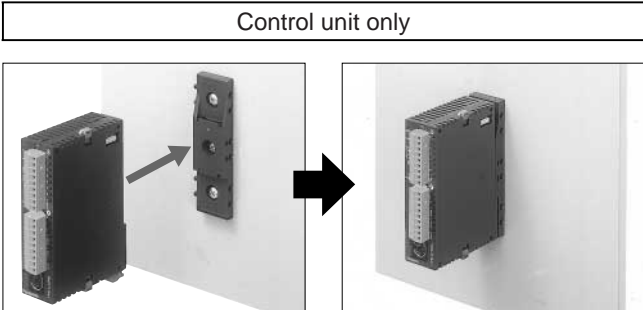

● Mounting dimensions (Unit: mm inch) Slim type mounting plate

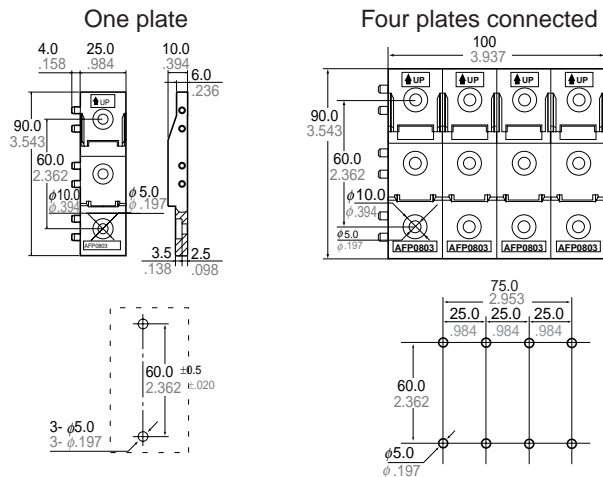

Dimensions after mounting with the slim type mounting plates

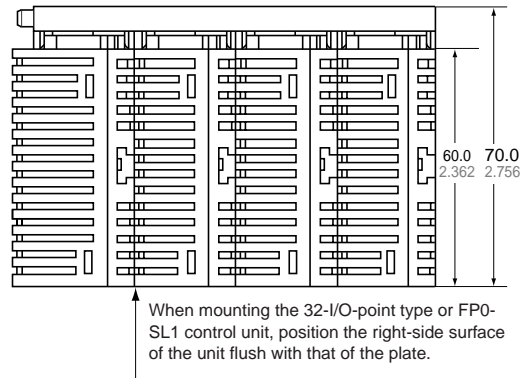

● Direct mounting on a panel 2: Use of the flat type mounting plate (Note: Expansion is impossible.)

The control unit can be directly mounted on a panel by using the optional flat type mounting plate.

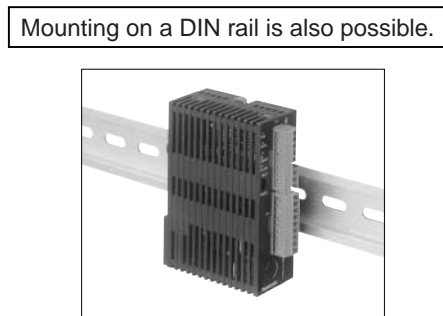
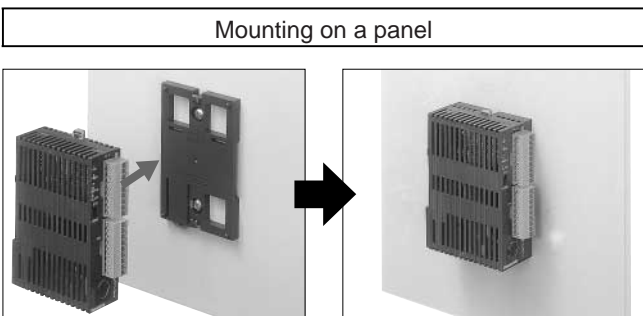

● Mounting dimensions (Unit: mm inch) Flat type mounting plate

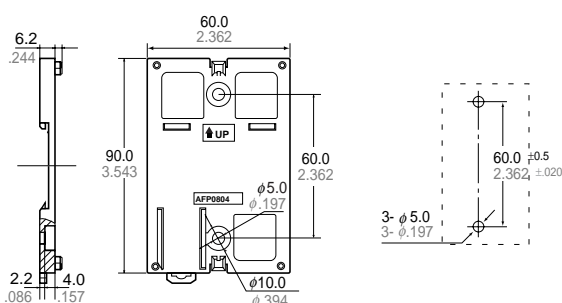

Dimensions after mounting with the flat type mounting plate

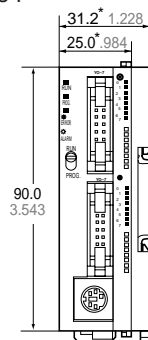

* When mounting the 32-I/O-point type or FP0-SL1 control unit, these dimensions increase by 5 mm .197 inch each.

FPO options

Wiring tools

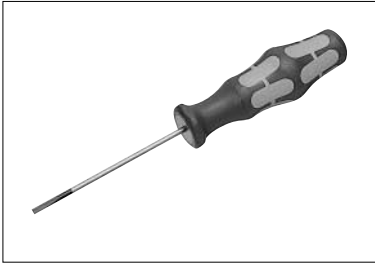

Terminal screwdriver

Necessary when wiring relay output type and terminals block (Phoenix).

Part number: **AFP0806**



Molex connector pressure contact tool

Necessary when wiring connector type and relay output

Part number: **AFP0805**



Multi-wire connector pressure contact tool

Necessary when wiring transistor output type connectors.

Part number: **AXY52000**

Parts for mounting

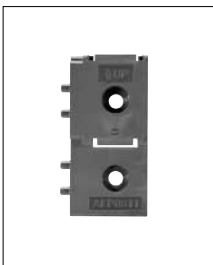

Slim 30 type mounting plate

Screw-stop attachment plate.
30 mm 1.181 inch width type

Part number: **AFP0811** (set of 10)

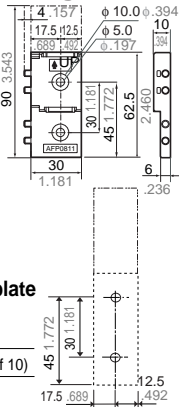

Slim type mounting plate

Screw-stop attachment plate.
Slim model.

Part number: **AFP0803** (set of 10)

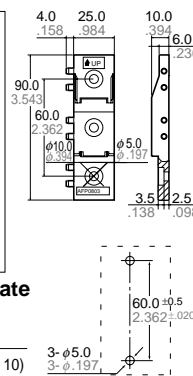

Flat type mounting plate

Screw-stop attachment plate.
Flat model.

Part number: **AFP0804** (set of 10)

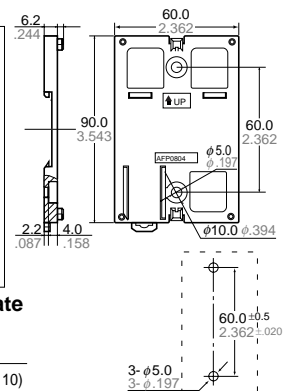

I/O cables

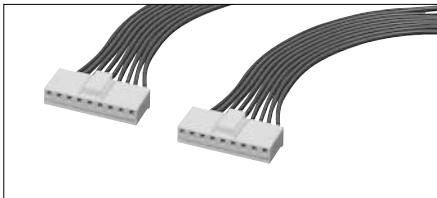

Relay output Molex type I/O cable

Loose-wiring cable (9 leads) AWG20, with Molex socket attached at one end, 0.5 mm², 1 set: 2 cables (blue & white).

<Length: 1 m 3.281 ft.>
2 cable set

<Length: 3 m 9.843 ft.>
2 cable set

Part number: **AFP0551**

Part number: **AFP0553**

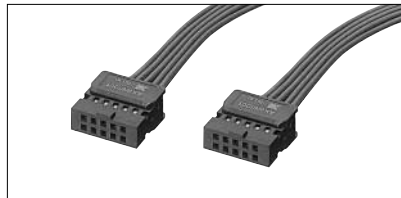

Transistor output type I/O cable

Wire-pressed terminal cable (10 leads) AWG22, 0.3 mm² with connectors attached at one end, 1 set: 2 cables (blue & white).

<Length: 1 m 3.281 ft.>
2 cable set

<Length: 3 m 9.843 ft.>
2 cable set

Part number: **AFP0521**

Part number: **AFP0523**

Flat cable connector

If you are using flat cable connector, request the part specified below for a connector with an asymmetrical design to prevent mistaken polarity.

Part number: **AXM110915**

Notes:

- One I/O cable set (2 cables) is necessary with the following models: FP0-C10RS/C10RM, C14RS/C14RM, E8RS/E8RM, E16RS/E16RM
- One I/O cable set (2 cables) is necessary with the following models: FP0-C16T/C16P/E16X/E16T/E16P/E16YT/E16YP
- Two I/O cable sets (total 4 cables) are necessary with the following models: FP0-C32T/C32P/E32T/E32P

Additional parts

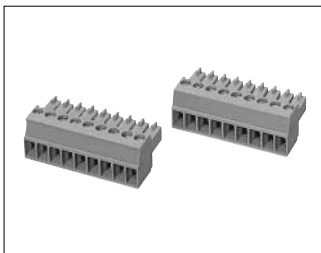

Terminal socket

Attaches to relay output and terminal block type. Additional part

Part number: **AFP0802**
(2 sockets per pack)

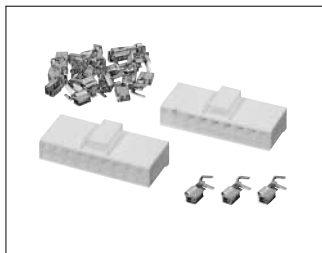

Molex socket

Attaches to relay output and Molex connector types. Additional part

Part number: **AFP0801**
(2 sockets per pack)

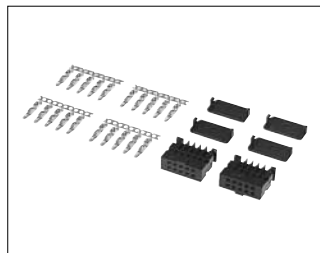

Wire-press socket

Attaches to transistor output type. Additional part

Part number: **AFP0807**
(2 sockets per pack)



Power cable

Attaches to control unit and relay output type expansion unit. Additional part

Length: 1 m 3.281ft. Part number: **AFP0581**
(1 cable per pack)

FP0 Dimensions

■ **Control units and expansion units** * For the relay output type, the terminal block type is listed as the representative type.

FP0-C10RS/C10RM/C10CRS/C10CRM/C14RS/C14RM/C14CRS/C14CRM FP0-E8RS/E8RM/E8YRS/E16RS/E16RM

● External dimensions (unit: mm inch)

<Reference measuring for wiring>

● Terminal array

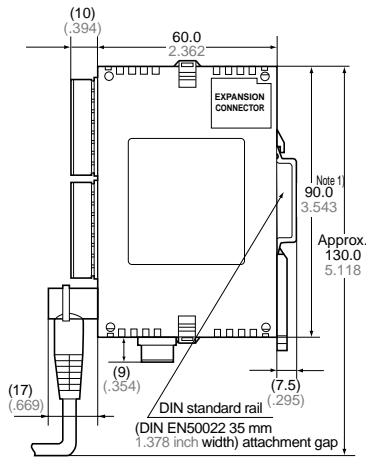
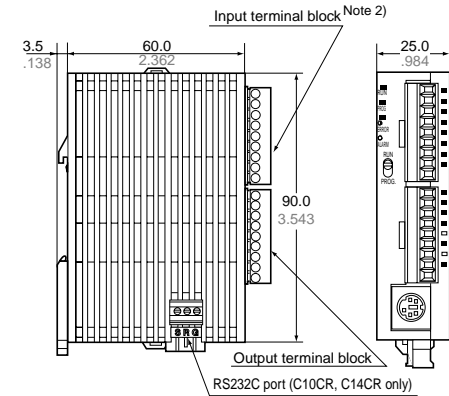

	C10RS/C10RM/ C10CRS/C10CRM	C14RS/C14RM/ C14CRS/C14CRM	E8RS/E8RM	E16RS/E16RM/ E8YRS
Input	X0	X0	X0	X0
	X1	X1	X1	X1
	X2	X2	X2	X2
	X3	X3	X3	X3
	X4	X4	(NC)	X4
	X5	X5	(NC)	X5
	(NC)	X6	(NC)	X6
	(NC)	X7	(NC)	X7
COM	COM	COM	COM	
Output	Y0	Y0	Y0	Y0
	Y1	Y1	Y1	Y1
	(NC)	Y2	Y2	Y2
	(NC)	Y3	Y3	Y3
	COM	COM	(NC)	Y4
	Y2	COM	(NC)	Y5
	COM	COM	(NC)	Y6
	Y3	COM	(NC)	Y7
COM	COM	COM	COM	

Notes:

- 1) DIN rail is attached on the center of the unit.
- 2) The FP0-E8YRS is not equipped with an input terminal block.

FP0-C16T/C16P/C16CT/C16CP/E16T/E16P/E8X/E8YT/E8YP

● External dimensions (unit: mm inch)

<Reference measuring for wiring>

● Terminal array

● RS232C port

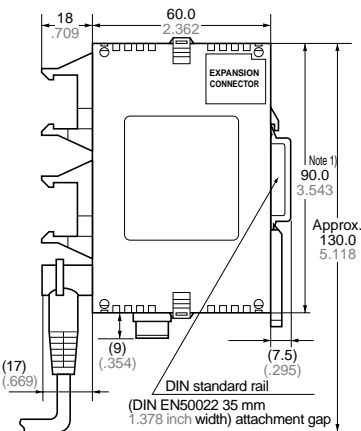
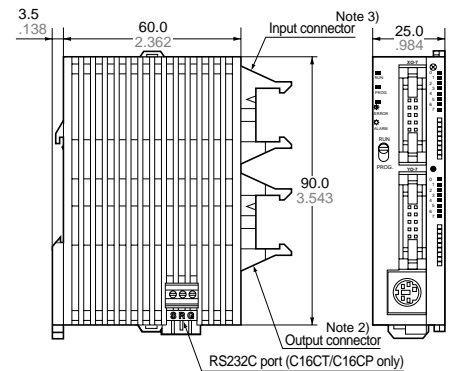

Input (8 points/common)

X0	X1
X2	X3
X4	X5
X6	X7
COM	COM

Terminal array

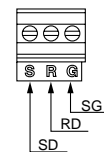

Output (8 points/common)

Y0	Y1
Y2	Y3
Y4	Y5
Y6	Y7
(+)	(-)

Note: Two COM terminals on the input circuit are connected inside the unit.

Notes:

- 1) DIN rail is attached on the center of the unit.
- 2) The FP0-E8X has no output connector.
- 3) The FP0-E8YT and E8YP has no input connector.

FP0-C32T/C32P/C32CT/C32CP/E32T/E32P/E16X/E16YT/E16YP

● External dimensions (unit: mm inch)

<Reference measuring for wiring>

● Terminal array

● RS232C port

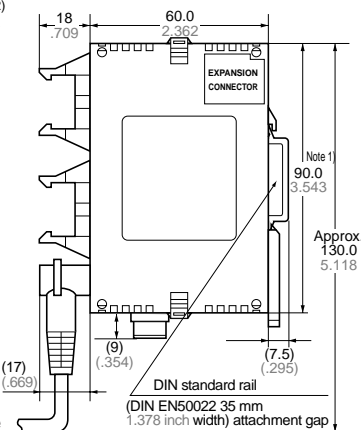
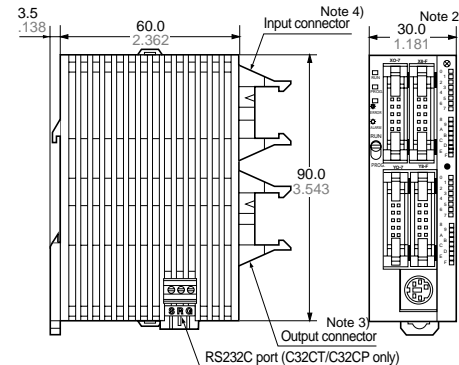

Input (16 points/common)

X0	X1	X8	X9
X2	X3	XA	XB
X4	X5	XC	XD
X6	X7	XE	XF
COM	COM	COM	COM

Terminal array

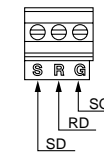

Output (16 points/common)

Y0	Y1	Y8	Y9
Y2	Y3	YA	YB
Y4	Y5	YC	YD
Y6	Y7	YE	YF
(+)	(-)	(+)	(-)

Notes:

- 1) Four COM terminals on the input circuit are connected inside the unit.
- 2) Two (+) terminals and two (-) terminals on the output circuit are connected respectively inside the unit.

Notes:

- 1) DIN rail is attached on the center of the unit.
- 2) The FP0-E32T, E32P, E16X, E16YT and E16YP are 25 mm .984 inch each.
- 3) The FP0-E16X has no output connector.
- 4) The FP0-E16YT and E16YP have no input connector.

FP0 S-LINK Control Unit

● External dimensions
(unit: mm inch)

● RS232C port
Terminal array

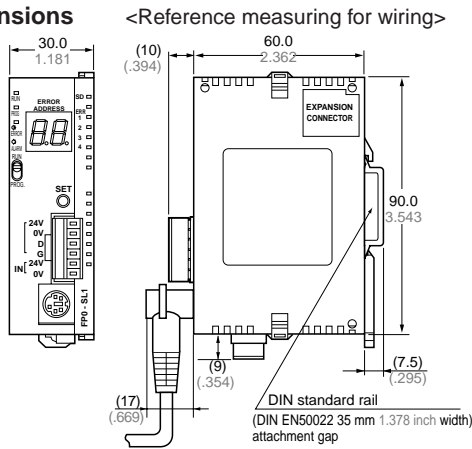
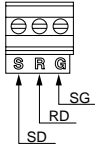

FP0 Analog I/O Unit, D/A Converter Unit

● External dimensions
(unit: mm inch)

<Reference measuring for wiring>

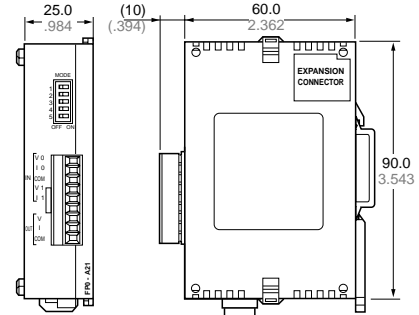

FP0 A/D Converter Unit, Thermocouple Unit

● External dimensions
(unit: mm inch)

<Reference measuring for wiring>

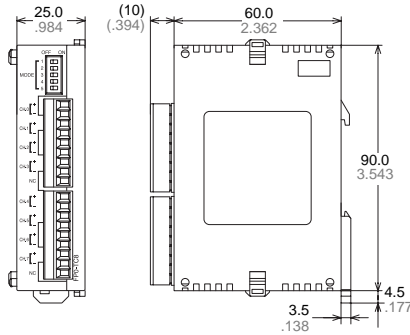

FP0 CC-Link Unit, I/O Link Unit

● External dimensions
(unit: mm inch)

<Reference measuring for wiring>

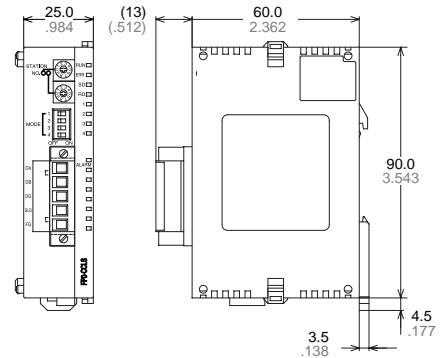

FP0 Web-Server Unit

● External dimensions
(unit: mm inch)

<Reference measuring for wiring>

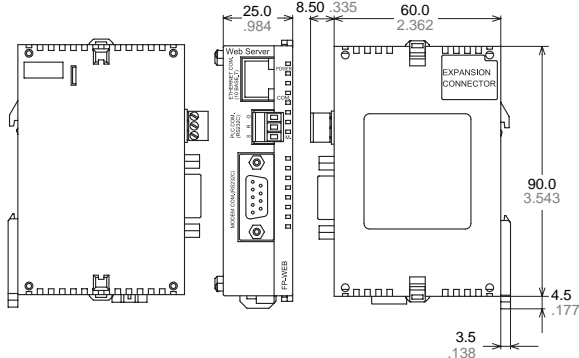

FP0 Power Supply Unit

● External dimensions
(unit: mm inch)

<Reference measuring for wiring>

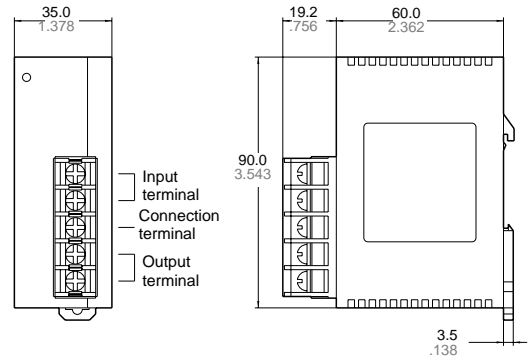

External Dimensions During Expansions

● Top view
(with DIN rail attached)

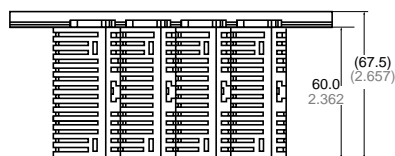

● Front view

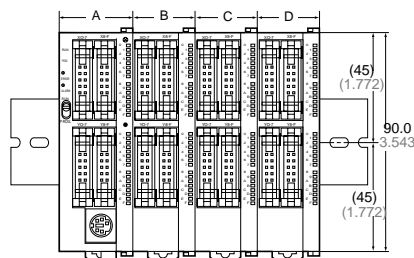

A+B+C+D dimensions

Control unit type	A Control unit only	A+B 1 expansion unit connected	A+B+C 2 expansion units connected	A+B+C+D 3 expansion units connected
FP0-C10CRS FP0-C10CRS FP0-C10RM FP0-C10CRM FP0-C14RS FP0-C14CRS FP0-C14RM FP0-C14CRM FP0-C16T FP0-C16P FP0-C16CT FP0-C16CP	25 mm .984 inch	50 mm 1.969 inch	75 mm 2.953 inch	100 mm 3.937 inch
FP0-C32T FP0-C32P FP0-C32CT FP0-C32CP FP0-SL1 FP0-T32CT FP0-T32CP	30 mm 1.181 inch	55 mm 2.165 inch	80 mm 3.150 inch	105 mm 4.134 inch

Please contact

Panasonic Electric Works Co., Ltd.

Automation Controls Business Unit

■ Head Office: 1048, Kadoma, Kadoma-shi, Osaka 571-8686, Japan

■ Telephone: +81-6-6908-1050 ■ Facsimile: +81-6-6908-5781

panasonic-electric-works.net/ac

Panasonic[®]

All Rights Reserved © 2010 COPYRIGHT Panasonic Electric Works