

6

5

4

3

2

1

APPROVED: _____

DATE: _____ TITLE: _____

Rev	AWO #	Description	Date	Appr
-		RELEASED	8/23/22	

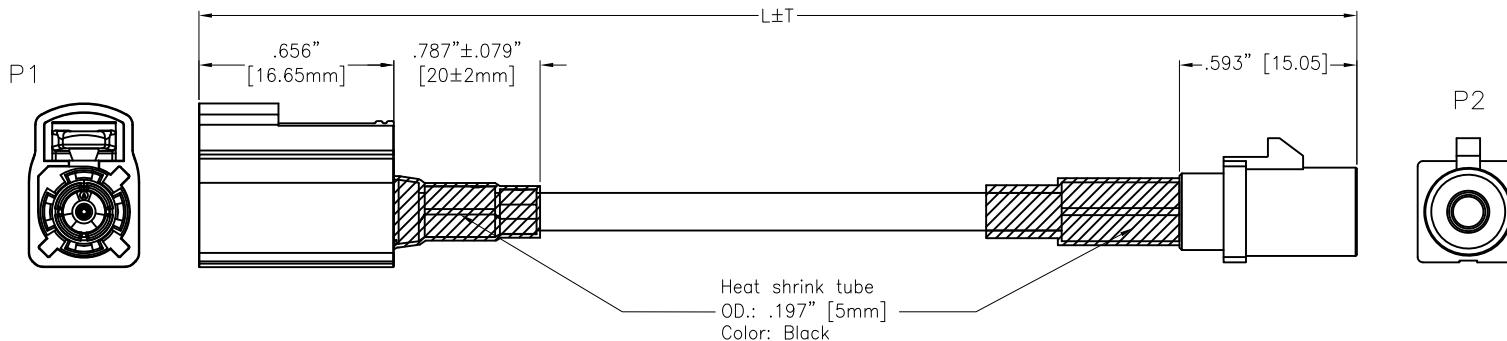

CA-FJFM-XX001X

ADAM P/N	L+T	
CA-FJFM-XX0011	39.370" ± 1.181"	1000 ± 30mm
CA-FJFM-XX0012	78.740" ± 1.969"	2000 ± 50mm

SPECIFICATIONS:

Connector:

P1= FAKRA Jack Code See page2, Straight, Thermoplastic, 30u" Gold Plated

P2= FAKRA Plug Code See page3, Straight, Teflon, Gold flash Plated

Cable:

RTK-031 22AWG, Coaxial+Al-mylar+Braid, OD.: .130" [3.3mm] PVC, Jacket Color: Black

Electrical:

Impedance: 50ohm

Temperature Rating:

Operating temperature: -40°C to +105°C

Electrical Test:

All Assemblies must be 100% Tested for Shorts, Open, Continuity, and Physical Appearance.

Environmental:

Lead free, RoHS compliant



UNLESS OTHERWISE SPECIFIED ALL DIMENSIONS ARE INCHES [MM]. TOLERANCES: EXCEPT AS NOTED		
INCHES		HOLES
.X ±.10	Ø.X ±.10	
.XX ±.020	Ø.XX ±.015	
.XXX ±.015	Ø.XXX ±.010	
DRAWN	LH	8/23/22
CHECKED	RC	8/23/22
APPROVED		
THIS DRAWING CONTAINS INFORMATION THAT IS PROPRIETARY AND SHOULD NOT BE USED WITHOUT PRIOR WRITTEN PERMISSION FROM ADAM TECH		

ADAM TECH 909 Rahway Avenue, Union, NJ 07083
Phone: 908-687-5000 Fax: 908-687-5710

TITLE CUSTOM CABLE ASSEMBLY, FAKRA JACK STRAIGHT TO FAKRA PLUG STRAIGHT, RTK031, 22AWG		
SIZE X	PART NO. CA-FJFM-XX001X	REV. -
REF: S00013T	SCALE: NTS	SHEET 1 OF 3

6

5

4

3

2

1

6

5

4

3

2

1

APPROVED: _____

DATE: _____ TITLE: _____

Rev	AWO #	Description	Date	Appr
-----	-------	-------------	------	------

SEE SH1 1 OF 3 FOR REVISION

Fakra Jack

CA-FJFM-XX001X

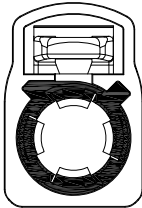
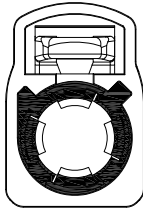
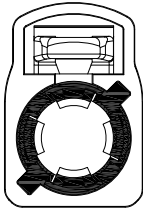
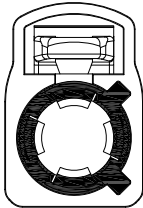
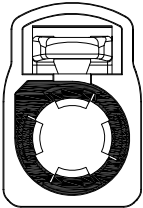
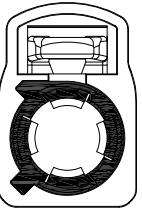
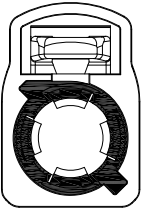
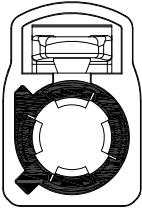
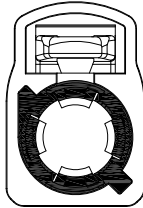
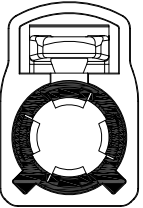
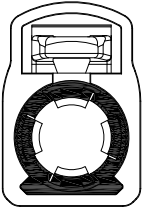
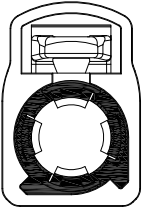
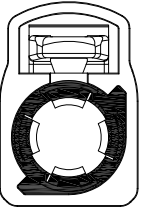
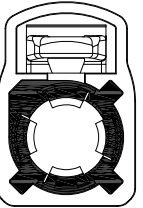
Coding	A	B	C	D	E	F	G
Jack							
Color	Black	White	Blue	Bordeaux Violet	Green	Brown	Grey
Coding	H	I	K	L	M	N	Z
Jack							
Color	Violet	Beige	Curry	Carmine Red	Pastel Orange	Pastel Green	Water Blue

UNLESS OTHERWISE SPECIFIED ALL DIMENSIONS ARE INCHES [MM]. TOLERANCES: EXCEPT AS NOTED

INCHES		HOLES	
.X	± .10	∅.X	± .10
.XX	± .020	∅.XX	± .015
.XXX	± .015	∅.XXX	± .010

ADAM
TECH

909 Rahway Avenue,
Union, NJ 07083
Phone: 908-687-5000
Fax: 908-687-5710

DRAWN	LH	8/23/22
CHECKED	RC	8/23/22
APPROVED		

TITLE
CUSTOM CABLE ASSEMBLY, FAKRA JACK STRAIGHT
TO FAKRA PLUG STRAIGHT, RTK031, 22AWG

THIS DRAWING CONTAINS INFORMATION THAT IS PROPRIETARY AND SHOULD NOT BE USED WITHOUT PRIOR WRITTEN PERMISSION FROM ADAM TECH

SIZE X	PART NO. CA-FJFM-XX001X	REV. -
-----------	----------------------------	-----------

REF: S00013T SCALE: NTS SHEET 2 OF 3

6

5

4

3

2

1

6

5

4

3

2

1

APPROVED: _____

DATE: _____ TITLE: _____

Rev	AWO #	Description	Date	Appr
-----	-------	-------------	------	------

SEE SHT 1 OF 3 FOR REVISION

CA-FJFM-XX001X

Fakra Plug

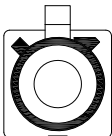
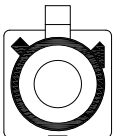
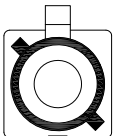
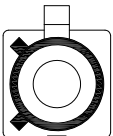
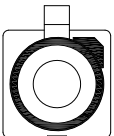
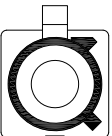
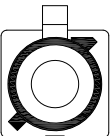
Coding	A	B	C	D	E	F	G
Plug							
Color	Black	White	Blue	Bordeaux Violet	Green	Brown	Grey

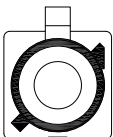
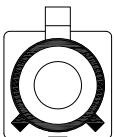
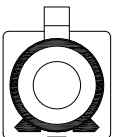
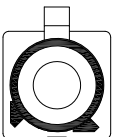
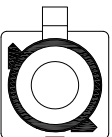
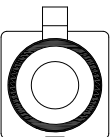
Coding	H	I	K	L	M	N	Z
Plug							
Color	Violet	Beige	Curry	Camine Red	Pastel Orange	Pastel Green	Water Blue

UNLESS OTHERWISE SPECIFIED ALL DIMENSIONS ARE INCHES [MM]. TOLERANCES: EXCEPT AS NOTED

INCHES		HOLES	
.X	± .10	Ø.X	± .10
.XX	± .020	Ø.XX	± .015
.XXX	± .015	Ø.XXX	± .010

ADAM
TECH

909 Rahway Avenue,
Union, NJ 07083
Phone: 908-687-5000
Fax: 908-687-5710

DRAWN	LH	8/23/22
CHECKED	RC	8/23/22
APPROVED		

TITLE
CUSTOM CABLE ASSEMBLY, FAKRA JACK STRAIGHT
TO FAKRA PLUG STRAIGHT, RTK031, 22AWG

THIS DRAWING CONTAINS INFORMATION THAT IS PROPRIETARY AND SHOULD NOT BE USED WITHOUT PRIOR WRITTEN PERMISSION FROM ADAM TECH

SIZE X	PART NO. CA-FJFM-XX001X	REV. -
REF: S00013T	SCALE: NTS	SHEET 3 OF 3

6

5

4

3

2

1