

LED machine light - PLD M 160 W-95/105 196 - 2702475

Please be informed that the data shown in this PDF Document is generated from our Online Catalog. Please find the complete data in the user's documentation. Our General Terms of Use for Downloads are valid (<http://phoenixcontact.com/download>)



LED machine light, 24 V DC, emission angle 95 °/105 °, color temperature 6200 K, length 196 mm, Light housing: Anodized aluminum, Light cover: Satined acrylic, pivoting, including mounting accessories

Product Description

This LED machine light is designed to provide illumination inside or on machinery. Due to the narrow design, it can be mounted even where space is at a premium. In the light holder supplied, the light can swivel and the lighting can therefore be optimally aligned. The satin-finished plastic cover prevents glare for the machine operator.

Your advantages

- ✓ Narrow design enables mounting even in confined spaces
- ✓ Ready to connect by means of punched-on 3 m supply line
- ✓ Focused illumination, thanks to swivel action
- ✓ IP67 protection enables use even in wet environments
- ✓ ETL approval permits use on the North American market
- ✓ Particularly economical thanks to energy-efficient LED technology and an LED service life of at least 50,000 h



Key Commercial Data

Packing unit	1 pc
GTIN	 4 055626 213682
GTIN	4055626213682

Technical data

Dimensions

Width	22.5 mm
Height	23 mm
Length	196 mm

Ambient conditions

Ambient temperature (operation)	0 °C ... 40 °C
Ambient temperature (storage/transport)	-10 °C ... 50 °C

LED machine light - PLD M 160 W-95/105 196 - 2702475

Technical data

Ambient conditions

Permissible humidity (operation)	95 %
Permissible humidity (storage/transport)	95 % (non-condensing)
Air pressure (operation)	69 kPa ... 102 kPa
Air pressure (storage/transport)	69 kPa ... 102 kPa
Degree of protection	IP67

General

Net weight	200 g
Mounting type	Screw mounting

Power supply for module electronics

Connection method	open cable end
Cable length	approx. 3 m
Supply voltage	24 V DC
Supply voltage range	22 V DC ... 26 V DC
Current consumption	typ. 0.15 A (at 24 V DC)
Power consumption	approx. 3.5 W (at 24 V DC)
Type of protection	Surge protection
	Reverse polarity protection

Light properties

Source of light type	LED
Number of LEDs	6
Service life, lighting appliance	50,000 h (L70)
Light color	daylight white
Color temperature / wavelength	6200 K ±10 %
Color rendering index	75
Luminous flux	approx. 150 lm (Net luminous flux)
Illumination	max. 206 lx (50 cm distance)
Average illumination	89 lx (Distance of 50 cm over 1 m ² area)
Emission angle	95 ° (C0-C180)

Standards and Regulations

Protection class	III, IEC 61140, EN 61140, VDE 0140-1
------------------	--------------------------------------

Environmental Product Compliance

China RoHS	Environmentally friendly use period: unlimited = EFUP-e
	No hazardous substances above threshold values

Drawings

LED machine light - PLD M 160 W-95/105 196 - 2702475

Diagram

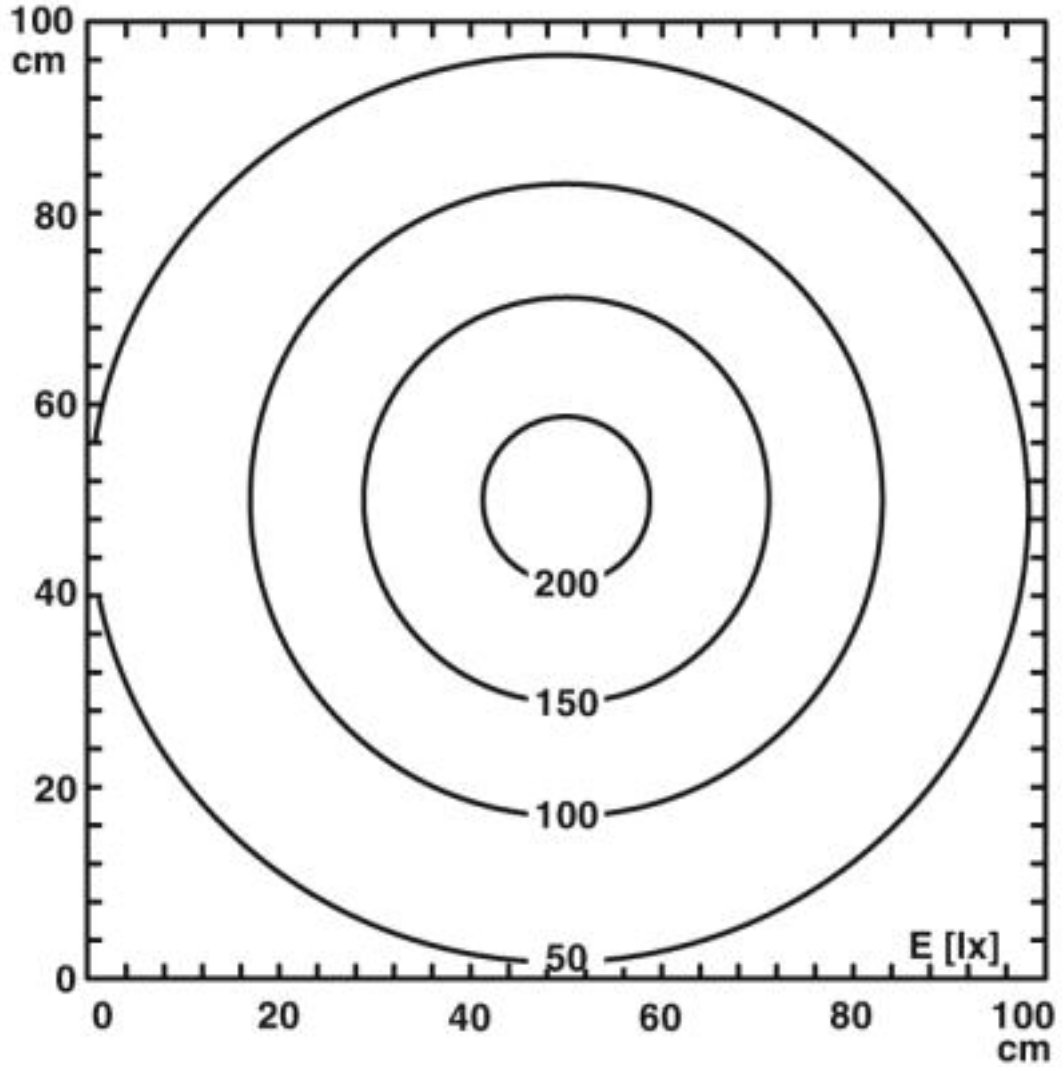

Illuminance distribution
(distance d = 0.5 m)

LED machine light - PLD M 160 W-95/105 196 - 2702475

Diagram

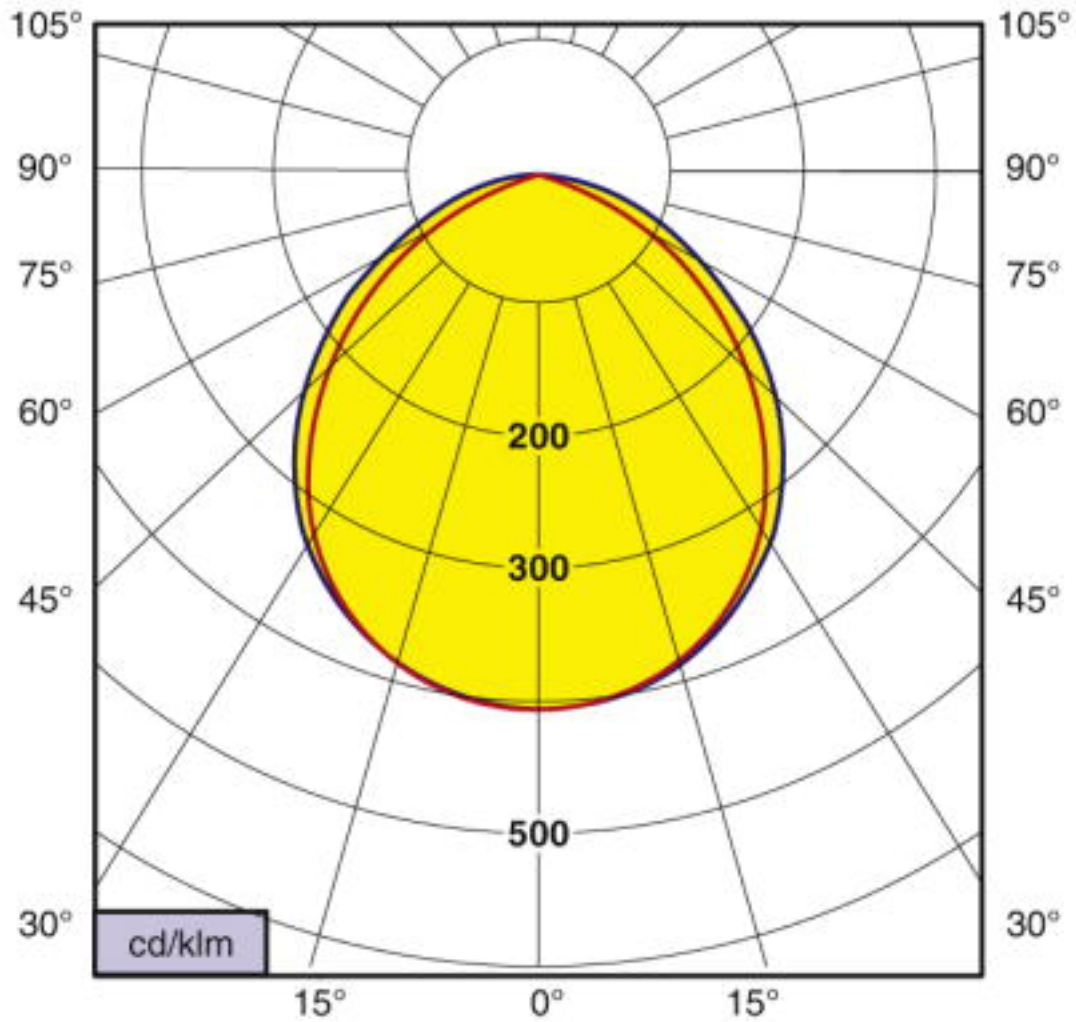

Luminous intensity distribution (LID)
(red line: C0 - C180, blue line: C90 - C270)

Dimensional drawing

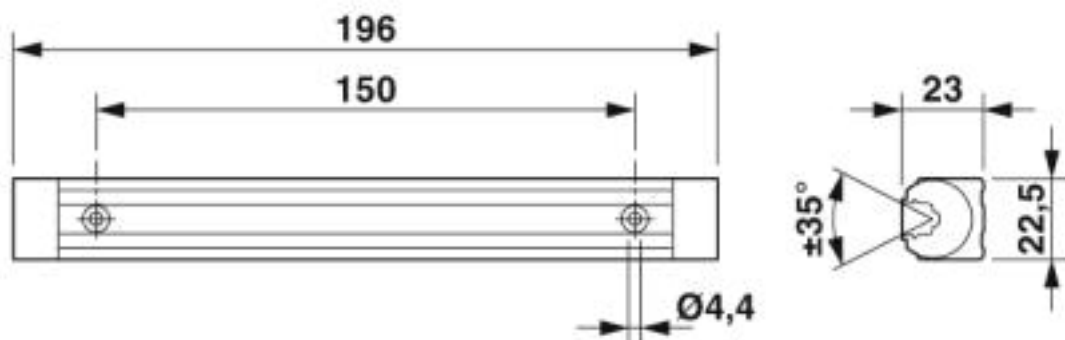

LED machine light - PLD M 160 W-95/105 196 - 2702475

Approvals

Approvals

Approvals

ETLus / cETL / cETLus

Ex Approvals

Approval details

ETLus		http://www.intertek.com	LV-Lighting-Systems
-------	---	---	---------------------

cETL		http://www.intertek.com	Luminaires
------	--	---	------------

cETLus			
--------	---	--	--

Phoenix Contact 2019 © - all rights reserved
<http://www.phoenixcontact.com>

PHOENIX CONTACT GmbH & Co. KG
Flachsmarktstr. 8
32825 Blomberg
Germany
Tel. +49 5235 300
Fax +49 5235 3 41200
<http://www.phoenixcontact.com>