

TMP451EVM User's Guide and Software Tutorial

User's Guide



Literature Number: SBOU131A
June 2013–Revised August 2019

Preface	5
1 Overview	6
1.1 TMP451EVM Kit Contents	6
1.2 Related Documentation from Texas Instruments	6
2 TMP451EVM Hardware Overview and Setup	7
2.1 Board Connectors and Components	7
2.1.1 EVM Power Supply Input – J1	7
2.1.2 Pushbutton Switch – SW1	8
2.1.3 LEDs-D3,5,6	8
2.1.4 Remote BJT - Q1	8
2.2 Hardware Setup	8
3 TMP451EVM Software Overview	9
3.1 TMP451EVM Software Installation	9
3.1.1 Running GUI Online	10
3.1.2 Running GUI on Desktop	12
3.2 Using the TMP451EVM Software	17
3.2.1 Launching and Running the Software	17
3.2.2 Home Tab	17
3.2.3 Quick Start Tab	18
3.2.4 Basic Settings Tab	21
3.2.5 Data Capture Tab	23
3.2.6 Register Tab	25
3.2.7 Collateral	26
4 TMP451EVM Documentation	27
4.1 TMP451EVM Board Schematic	27
4.2 TMP451EVM Board Layout	28
4.3 TMP451 Test Board Bill of Materials	31
Revision History	34

List of Figures

1.	TMP451EVM Hardware	5
2-1.	TMP451EVM Board Top Side.....	7
2-2.	Hardware Setup	8
3-1.	Gallery Home Page	10
3-2.	Cookies Agreement	11
3-3.	TMP451EVM GUI Download From the Gallery	12
3-4.	GUI Composer Runtime Wizard	13
3-5.	TMP451EVM GUI License Agreement	14
3-6.	GUI Composer Installation Directory	15
3-7.	Ready to Install	15
3-8.	Installing GUI Composer Runtime	16
3-9.	TMP451EVM Installation Finish	16
3-10.	TMP451EVM Home Tab	17
3-11.	TMP451EVM Quick Start Tab	18
3-12.	Quick Start Connection Check	19
3-13.	Quick Start Guide	20
3-14.	TMP451EVM Basic Settings Tab	21
3-15.	TMP451EVM Data Capture Tab	23
3-16.	Threshold Sliders.....	24
3-17.	TMP451EVM Register Tab	25
3-18.	TMP451EVM Collateral Tab	26
4-1.	TMP451EVM Schematic	27
4-2.	Top Assembly Layer	28
4-3.	Top Routing Layer	28
4-4.	Ground Layer Routing	29
4-5.	Power Layer Routing	29
4-6.	Bottom Layer Routing	29
4-7.	Bottom Assembly Layer	30

List of Tables

1-1.	Contents of TMP451EVM Kit.....	6
1-2.	Related Documentation	6
4-1.	TMP451EVM Bill of Materials (BOM)	31

TMP451EVM User's Guide and Software Tutorial

This user's guide describes the characteristics, operation, and use of the TMP451EVM evaluation board. It discusses how to set up and configure the software, reviews the hardware, and reviews various aspects of the software operation. Throughout this document, the terms evaluation board, evaluation module, and EVM are synonymous with the TMP451EVM. This user's guide also includes information regarding operating procedures and input/output connections, an electrical schematic, PCB layout drawings, and a parts list for the EVM.

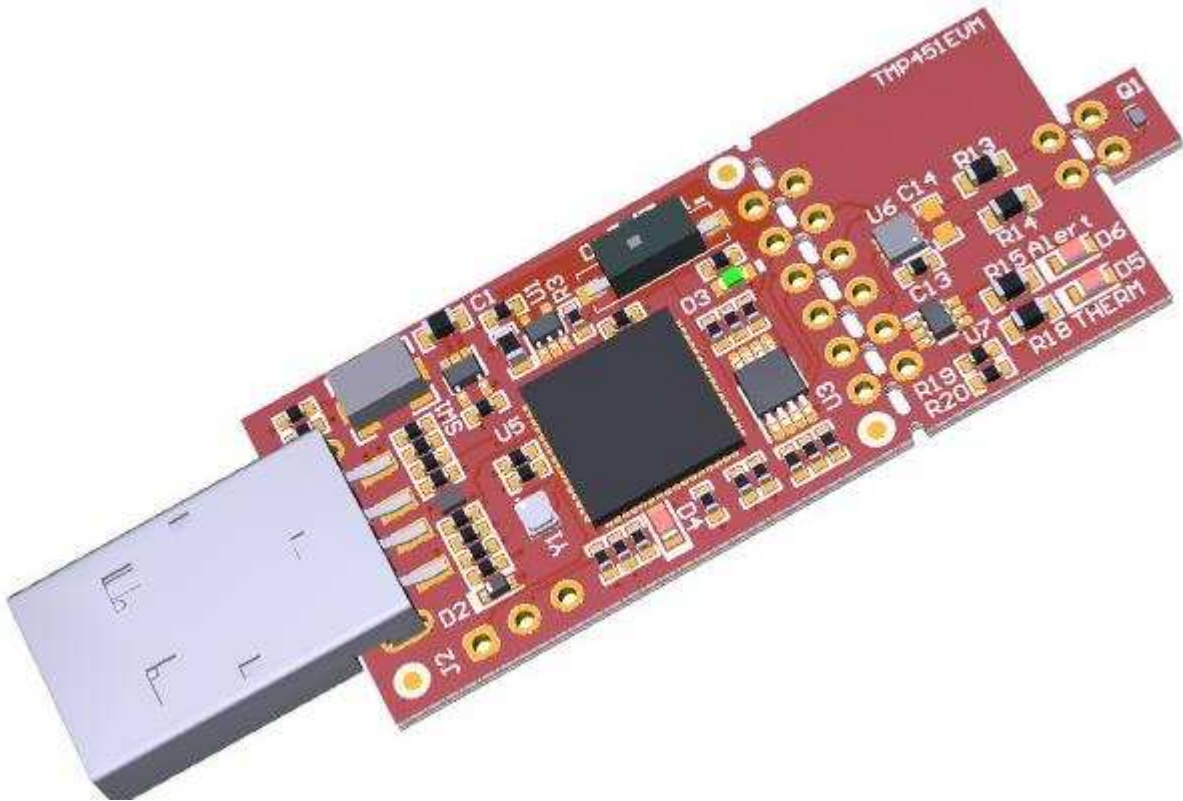

Figure 1. TMP451EVM Hardware

Trademarks

All trademarks are the property of their respective owners.

Overview

The TMP451 is a high-accuracy, low-power remote temperature sensor monitor with a built in local temperature sensor. The remote temperature sensors are typically low-cost discrete NPN or PNP transistors, or on-die transistor or diode structures that are an integral part of microprocessors, microcontrollers, or FPGAs. The temperature accuracy is $\pm 1^{\circ}\text{C}$ for the local and the remote temperature sensors. The two-wire serial interface accepts SMBus communication protocol. The module and GUI are designed to provide the user a quick setup to evaluate the system and register map with simply a few click powered by GUI Composer. The EVM features perforations that allows the temperature sensor, microcontroller, and remote BJT to be isolated and be connected to external systems.

1.1 TMP451EVM Kit Contents

Table 1-1 details the contents of the TMP451EVM kit, and Figure 1 below shows all of the included hardware. Contact the Texas Instruments Product Information Center nearest you if any component is missing. It is highly recommended that you check the TI website at <http://www.ti.com> to verify that you have the latest versions of the related software.

Table 1-1. Contents of TMP451EVM Kit

ITEM	QUANTITY
PCB test board: TMP451EVM	1
USB Cable Extender	1

1.2 Related Documentation from Texas Instruments

The following document provides information regarding Texas Instruments integrated circuits used in the assembly of the TMP451EVM. This user's guide is available from the TI website under literature number [SBOU131](#). Any letter appended to the literature number corresponds to the document revision that is current at the time of the writing of this document. Newer revisions may be available from the TI website at <http://www.ti.com>, or call the Texas Instruments Literature Response Center at (800) 477-8924 or the Product Information Center at (972) 644-5580. When ordering, identify the document by both title and literature number

Table 1-2. Related Documentation

DOCUMENT	LITERATURE NUMBER
TMP451 Product Data Sheet	SBOS686

TMP451EVM Hardware Overview and Setup

This section describes the set up and some of the hardware features present on the TMP451EVM.

WARNING

Many of the components on the TMP451EVM are susceptible to damage by electrostatic discharge (ESD). Customers are advised to observe proper ESD handling precautions when unpacking and handling the EVM, including the use of a grounded wrist strap at an approved ESD workstation.

2.1 Board Connectors and Components

Figure 2-1 shows the top side of the TMP451EVM. Highlighted are the USB connector, breakouts, TMP451 device, and the remote BJT. The USB connector is directly plugged into the computer for power and communication from the computer to the USB2ANY microcontroller. The breakouts are where the perforations are to break off each section to connect to external systems. Headers can also be soldered to the vias to be used as test point and are positioned 100 mils apart to be compatible with a standard breadboard.

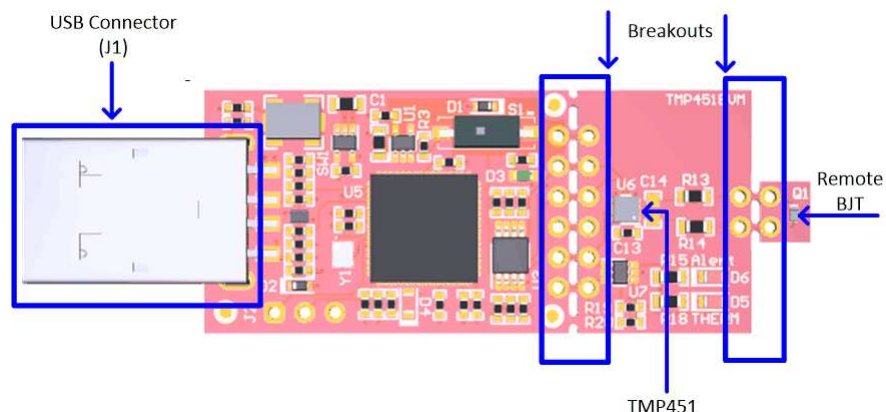

Figure 2-1. TMP451EVM Board Top Side

2.1.1 EVM Power Supply Input – J1

J1 is the USB connector and is used to connect the PC. The interface is used to access the device's registers and read the conversion data from the TMP451 through I2C communication protocol. TMP451EVM uses the +5-V input power supply of the USB connector to power the EVM. The EVM does not require an external power supply. The board is powered by the USB port and provides switched +5 V

2.1.2 Pushbutton Switch – SW1

The SW1 push button is to bring the MSP430 into a BSL mode for upgrading the firmware with combination of the USB connector. Press and hold the switch SW1 next to the USB connector while plugging the USB cable from the board to the PC to bring the MSP430 into BSL mode.

2.1.3 LEDs-D3,5,6

D3 is a green LED that is used to indicate that the EVM has power and should turn on after plugging in the board. D5 is used to indicated a THERM fault and will turn on when the device detects a THERM fault and bring the pin LOW. D6 does the same function but for the ALERT/THERM2 pin. Both these LEDs are red.

2.1.4 Remote BJT - Q1

Q1 is a MMBT3904LP NPN BJT. This is used as the remote temperature sensor on the EVM. The MMBT3904LP typically has an N-factor of about 1.0042. Since the TMP451 assumes an N-Factor of 1.008 this can cause temperature error in the remote temperature reading. The GUI automatically sets the N-Factor correction register to 1.0042 to compensate for this. If the device is reset it will set the N-Factor correction register back to the default value or 1.008 and some temperature error may be seen. If remote temperature error is seen please use the N-Factor correction feature to adjust the temperature reading. The MMBT3904LP can also be broken off to allow for a different temperature remote to be connected.

2.2 Hardware Setup

The TMP451EVM hardware consists of the USB2ANY Platform and the TMP451 altogether in one single board. The unit is easily connected through USB connector into the computer as shown in [Figure 2-2](#). The green LED (D3) should turn on after connecting to the computer, confirming the EVM is powered.



Figure 2-2. Hardware Setup

TMP451EVM Software Overview

This section discusses how to install and use the TMP451EVM software.

3.1 TMP451EVM Software Installation

The EVM software is tested on Microsoft Windows 7 and 10 operating system (OS). The software also functions on other Windows operating systems. The EVM software is available through the EVM product folder on the TI website through the hyperlink. The hyperlink will redirect to the TI Cloud where a common repository of all published applications using GUI Composer framework. The applications can be ran directly from the Gallery with minimal install or download the applications from Gallery with runtime to run on a desktop local machine. The applications is supported to use on many platforms (web, Windows, Linux, OSX); however, Linux and OSX might require additional drivers. To download the software to your system, follow the instructions below.

3.1.1 Running GUI Online

Go to the TMP451EVM web page on the TI website: <http://www.ti.com/tool/TMP451EVM>. Scroll down to the “Software” section and click on the hyperlink to download the latest evaluation software or an alternate way is to connect directly to the gallery by clicking on this link <http://dev.ti.com/gallery/>. It might require login user account privileges to use the online version as well as installation of the applications. On the top middle of the Gallery main page, navigating to search box and type TMP451EVM GUI as shown in the Figure 3-1.

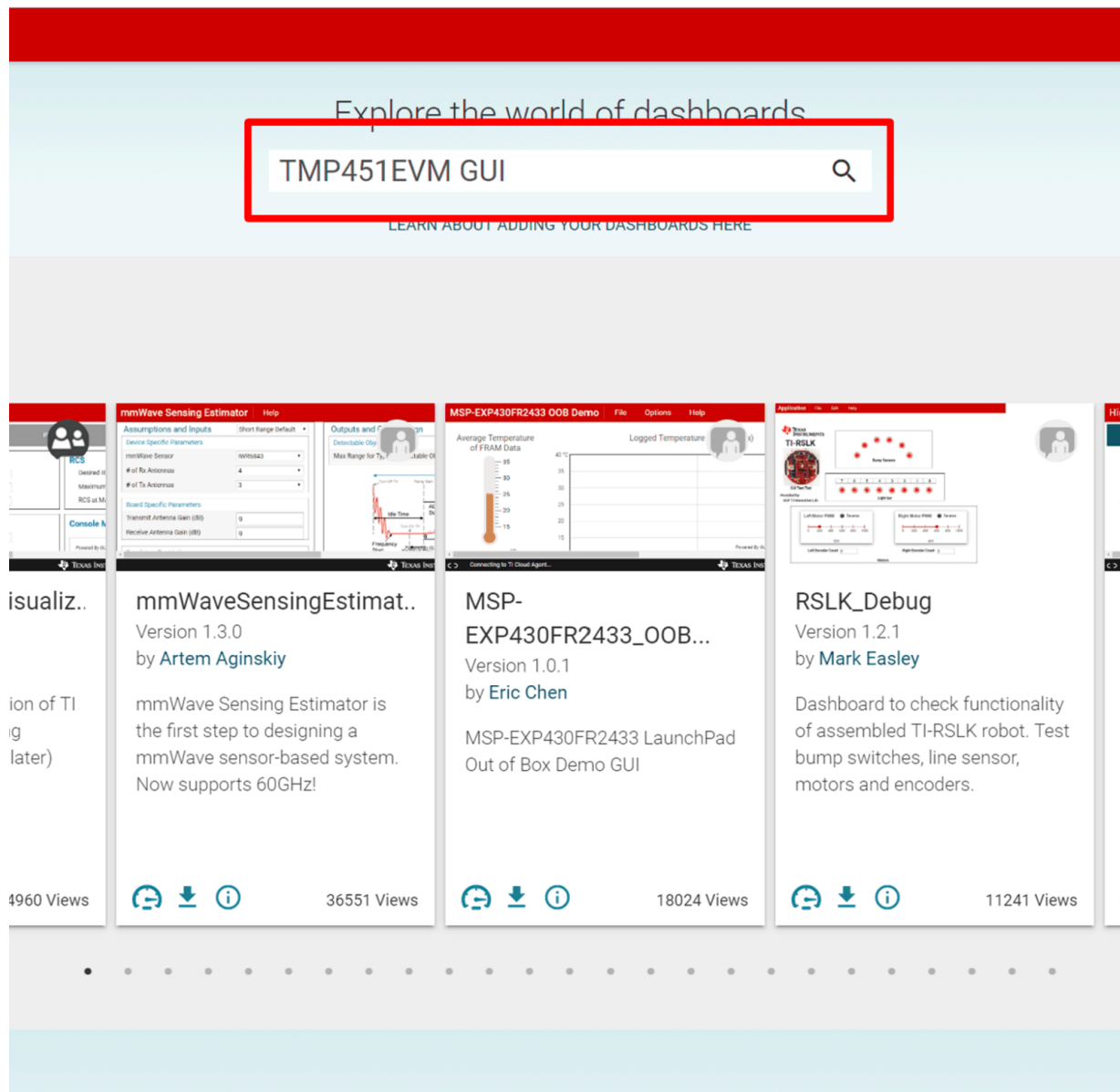

Figure 3-1. Gallery Home Page

Click on the TMP451EVM GUI icon. Users may be prompted to download and install the browser extension for the Firefox or Chrome and TI Cloud Agent Application for the first time. Click on Agree and Proceed. After this the TMP451GUI should launch in your browser window.

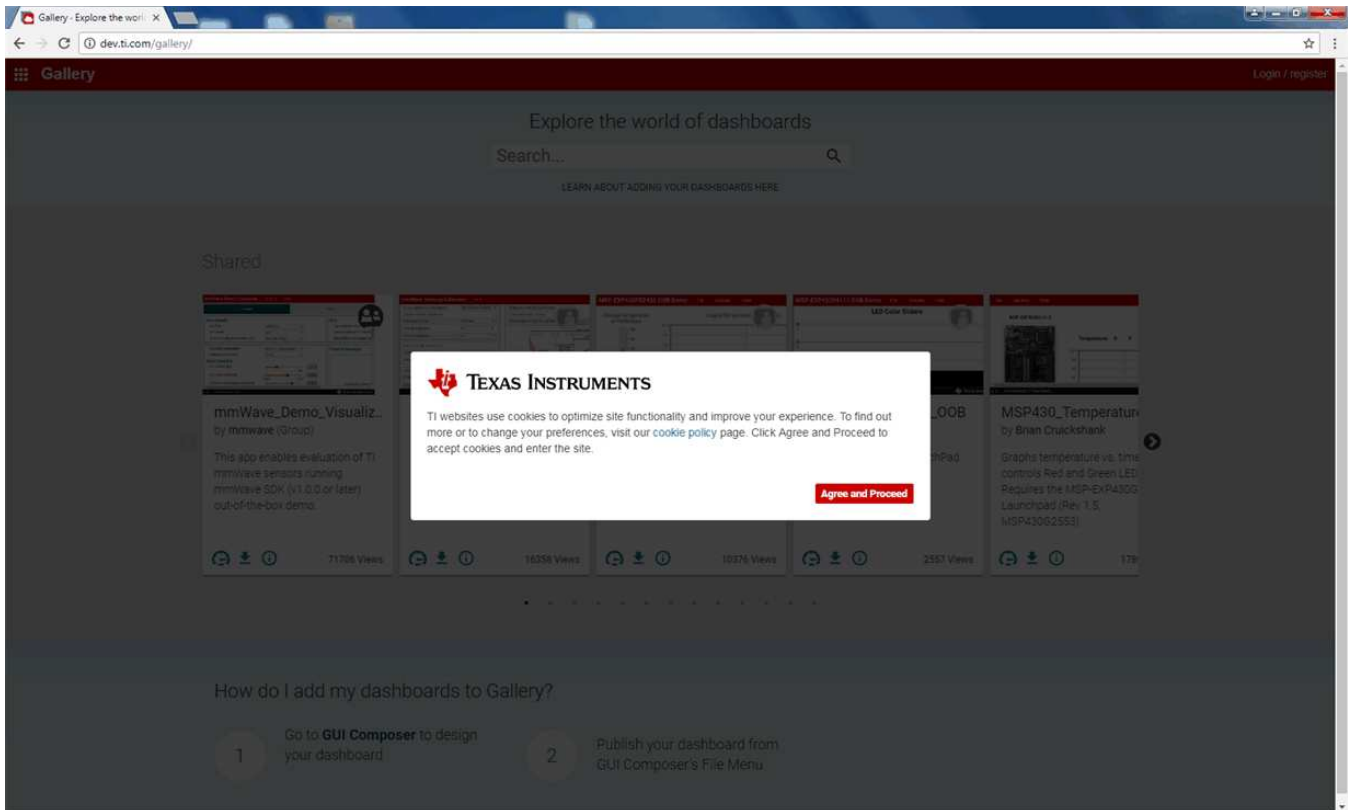

Figure 3-2. Cookies Agreement

3.1.2 Running GUI on Desktop

In the TMP451EVM GUI icon, click on the download icon to download the TMP451EVM_GUI_installer_win.zip. A pop-up screen appears, and select the desired platform to install into your local machine as shown in [Figure 3-3](#)

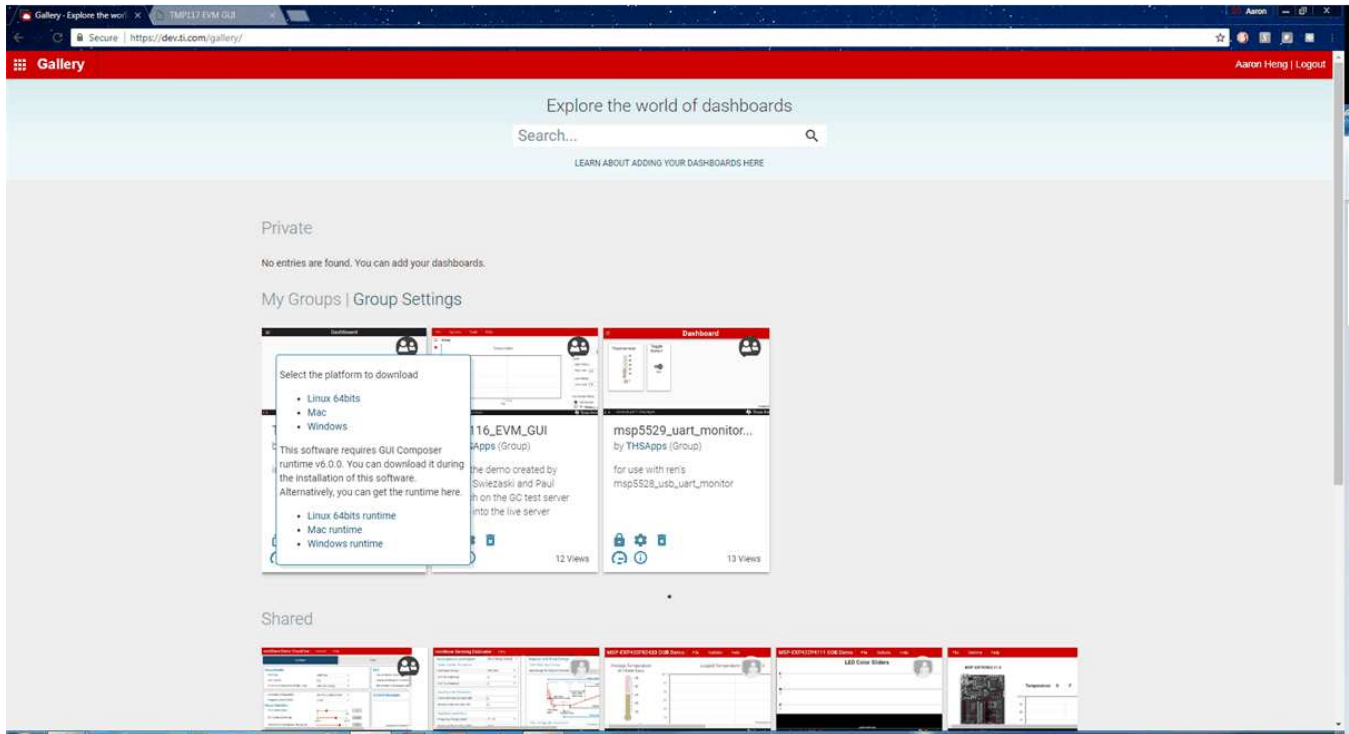

Figure 3-3. TMP451EVM GUI Download From the Gallery

Unzip the downloaded file into a known directory, and run the “TMP451EVM_GUI-1.0.0.setup-win_7.2.0.exe” file located in [Unzipped location]. The EVM software installer then begins the installation process.

Follow the on-screen instructions by clicking the “Next” button to install the GUI Composer runtime engine. If it is the first time installation, the TMP451EVM GUI requires GUI Composer runtime engine v7.2 in order to properly operate.



Figure 3-4. GUI Composer Runtime Wizard

Read through the License Agreement and click the checkbox if you agree and then click "Next".

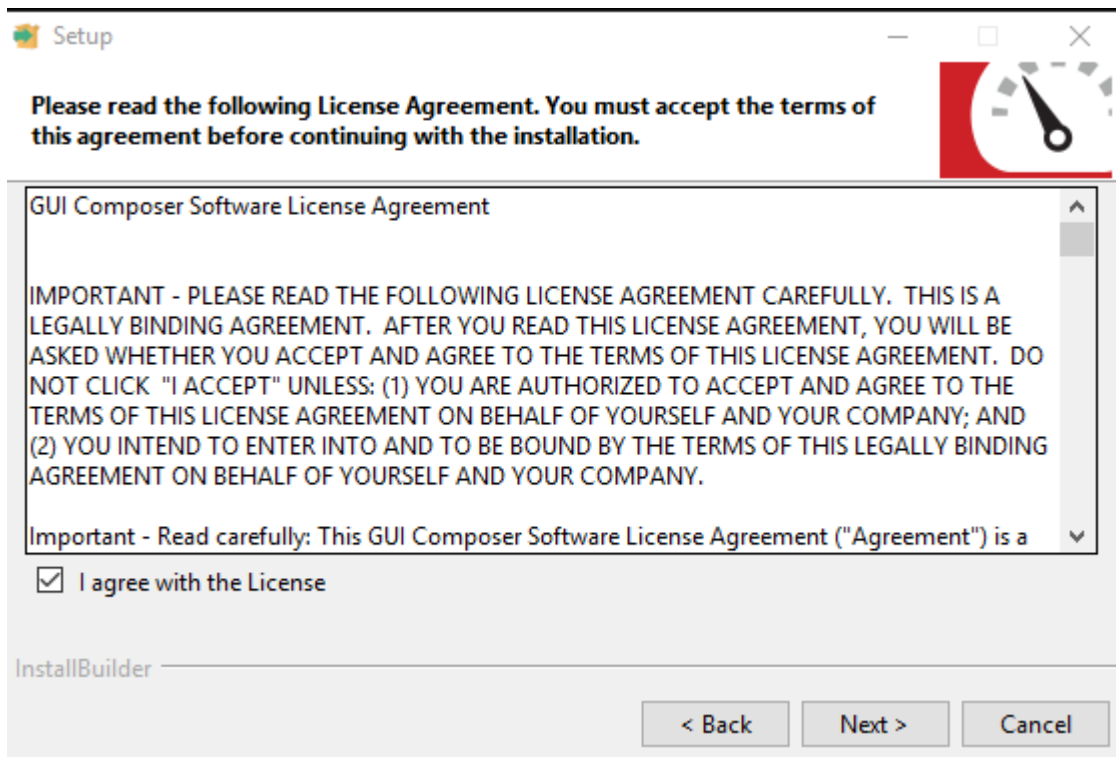

Figure 3-5. TMP451EVM GUI License Agreement

Click on the "Next" button to accept the default installation directory. Installation takes some time to complete.

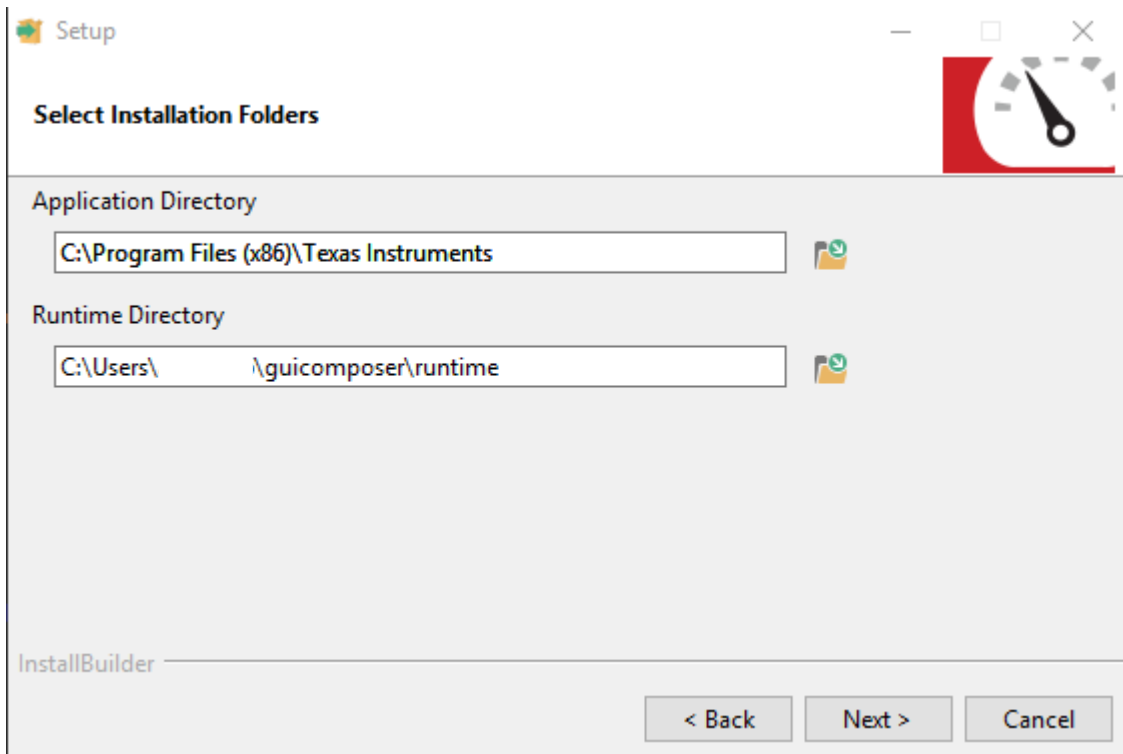

Figure 3-6. GUI Composer Installation Directory

Click "Next" to start installation.

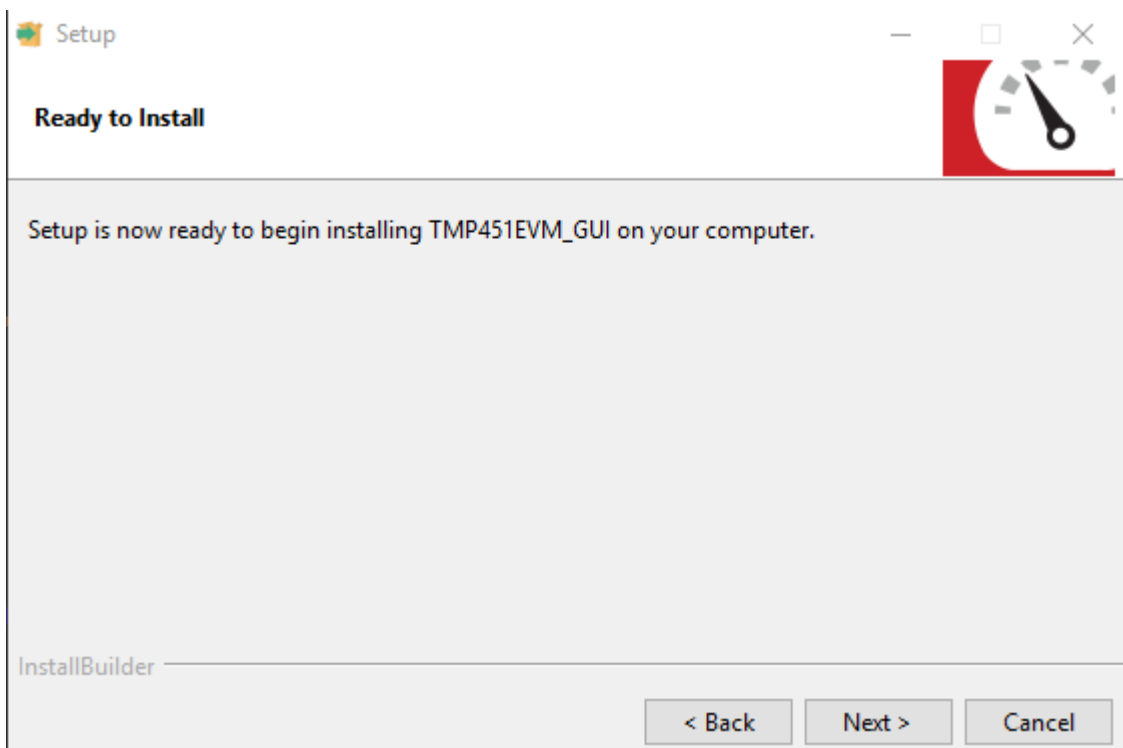

Figure 3-7. Ready to Install

The TMP451EVM GUI will start to install as shown in [Figure 3-8](#).

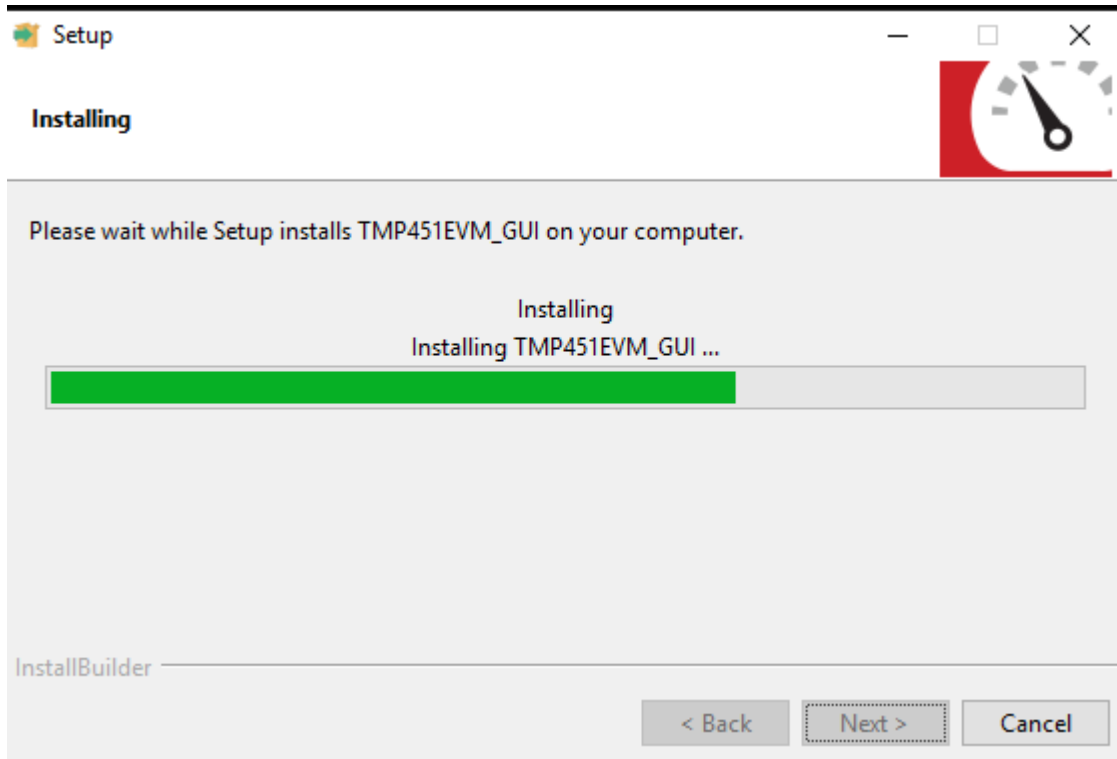

Figure 3-8. Installing GUI Composer Runtime

After installation, click "Finish".

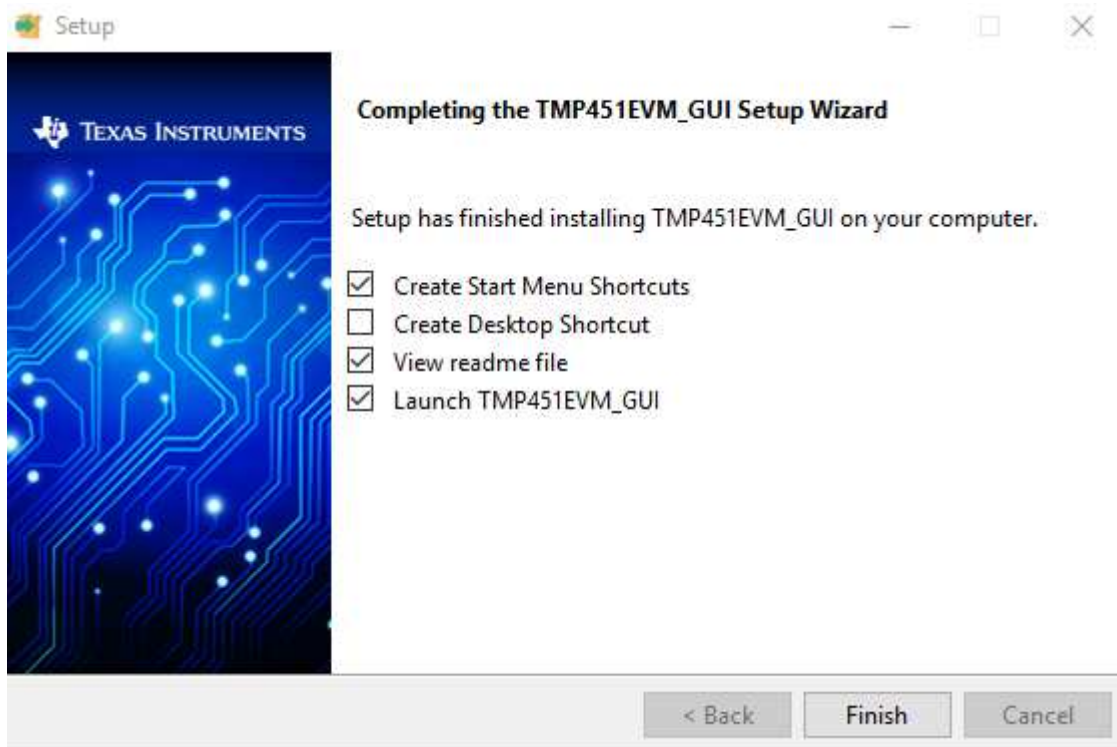

Figure 3-9. TMP451EVM Installation Finish

Read the readme file and close it out after you are done. If you choose to Launch TMP451_GUI it should launch shortly after closing the readme file.

3.2 Using the TMP451EVM Software

3.2.1 Launching and Running the Software

The TMP451EVM GUI can be run from TI Cloud repository <http://dev.ti.com/gallery/> through either the Firefox or Chrome browser or from the Windows desktop offline.

Connect the TMP451EVM to a USB port on a PC as shown in [Figure 2-2](#).

Launch the TMP451EVM software by clicking on the TMP451EVM GUI icon in the Gallery or launching the offline app from windows. The TMP451EVM GUI should automatically initialize and connect to the HID port. A successful connection will show “HARDWARE CONNECTED” on the bottom of the GUI status indicator. If there is a connection problem, verify if the TMP451EVM has an established connection with the PC. A fail connection if the status indicator shows as “HARDWARE NOT CONNECTED”.

3.2.2 Home Tab

When the TMP451EVM GUI is launched, the Home tab will be selected and shown by default. From this page you can navigate to any one of the other 5 tabs. On the left you will see the tab bar that will be available on every tab in the GUI. Clicking on a tab icon will bring you to the respective tab. On the bottom you will see the same list of icons with a short description of each of the tabs. Similarly to the tab bar icons these icons will also bring you to the respective tab.

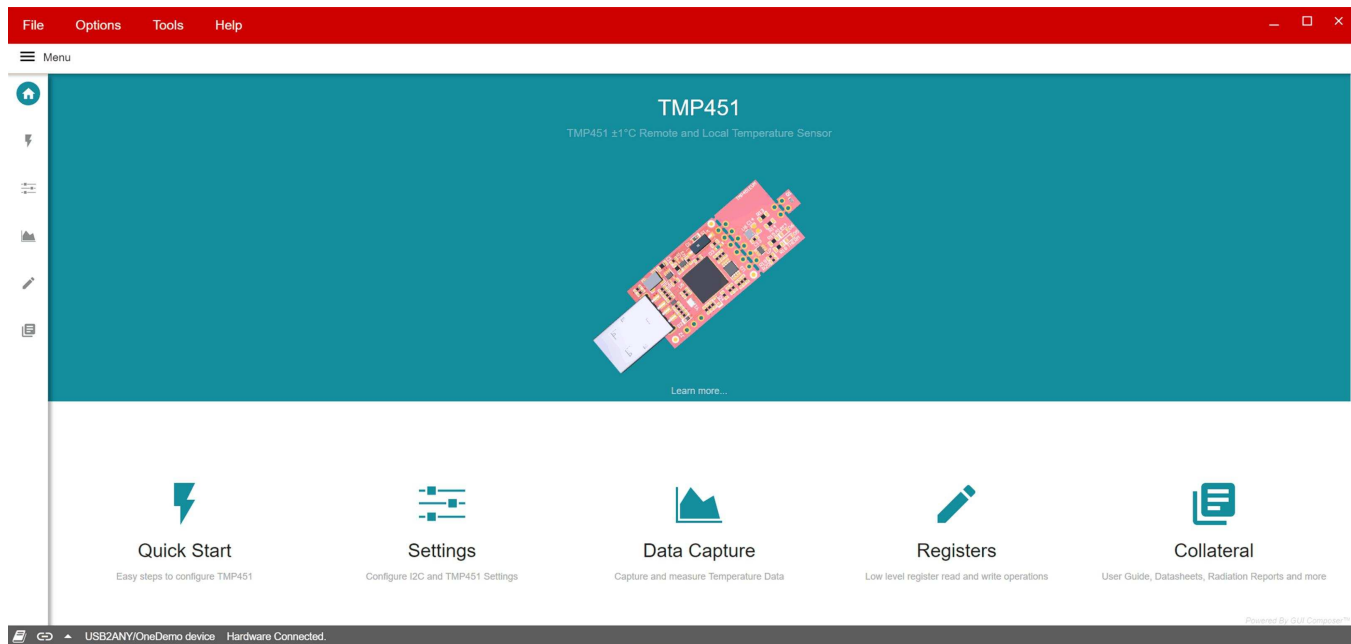

Figure 3-10. TMP451EVM Home Tab

3.2.3 Quick Start Tab

The Quick Start Tab is used to guide you through the basic settings of the TMP451EVM. It will start with a choice of either using default settings or to be guided through the set up. Choosing to use default settings will take you straight to the Data Capture tab. After choosing default settings you can always go back to the Quick Start Tab and choose to be guided through the set up or change the device settings in the Basic Settings Tab.

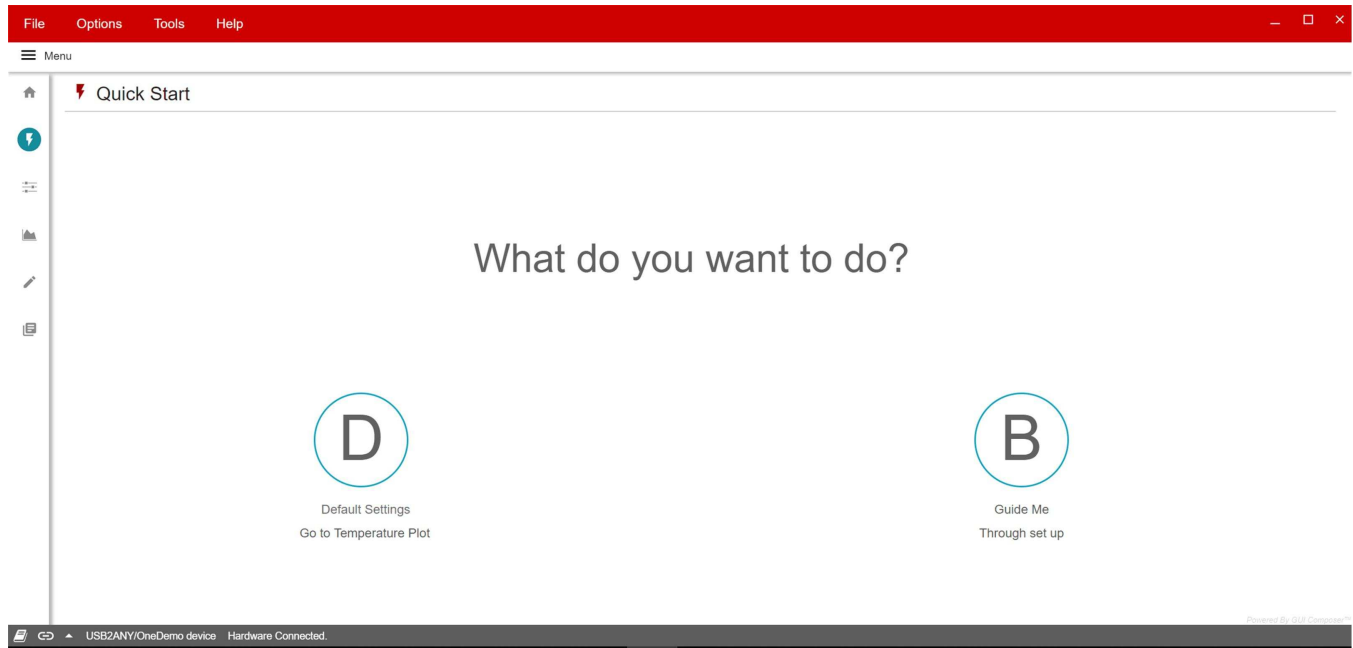

Figure 3-11. TMP451EVM Quick Start Tab

If you choose the set-up guide, you will see a page that will make sure the TMP451EVM is connected correctly. If it is connected correctly, click the "YES" button and a list of high-level settings that you can configure will appear as shown in [Figure 3-13](#).

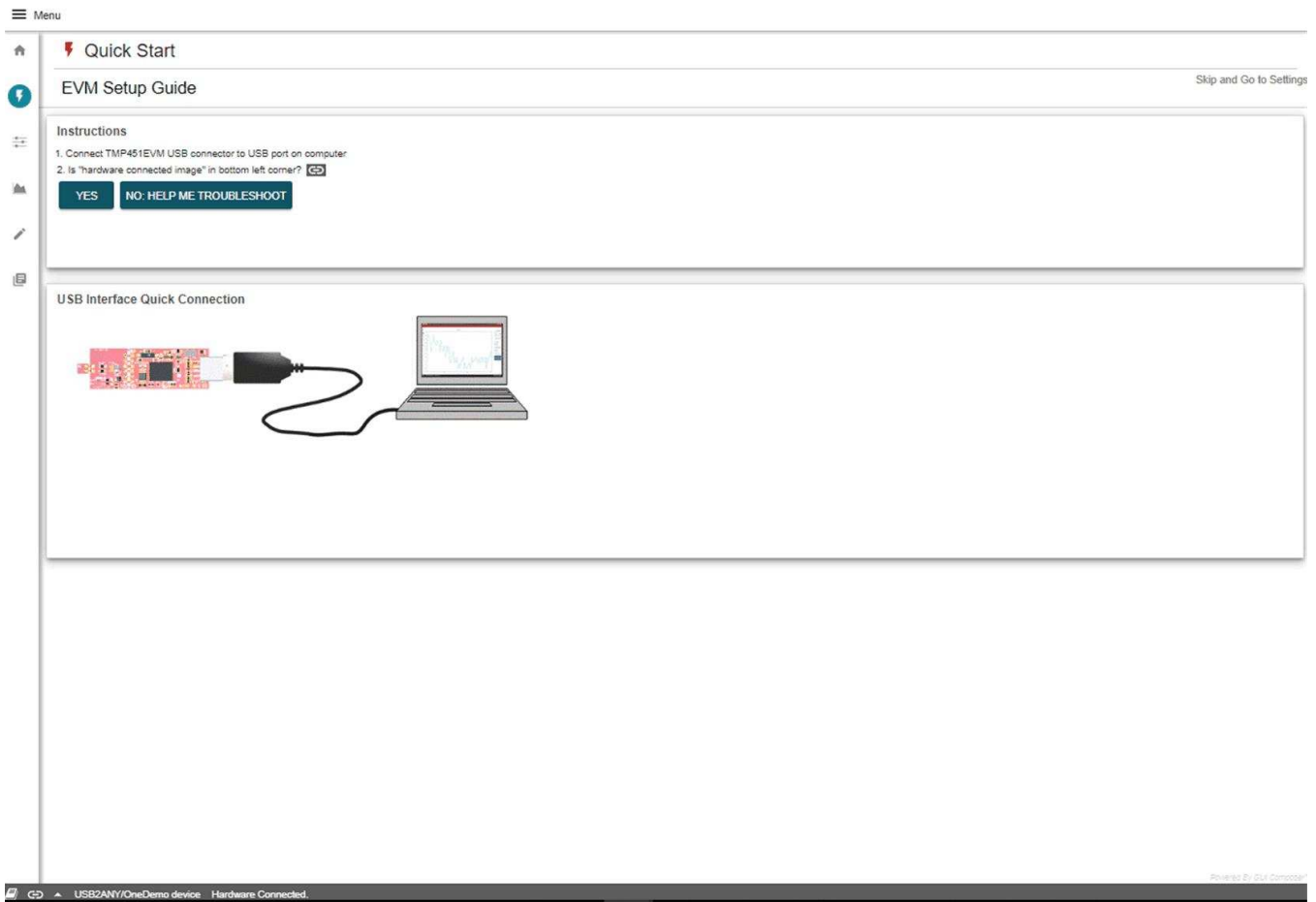

Figure 3-12. Quick Start Connection Check

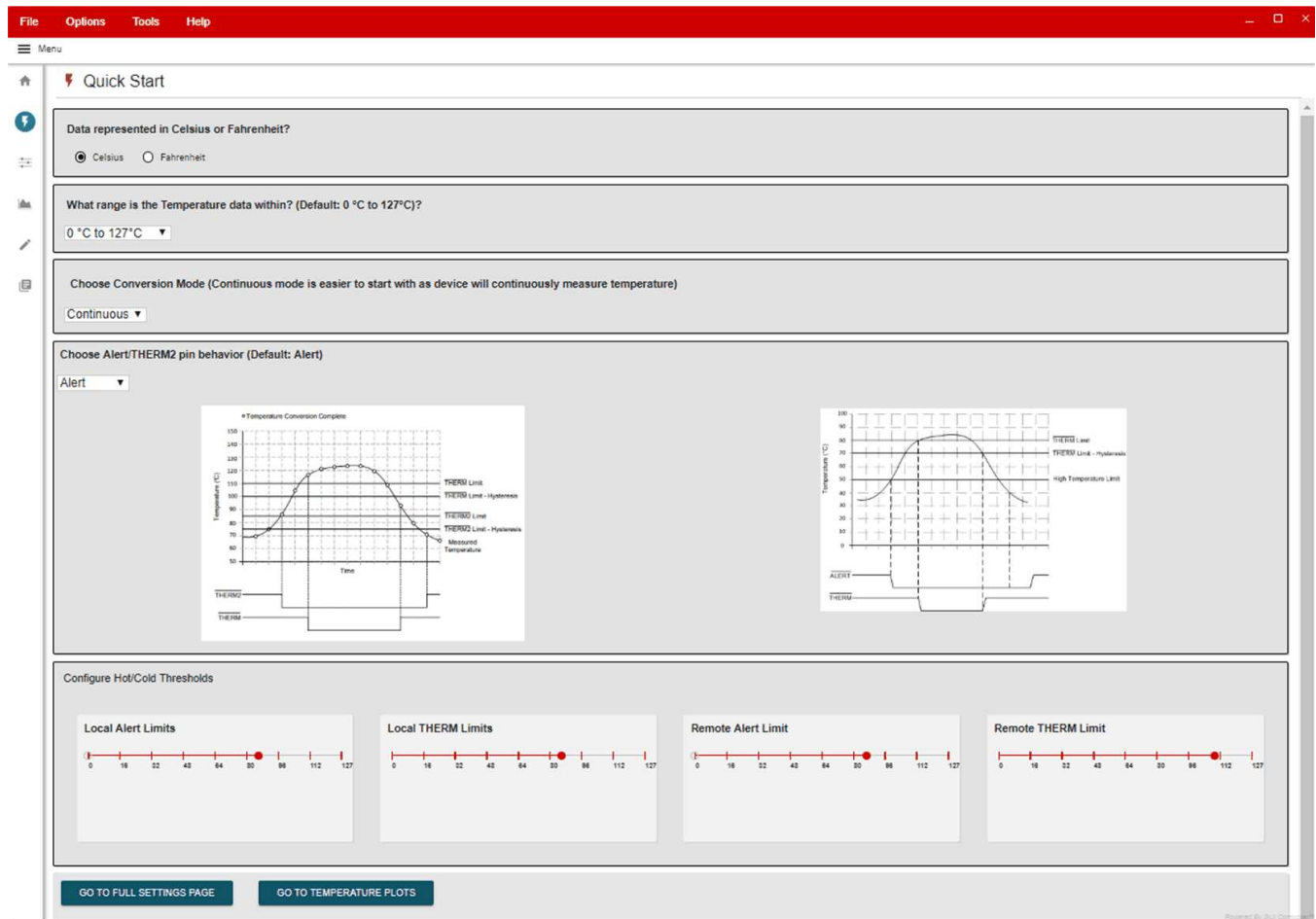

Figure 3-13. Quick Start Guide

At the bottom of these settings you will see a choice to go to the Basic Settings tab where a more extensive list of settings will be, or go to the Data Capture tab.

3.2.4 Basic Settings Tab

The Basic Settings tab is where all the device settings along with I2C settings are configured.

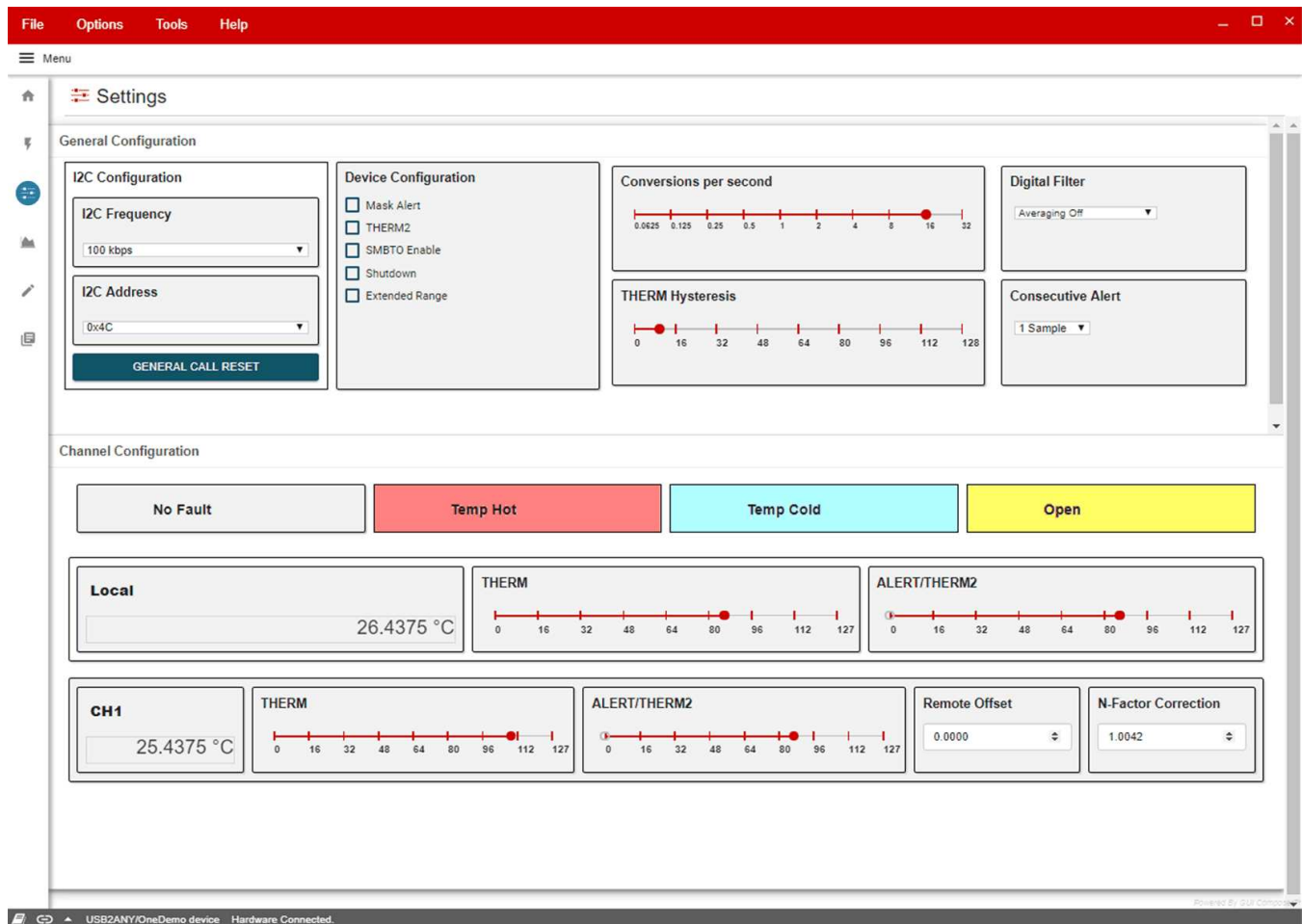

Figure 3-14. TMP451EVM Basic Settings Tab

3.2.4.1 I2C Configuration

I2C Frequency: this drop-down sets the I2C clock frequency to either 100 kbps or 400 kbps

I2C Address: this displays the I2C address of the TMP451

General Call Reset: clicking this push button will send a General Call Reset of the device

3.2.4.2 Device Configuration

Mask Alert: setting this checkbox masks the ALERT pin output

THERM2: setting this checkbox configures pin 6 to the THERM2 output

SMBTO Enable setting this checkbox will enable the SMBus time-out function

Shutdown: setting this checkbox will place the device into shutdown mode

Extended Range: setting this checkbox will configure the TMP451 for the extended measurement range

Conversion per second: this slider will set how many temperature conversions the TMP451 will perform per second

THERM Hysteresis: this slider will set the THERM hysteresis value

Digital Filter: this drop down will set the digital filter to average either 4 or 8 samples or turn off the filter
Consecutive Alert: this drop-down will set the number of limit violations before the ALERT pin is tripped.

3.2.4.3 Channel Configuration

The TMP451EVM has a local channel and one remote channel. In the Channel Configuration section is where the settings that are specific to a channel are configured.

3.2.4.3.1 Local

Temperature Reading: displays the temperature of the channel

THERM Limit: this slider sets the THERM limit threshold

ALERT_THERM2 Limit: this slider sets the High and Low ALERT limit threshold. When pin 6 is configured to THERM2 this will set the THERM2 limit threshold.

3.2.4.3.2 Remote

Temperature Reading: displays the temperature of the channel

THERM Limit: this slider sets the THERM limit threshold

ALERT_THERM2 Limit: this slider sets the High and Low ALERT limit threshold. When pin 6 is configured to THERM2 this will set the THERM2 limit threshold.

Remote Offset: this number spinner will set the temperature offset of the remote channel temperature reading

N-Factor Correction: this number spinner is used to adjust for the N-factor of the remote BJT. Set this spinner to the N-factor of the remote BJT that is connected to the TMP451EVM

3.2.5 Data Capture Tab

The Data Capture Tab is where the temperature readings as well as the set temperature thresholds will be graphed.



Figure 3-15. TMP451EVM Data Capture Tab

In the bottom left of the Data Capture tab is a short list of device configurations that are also found on the Basic Settings tab with the addition of the "SEND ONE SHOT" button. This button will enable only when the conversion mode is set to "Shutdown" When this button is clicked a One Shot command will be sent to the device and a single temperature conversion will be done.

In the bottom right of the Data Capture tab, there are GUI settings. These settings do not configure the TMP451EVM but changes how the GUI will handle the data collected from the TMP451EVM.

Temperature Scale: this radio button group sets the units the temperature information is displayed

Show Threshold Sliders: setting this check box will show the threshold sliders to the right of the graph as well as displays for the temperature readings

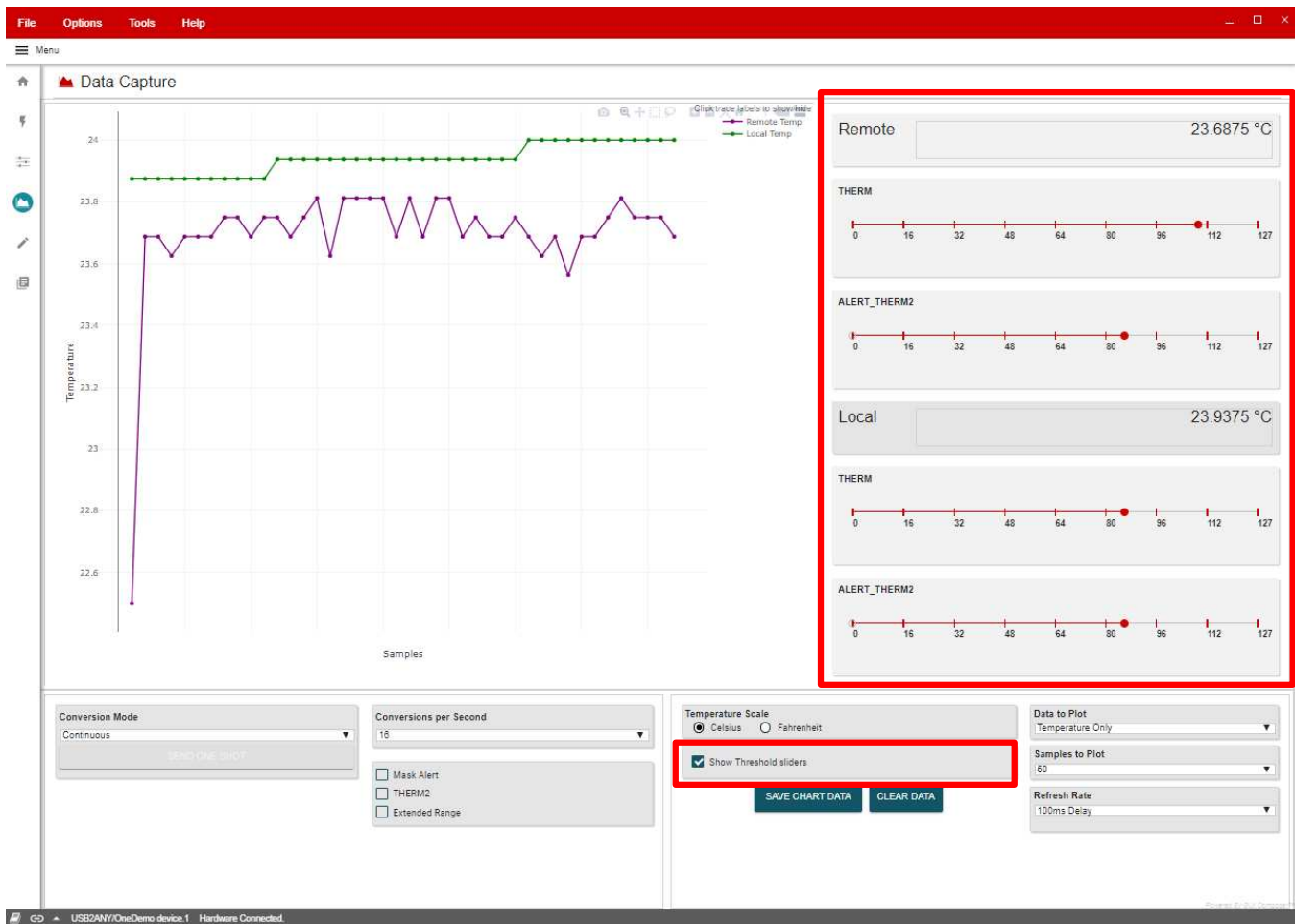

Figure 3-16. Threshold Sliders

Graph: this is where the temperature data and thresholds are plotted. Clicking on traces in the legend in the top right will hide/show different traces. Hovering over the graph will display different point information and other features icons will appear in the top right.

Data to Plot: this drop-down determines which data is plotted on the graph

Samples to Plot: this drop-down sets how many samples are plotted on the graph

Refresh Rate: this drop-down sets the desired time frame to fetch the register data. This is directly tied to the Auto-read drop-down on the Register Tab

Save Data: clicking this button will save the plotted data into an .csv file

Clear Data: clicking this button will clear all the data that is plotted on the graph

3.2.6 Register Tab

The Register Map page shown in [Figure 3-17](#) allows low-level access to all the I2C registers of the TMP451 device. Clicking on the question mark to the right of the Register Name will bring up an extraction short version from the datasheet describing that register. Clicking on a specific Register Name will populate the Field View to on the right side of the screen. The Field View describes each bit field within that register. The “Registers” tab provides access to the registers raw data of the TMP451. Changes to the configuration page are mirrored here, and vice versa.

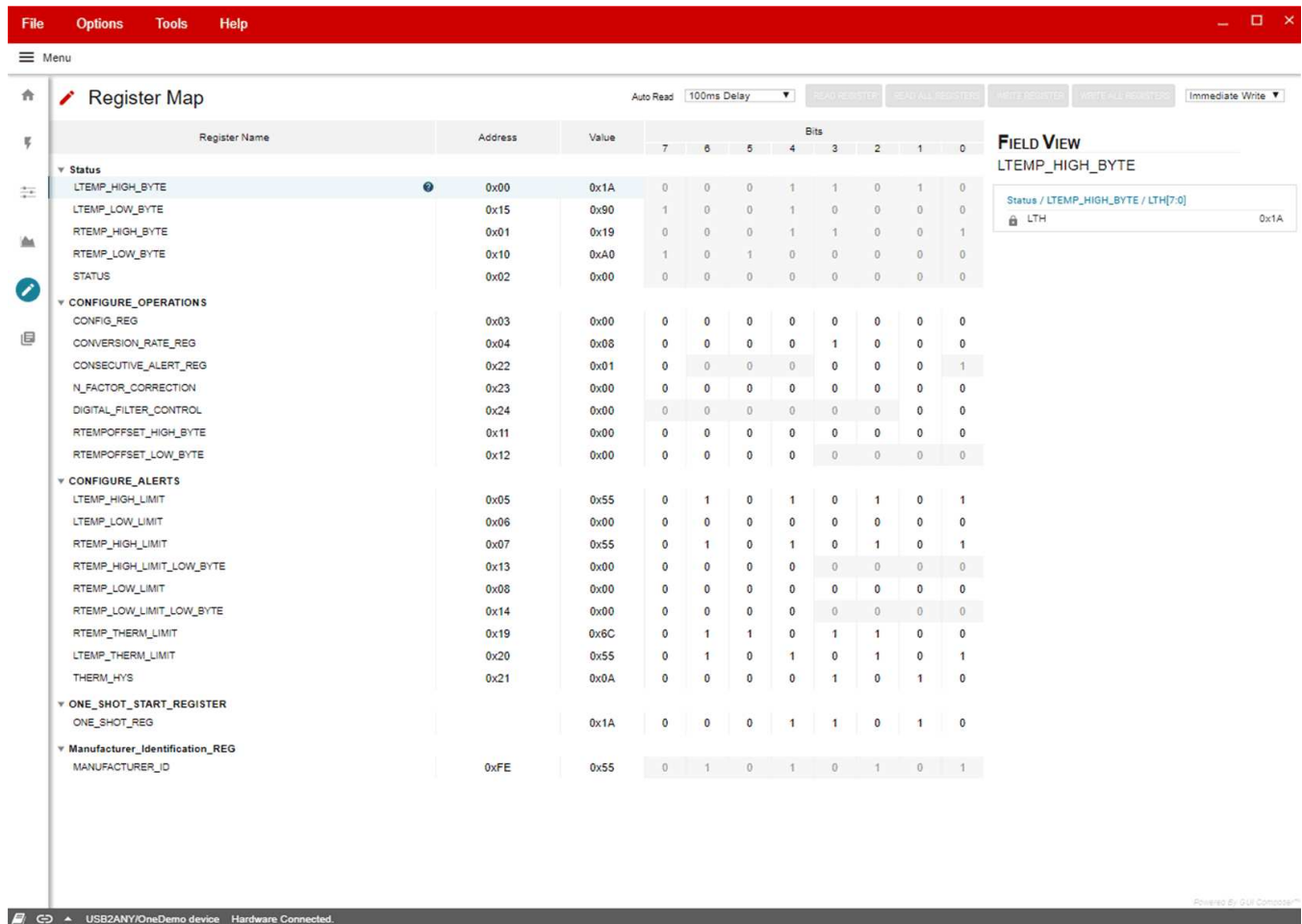

Figure 3-17. TMP451EVM Register Tab

Read Registers: performs a single read for the selected register.

Read All Registers: performs a read for all registers contents.

Auto Read: allows the user to set the desired time frame to fetch the register data.

3.2.7 Collateral

The Collateral Tab as shown in [Figure 3-18](#) contains links to web documents pertinent to the TMP451EVM. The page is divided into four sections: (1) User Guide, (2) Datasheet, (3) Application Notes, and (4) MSP432 Firmware.

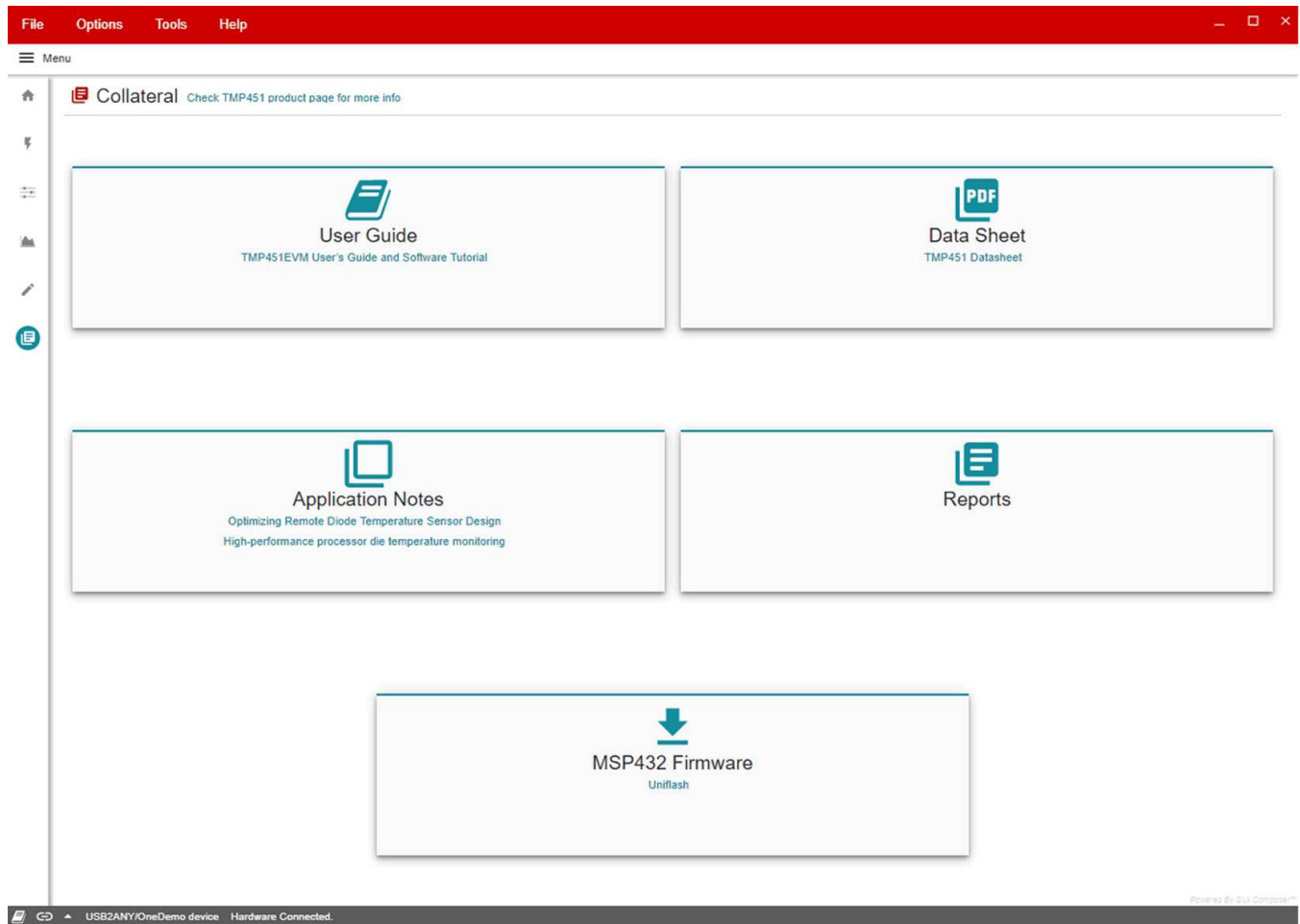

Figure 3-18. TMP451EVM Collateral Tab

TMP451EVM Documentation

This section contains the complete bill of materials, schematic diagram, and layout for the TMP451EVM.

4.1 TMP451EVM Board Schematic

Figure 4-1 shows the board schematic for the TMP451EVM board.

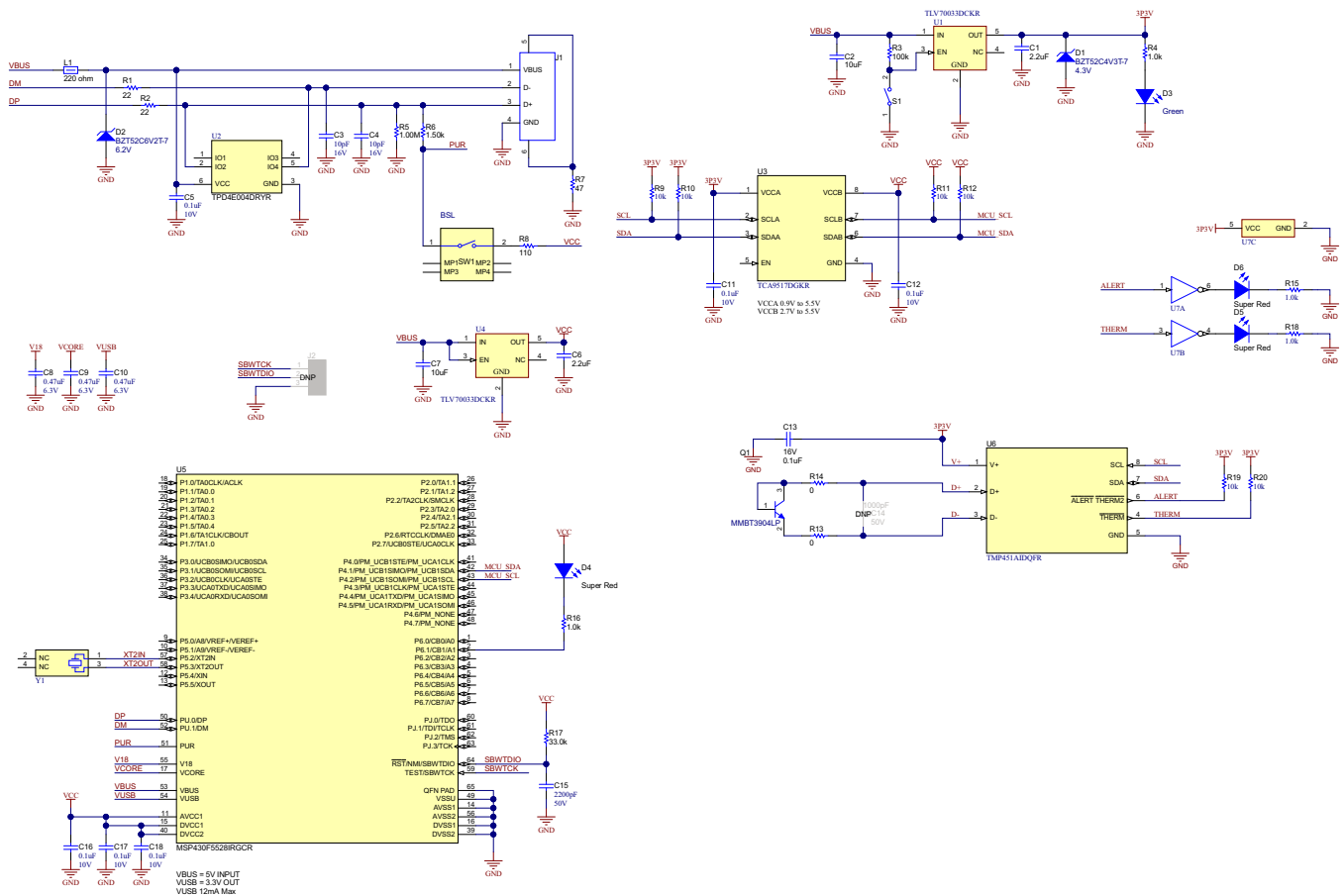

Figure 4-1. TMP451EVM Schematic

4.2 TMP451EVM Board Layout

The figures in this section show the board layout for the TMP451EVM board.

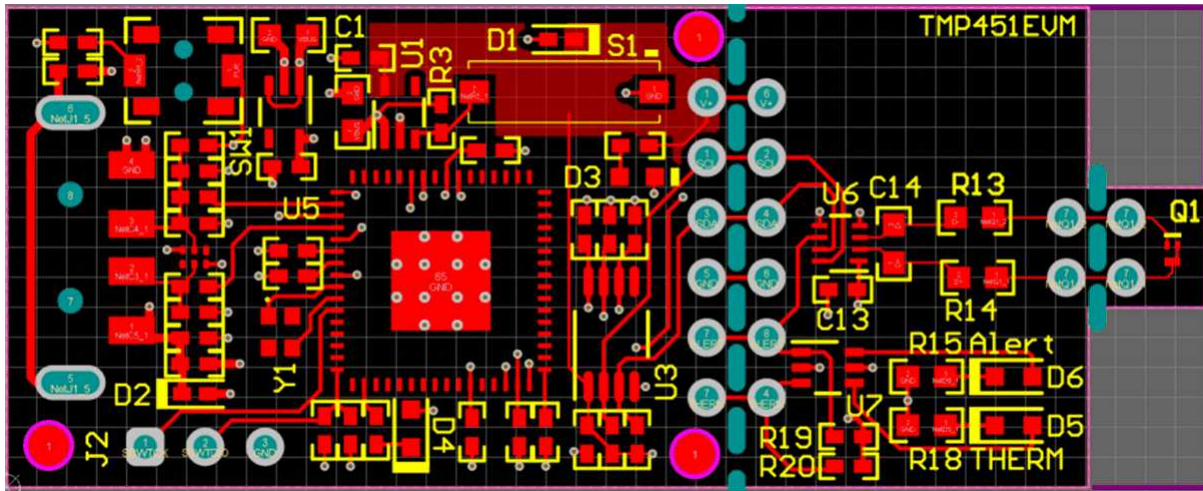

Figure 4-2. Top Assembly Layer

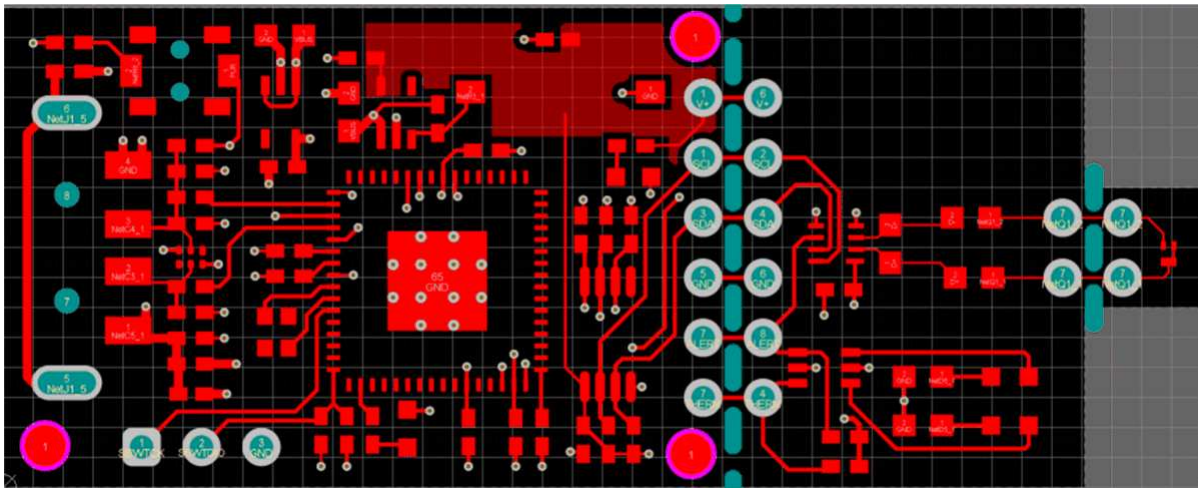

Figure 4-3. Top Routing Layer

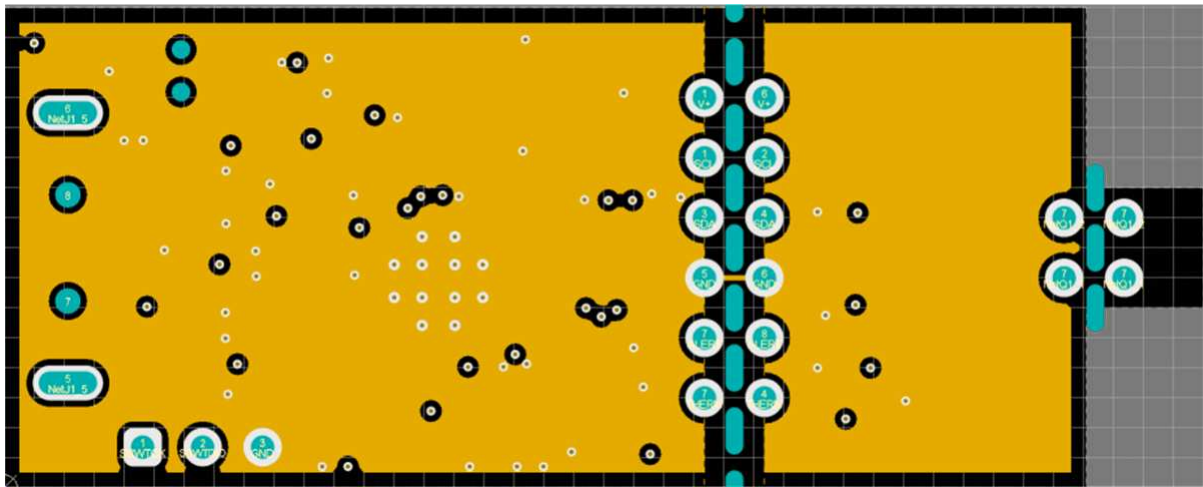

Figure 4-4. Ground Layer Routing

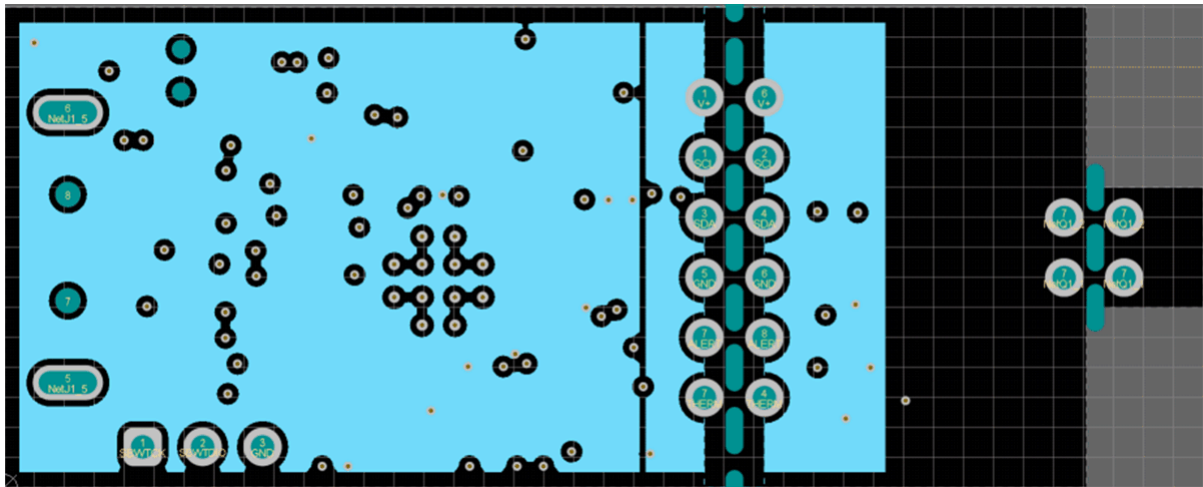

Figure 4-5. Power Layer Routing

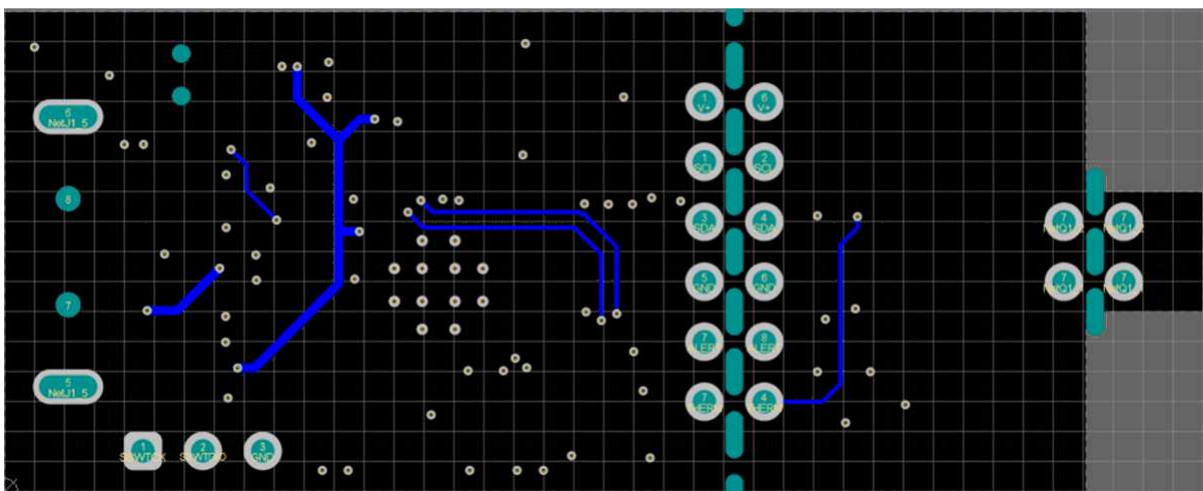

Figure 4-6. Bottom Layer Routing

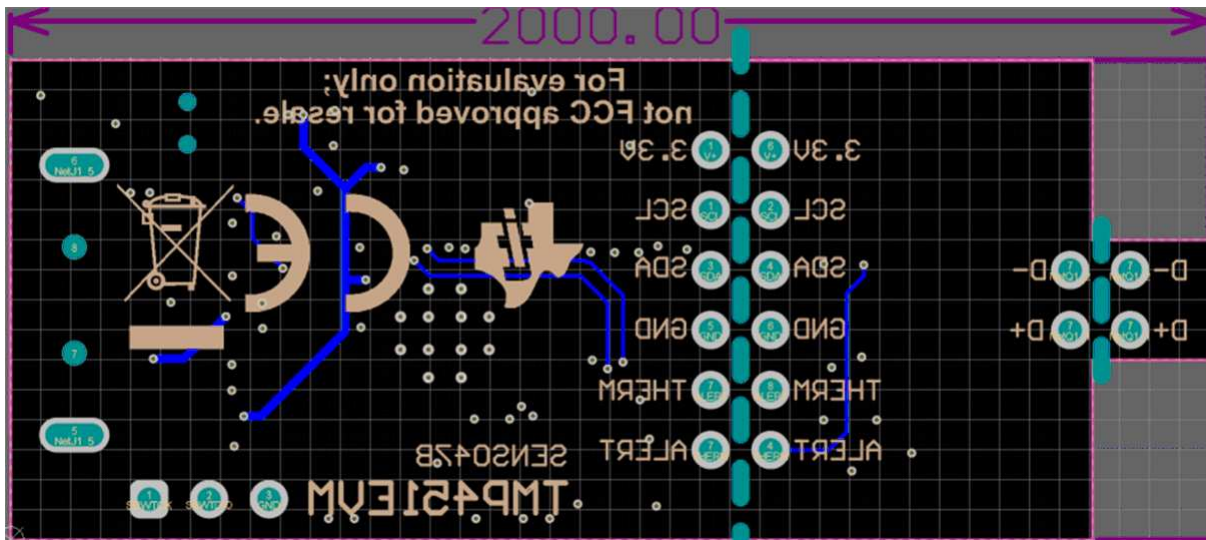

Figure 4-7. Bottom Assembly Layer

4.3 TMP451 Test Board Bill of Materials

Table 4-1 lists the bill of materials for the TMP451EVM Test Board.

Table 4-1. TMP451EVM Bill of Materials (BOM)

DESIGNATOR	QUANTITY	VALUE	DESCRIPTION	PACKAGE REFERENCE	PART NUMBER	MANUFACTURER	ALTERNATE PART NUMBER	ALTERNATE MANUFACTURER
C1, C6	2	2.2uF	CAP, CERM, 2.2 uF, 16 V, +/- 10%, X5R, 0402	0402	GRM155R61C225 KE11D	MuRata		
C2, C7	2	10uF	CAP, CERM, 10 uF, 10 V, +/- 20%, X5R, 0603	0603	C1608X5R1A106M 080AC	TDK		
C3, C4	2	10pF	CAP, CERM, 10 pF, 16 V, +/- 10%, COG, 0402	0402	C0402C100K4GA CTU	Kemet		
C5, C11, C12, C16, C17, C18	6	0.1uF	CAP, CERM, 0.1 uF, 10 V, +/- 10%, X5R, 0402	0402	LMK105BJ104KV-F	Taiyo Yuden		
C8, C9, C10	3	0.47uF	CAP, CERM, 0.47 uF, 6.3 V, +/- 10%, X7R, 0402	0402	JMK105B7474KVH F	Taiyo Yuden		
C13	1	0.1uF	CAP, CERM, 0.1 uF, 16 V, +/- 10%, X7R, 0402	0402	ATC530L104KT16 T	AT Ceramics		
C15	1	2200pF	CAP, CERM, 2200 pF, 50 V, +/- 5%, X7R, 0402	0402	CL05B222JB5NNN C	Samsung Electro-Mechanics		
D1	1	4.3V	Diode, Zener, 4.3 V, 300 mW, SOD-523	SOD-523	BZT52C4V3T-7	Diodes Inc.		
D2	1	6.2V	Diode, Zener, 6.2 V, 300 mW, SOD-523	SOD-523	BZT52C6V2T-7	Diodes Inc.		
D3	1	Green	LED, Green, SMD	LED, GREEN, 0603	SML-LX0603GW-TR	Lumex		
D4, D5, D6	3	Super Red	LED, Super Red, SMD	LED_0603	150060SS75000	Würth Elektronik		
J1	1		Connector, Plug, USB Type A, R/A, Top Mount SMT	USB Type A right angle	48037-1000	Molex		
L1	1	220 ohm	Ferrite Bead, 220 ohm @ 100 MHz, 0.45 A, 0402	0402	BLM15AG221SN1 D	MuRata		
Q1	1	40 V	Transistor, NPN, 40 V, 0.2 A, 3-UDFN	3-UDFN	MMBT3904LP	Diodes Inc.		
R1, R2	2	22	RES, 22, 5%, 0.1 W, AEC-Q200 Grade 0, 0402	0402	ERJ-2GEJ220X	Panasonic		
R3	1	100k	RES, 100 k, 5%, 0.1 W, AEC-Q200 Grade 0, 0402	0402	ERJ-2GEJ104X	Panasonic		
R4, R16	2	1.0k	RES, 1.0 k, 5%, 0.1 W, AEC-Q200 Grade 0, 0402	0402	ERJ-2GEJ102X	Panasonic		
R5	1	1.00Meg	RES, 1.00 M, 1%, 0.063 W, AEC-Q200 Grade 0, 0402	0402	RMCF0402FT1M0 0	Stackpole Electronics Inc		

Table 4-1. TMP451EVM Bill of Materials (BOM) (continued)

DESIGNATOR	QUANTITY	VALUE	DESCRIPTION	PACKAGE REFERENCE	PART NUMBER	MANUFACTURER	ALTERNATE PART NUMBER	ALTERNATE MANUFACTURER
R6	1	1.50k	RES, 1.50 k, 1%, 0.063 W, AEC-Q200 Grade 0, 0402	0402	RMCF0402FT1K50	Stackpole Electronics Inc		
R7	1	47	RES, 47, 5%, 0.1 W, AEC-Q200 Grade 0, 0402	0402	ERJ-2GEJ470X	Panasonic		
R8	1	110	RES, 110, 1%, 0.1 W, AEC-Q200 Grade 0, 0402	0402	ERJ-2RKF1100X	Panasonic		
R9, R10, R11, R12, R19, R20	6	10k	RES, 10 k, 5%, 0.1 W, AEC-Q200 Grade 0, 0402	0402	ERJ-2GEJ103X	Panasonic		
R13, R14	2	0	RES, 0, 0%, 0.25 W, AEC-Q200 Grade 0, 0603	0603	RCS06030000Z0EA	Vishay-Dale		
R15, R18	2	1.0k	RES, 1.0 k, 5%, 0.1 W, 0603	0603	RC0603JR-071KL	Yageo		
R17	1	33.0k	RES, 33.0 k, 1%, 0.063 W, 0402	0402	RC0402FR-0733KL	Yageo America		
S1	1		Switch, Slide, SPST, Top Slide, SMT	Switch, Single Top Slide, 2.5x8x2.5mm	CHS-01TB	Copal Electronics		
SW1	1		Switch, SPST-NO, Off-Mom, 0.05A, 12VDC, SMD	3.9x2.9mm	PTS820 J20M SMTR LFS	C&K Components		
U1, U4	2		Single Output LDO, 200 mA, Fixed 3.3 V Output, 2 to 5.5 V Input, with Low IQ, 5-pin SC70 (DCK), -40 to 125 degC, Green (RoHS & no Sb/Br)	DCK0005A	TLV70033DCKR	Texas Instruments		
U2	1		4-Channel ESD Protection Array for High-Speed Data Interfaces, DRY0006A (USON-6)	DRY0006A	TPD4E004DRYR	Texas Instruments		
U3	1		Level-Shifting I2C Bus Repeater, DGK0008A (VSSOP-8)	DGK0008A	TCA9517DGKR	Texas Instruments		Texas Instruments
U5	1		16-Bit Ultra-Low-Power Microcontroller, 128KB Flash, 8KB RAM, USB, 12Bit ADC, 2 USCs, 32Bit HW MPY, RGC0064B (VQFN-64)	RGC0064B	MSP430F5528IRGCR	Texas Instruments		
U6	1		1.7V-Capable Remote and Local Temp Sensor with Auto Beta, N-Factor, Filter, and Series-R Correction, DQF0008A (WSON-8)	DQF0008A	TMP451AIDQFR	Texas Instruments	TMP451AIDQFT	Texas Instruments
U7	1		Dual Inverter, DCK0006A (SOT-SC70-6)	DCK0006A	SN74LVC2G04DCKR	Texas Instruments		

Table 4-1. TMP451EVM Bill of Materials (BOM) (continued)

DESIGNATOR	QUANTITY	VALUE	DESCRIPTION	PACKAGE REFERENCE	PART NUMBER	MANUFACTURER	ALTERNATE PART NUMBER	ALTERNATE MANUFACTURER
Y1	1		Crystal, 24 MHz, SMD	2x1.6mm	XRCGB24M000F2 P00R0	MuRata		
C14	0	1000pF	CAP, CERM, 1000 pF, 50 V, +/- 5%, C0G/NP0, 0603	0603	C0603C102J5GAC TU	Kemet		
J2	0		Header, 100mil, 3x1, Gold, TH	3x1 Header	TSW-103-07-G-S	Samtec		

Revision History

NOTE: Page numbers for previous revisions may differ from page numbers in the current version.

Changes from Original (June 2013) to A Revision	Page
• Changed <i>Contents of TMP451EVM Kit</i> table.....	6
• Updated graphics and screenshots of hardware and software changes	6
• Combined <i>TMP451EVM Hardware Setup</i> and <i>TMP451EVM Hardware Overview</i> sections	7
• Combined <i>TMP451EVM Software Setup</i> and <i>TMP451EVM Software Overview</i> sections	9
• Changed <i>Using the TMP451EVM Software</i> section	17
• Changed <i>TMP451EVM Board Schematic</i> section.....	27
• Changed <i>TMP451EVM Board Layout</i> section	28
• Changed <i>TMP451EVM Bill of Materials (BOM)</i> table	31

IMPORTANT NOTICE AND DISCLAIMER

TI PROVIDES TECHNICAL AND RELIABILITY DATA (INCLUDING DATASHEETS), DESIGN RESOURCES (INCLUDING REFERENCE DESIGNS), APPLICATION OR OTHER DESIGN ADVICE, WEB TOOLS, SAFETY INFORMATION, AND OTHER RESOURCES "AS IS" AND WITH ALL FAULTS, AND DISCLAIMS ALL WARRANTIES, EXPRESS AND IMPLIED, INCLUDING WITHOUT LIMITATION ANY IMPLIED WARRANTIES OF MERCHANTABILITY, FITNESS FOR A PARTICULAR PURPOSE OR NON-INFRINGEMENT OF THIRD PARTY INTELLECTUAL PROPERTY RIGHTS.

These resources are intended for skilled developers designing with TI products. You are solely responsible for (1) selecting the appropriate TI products for your application, (2) designing, validating and testing your application, and (3) ensuring your application meets applicable standards, and any other safety, security, or other requirements. These resources are subject to change without notice. TI grants you permission to use these resources only for development of an application that uses the TI products described in the resource. Other reproduction and display of these resources is prohibited. No license is granted to any other TI intellectual property right or to any third party intellectual property right. TI disclaims responsibility for, and you will fully indemnify TI and its representatives against, any claims, damages, costs, losses, and liabilities arising out of your use of these resources.

TI's products are provided subject to TI's Terms of Sale (www.ti.com/legal/termsofsale.html) or other applicable terms available either on ti.com or provided in conjunction with such TI products. TI's provision of these resources does not expand or otherwise alter TI's applicable warranties or warranty disclaimers for TI products.

Mailing Address: Texas Instruments, Post Office Box 655303, Dallas, Texas 75265
Copyright © 2019, Texas Instruments Incorporated