

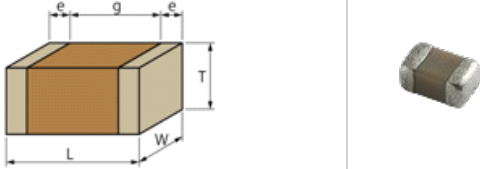

< List of part numbers with package codes >
 GR355DD72W224KW01L , GR355DD72W224KW01K

Shape



| | |
|---------------------------------------|---------------|
| L size | 5.7 ±0.4mm |
| W size | 5.0 ±0.4mm |
| T size | 2.0 +0/-0.3mm |
| External terminal width e | 0.3mm min. |
| Distance between external terminals g | 3.0mm min. |
| Size code in inch(mm) | 2220 (5750M) |

Notes

Large Capacitance and High Allowable Ripple Current

References

| Packaging | Specifications | Minimum quantity |
|-----------|------------------------|------------------|
| L | φ180mm Embossed taping | 1000 |
| K | φ330mm Embossed taping | 4000 |

| Mass (typ.) | |
|-------------|-------|
| 1 piece | 290mg |
| φ180mm Reel | 347g |

Specifications

| | |
|--|--------------|
| Capacitance | 0.22μF ±10% |
| Rated voltage | 450Vdc |
| Temperature characteristics (complied standard) | X7T(EIA) |
| Capacitance change rate | +22.0/-33.0% |
| Temperature range of temperature characteristics | -55 to 125°C |
| Operating temperature range | -55 to 125°C |

Attention

- 1.This datasheet is downloaded from the website of Murata Manufacturing Co., Ltd. Therefore, it's specifications are subject to change or our products in it may be discontinued without advance notice. Please check with our sales representatives or product engineers before ordering.
- 2.This datasheet has only typical specifications because there is no space for detailed specifications. Therefore, please review our product specifications or consult the approval sheet for product specifications before ordering.

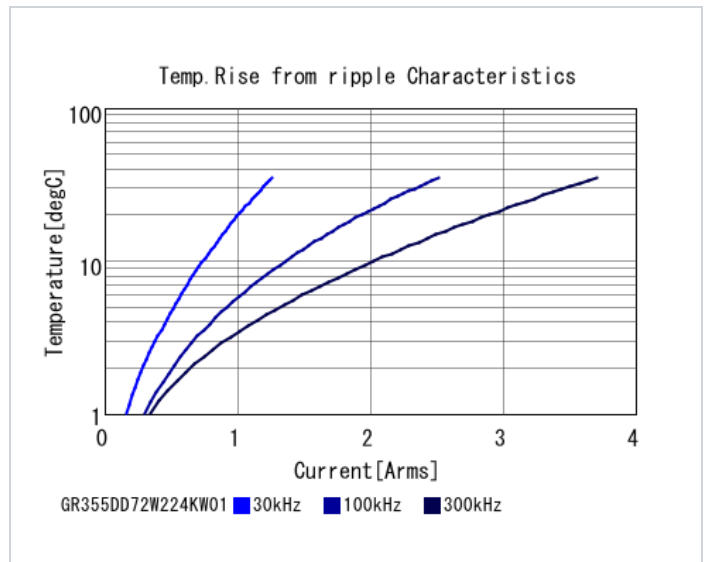
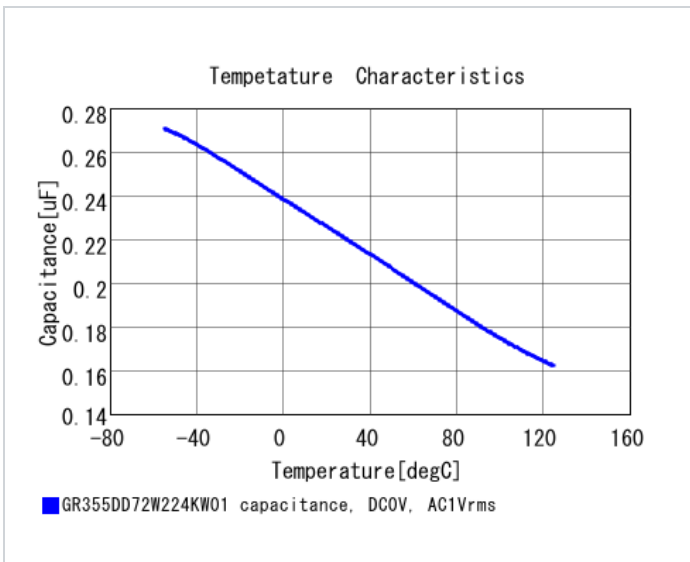
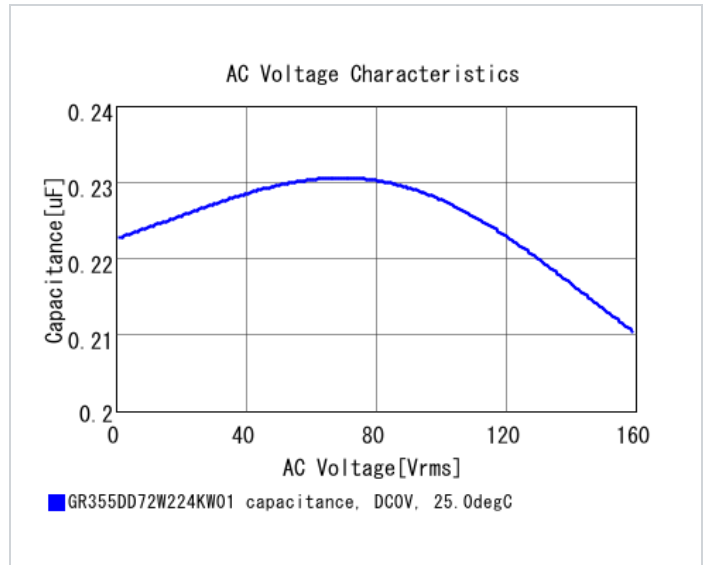
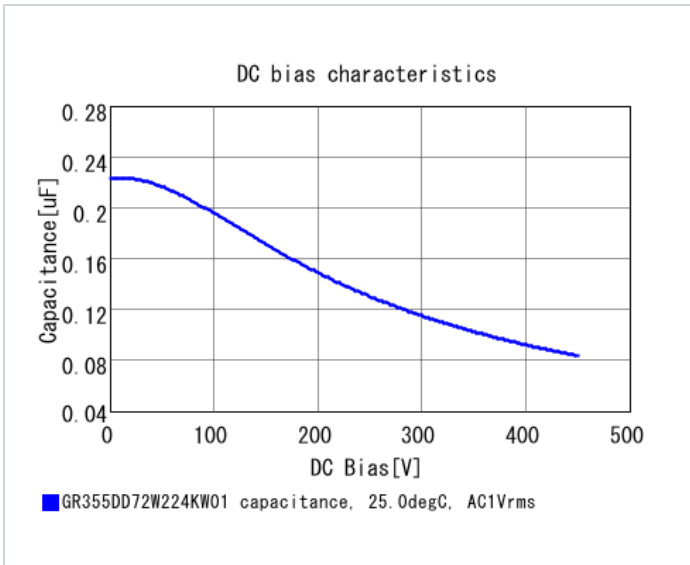
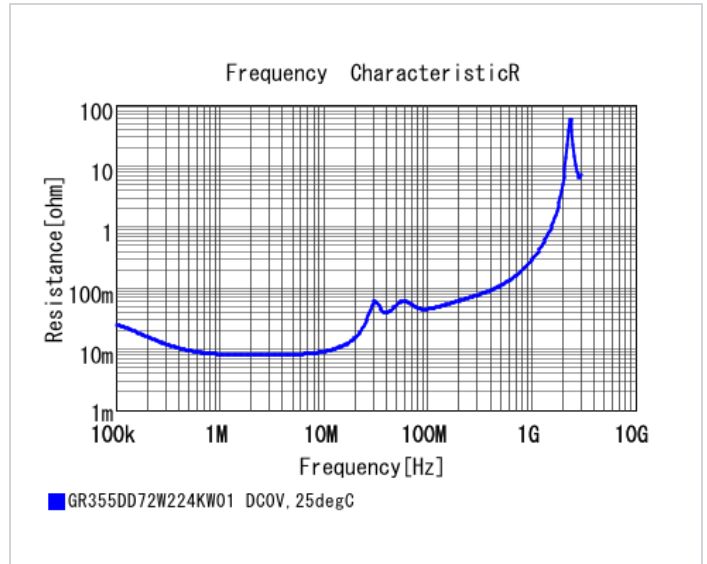
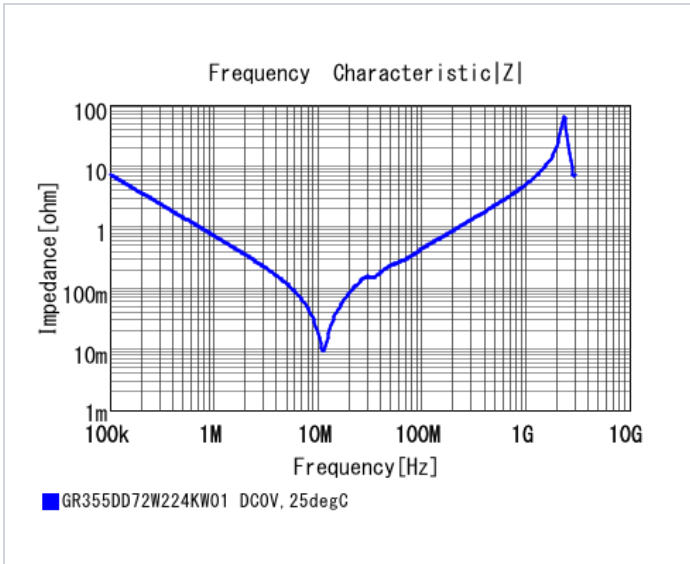

⚠ Attention

- 1.This datasheet is downloaded from the website of Murata Manufacturing Co., Ltd. Therefore, it's specifications are subject to change or our products in it may be discontinued without advance notice. Please check with our sales representatives or product engineers before ordering.
- 2.This datasheet has only typical specifications because there is no space for detailed specifications. Therefore, please review our product specifications or consult the approval sheet for product specifications before ordering.