



# SPECIFICATIONS



**CUSTOMER :** \_\_\_\_\_

**MODEL NO. :** **GFE128064O-GPAE-03**

**VERSION :** **B**

**DATE :** **2022.12.01**

**CERTIFICATION :** **ROHS**

Customer Sign	Approved By	Prepared By	Prepared By
			

晶發科技股份有限公司  
GI FAR TECHNOLOGY CO.,LTD.

新北市樹林區東豐街 81 號

No. 81, Dongfeng St, Shulin District, 238034, New Taipei City, Taiwan, R.O.C.

TEL: +886-2-8684-1188 FAX: +886-2-8684-8532





## CONTENTS

1. Scope	-----	4
2. Product Specifications	-----	4
2.1 General	-----	4
2.2 Mechanical Characteristics	-----	4
2.3 Absolute Maximum Ratings	-----	5
2.4 Electrical Characteristics	-----	5
2.5 Optical Characteristics Absolute maximum ratings	-----	5
2.6 Optical Characteristics	-----	6
2.7 LED Back-light Characteristics	-----	7
3. Reliability	-----	8
4. Operating Instructions	-----	9
4.1 Input signal Function	-----	9
4.2 Voltage Generator Circuit	-----	10
4.3 Timing Diagram	-----	11
4.4 Display Command	-----	13
5. Notes	-----	14
6. Operation Precautions	-----	14
7. LCM Dimensions	-----	15
8. Package information	-----	16
Appendix : Inspection Standard		



## 1. SCOPE

This specification covers the engineering requirements for the GFE128064O-GPAE-03 liquid crystal module.

## 2. PRODUCT SPECIFICATIONS

### 2.1 General

- 128 × 64 dot matrix LCD
- STN(GRAY), Positive mode LCD panel
- Transflective , Wide temperature type
- 6 o'clock
- Multiplexing driving : 1/64duty, 1/9bias
- Controller IC : RW1065
- Backlight: Yellow Green

### 2.2 Mechanical Characteristics

Item	Value	Unit
Number of dots	128X 64	Dot
Dot size	0.30 X 0.27	mm
Dot pitch	0.33 X 0.30	mm
Module dimension	78.00(W) X 37.00 (H) X 7.7MAX(T)	mm
Viewing Area	51.60 (W)X 21.80(H)	mm
Active Area	42.21 (W) X 19.17 (H)	mm
Remark	With zif connector CST 0.1uF/16V -> 1uF/16V	



## 2.3 Absolute Maximum Ratings (Without LED back-light)

Characteristic	Symbol	Unit	Value
Operating Voltage (logic)	V <sub>DD</sub>	V	-0.3 to +5.0
Input Voltage	V <sub>IN</sub>	V	-0.3 to V <sub>DD</sub> +0.3

Note 1: Referenced to V<sub>SS</sub>=0V

## 2.4 Electrical Characteristics (Without LED back-light)

Item	Symbol	Condition	Rating			Unit	Applicable Pin	
			Min.	Typ.	Max.			
Operating Voltage	V <sub>DD</sub>	-	2.7	3.0	3.3	V	V <sub>DD</sub> *1	
Step up output voltage	V <sub>out</sub>	(Relative to V <sub>DD</sub> )	0	-	17	V	V <sub>out</sub>	
Voltage follower circuit operating Voltage	V <sub>O</sub>	(Relative to V <sub>DD</sub> )	0	-	15	V	V <sub>O</sub>	
V <sub>O</sub> accuracy	V <sub>O</sub>	-	0	-	15	%	V <sub>O</sub>	
High-level Input Voltage Low-level Input Voltage	V <sub>IHC</sub> V <sub>ILC</sub>	-	0.7 V <sub>DD</sub> V <sub>SS</sub>	-	V <sub>DD</sub> 0.9	V	*2	
High-level Output Voltage Low-level Output Voltage	V <sub>OHC</sub> V <sub>OLC</sub>	I <sub>OH</sub> = -0.5 mA I <sub>OL</sub> = 0.5 mA	0.8V <sub>DD</sub> V <sub>SS</sub>	-	V <sub>DD</sub> 0.2 V <sub>DD</sub>	V	*3	
Input leakage current	I <sub>LI</sub>	V <sub>IN</sub> = V <sub>DD</sub> or V <sub>SS</sub>	-1	-	2	uA	*4	
Output leakage current	I <sub>LO</sub>	-	-1	-	1	uA	*5	
Liquid Crystal Driver ON Resistance	R <sub>ON</sub>	T <sub>a</sub> = 25°C (Relative To V <sub>DD</sub> ) V <sub>O</sub> = 15 V	-	1.6	2.0	KΩ	SEGN COMn *6	
Oscillator Frequency	Internal Oscillator	f <sub>OSC</sub>	T <sub>a</sub> = 25°C 1/32Duty	2.286	2.54	2.794	kHz	CL
	External Input RECOMMAND	f <sub>CL</sub>		2.286	2.54	2.794		
Oscillator Frequency	Internal Oscillator	f <sub>OSC</sub>	T <sub>a</sub> = 25°C 1/64Duty	4.5	5	5.5	kHz	CL
	External Input RECOMMAND	f <sub>CL</sub>		4.5	5	5.5		

\*Dynamic Consumption Current, During Display, with the Internal Power Supply OFF Current consumed by total ICs when an external power supply is used.

## 2.5 Optical Characteristics Absolute maximum ratings

Item	Symbol	Rating	Unit
Operating temperature range	Top	-20~70	°C
Storage temperature range	Tst	-30~80	°C



## 2.6. Optical Characteristics

1/64 duty, 1/9 bias,  $V_{op}=10V$ ,  $T_a=25^\circ C$

Item	Symbol	Conditions	Min.	Typ.	Max	Reference
Driving voltage	$V_{op}$		9.7	10	10.3	
Viewing angle	$\theta_1$ 、 $\theta_2$	$C \geq 2.0, \phi = 0^\circ C$	$30^\circ$	-		Notes 1 & 2
Contrast	C	$\theta = 5^\circ, \phi = 0^\circ$	2.0	-	-	Note 3
Response time(rise)	$t_{on}$	$\theta = 5^\circ, \phi = 0^\circ$	-	250	300ms	Note 4
Response time(fall)	$t_{off}$	$\theta = 5^\circ, \phi = 0^\circ$	-	250	350ms	Note 4

Note 1: Definition of angles  $\theta$  and  $\phi$

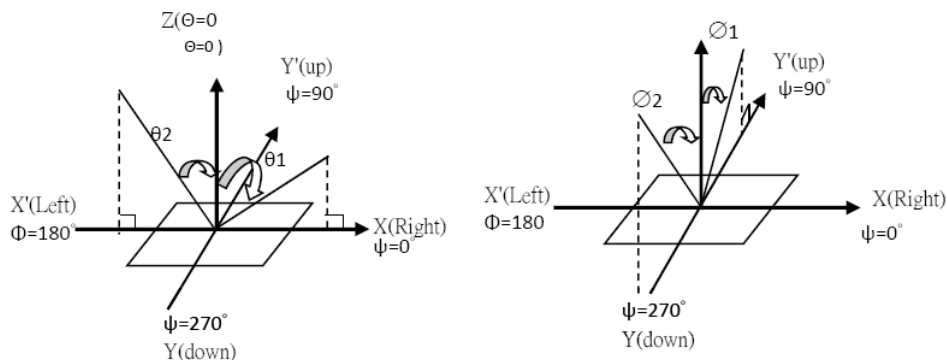

Note 2: Definition of viewing angles  $\theta_1$  and  $\theta_2$

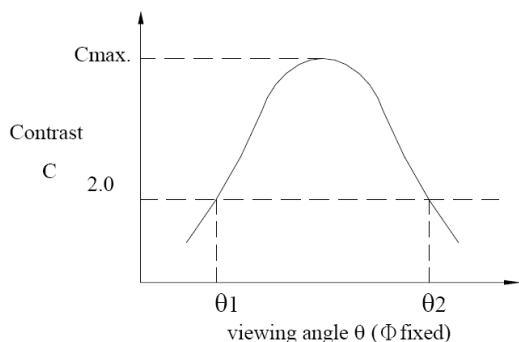

Note : Optimum viewing angle with the naked eye and viewing angle  $\theta$  at  $C_{max}$ . Above are not always the same

Note 3: Definition of contrast C

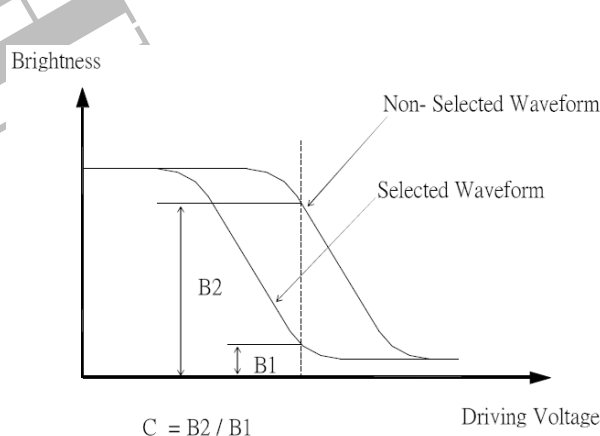

Note 4: Definition of response time

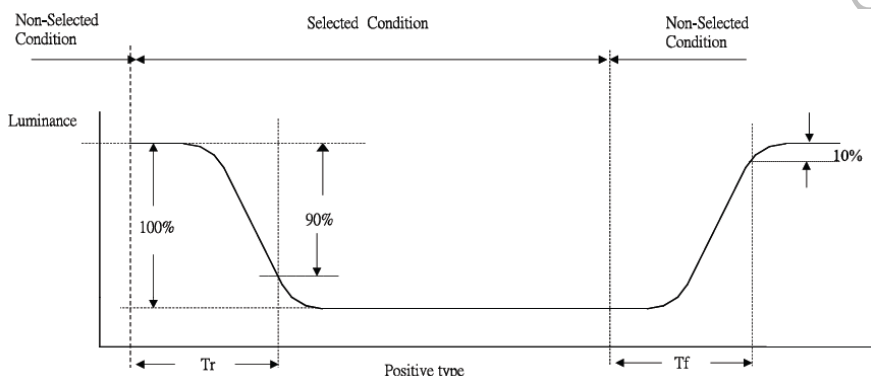



## 2.7 LED Back-light Characteristics

### 2.7.1 Electrical / optical specifications

Ta = 25°C

Item	Symbol	Condition	Min.	Typ.	Max.	Unit
Forward voltage	V <sub>f</sub>	I <sub>f</sub> =30mA, Yellow Green	3.7	4.0	4.3	V
*Luminous Intensity	I <sub>v</sub>	I <sub>f</sub> =30mA, Yellow Green	55	70	--	cd/m <sup>2</sup>
Peak Emission Wavelength	λ <sub>P</sub>	I <sub>f</sub> =30mA, Yellow Green	568	--	575	nm
Uniformity	Avg	I <sub>f</sub> =30mA, Yellow Green	70	--	--	%
Reverse Current	I <sub>R</sub>	V <sub>R</sub> =5V, Yellow Green	--	10	--	uA

Note: \* Measured at the bare LED back-light unit with LCD.

### 2.7.2 LED Maximum Operating Range

Item	Symbol	WHITE	Unit
Power Dissipation	P <sub>AD</sub>	180	mW
Forward Current	I <sub>F</sub>	45	mA
Reverse Voltage	V <sub>R</sub>	5	V



### 3. RELIABILITY

NO.	ITEM	CONDITION		STANDARD	NOTE
1	High Temp. Storage	80°C	120 hrs	Appearance Without defect	
2	Low Temp. Storage	-30°C	120 hrs	Appearance Without defect	
3	High Temp. & High Humi. Storage	40°C 90% RH	120 hrs	Appearance Without defect	
4	High Temp. Operating Display	70°C	120 hrs	Appearance Without defect	
5	Low Temp. Operating Display	-20°C	120 hrs	Appearance Without defect	
6	Thermal Shock	-20°C, 30min. → 70°C, 30min. ↑ (1cycle)		Appearance Without defect	10 cycles

\*\* Dissipation current, contrast and display functions

\*\* Polarizing filter deterioration, other appearance defects

\*\* The function test shall be conducted after 4hours storage at the normal temperature and humidity after remove from the test chamber.





## 4. OPERATING INSTRUCTIONS

### 4.1 Input signal Function

NO.	Symbol	Function
1	Vdd	Connected to the +5V 0r +3V dc power. Common to the Vcc MPU power pin.
2	VSS	0V dc pin connected to the system ground.
3	RS	Usually connected to the low-order bit of the MPU address bus and used to identify the data or a command. RS=0: D0 to D7 are display control data. RS=1: D0 to D7 are display data.
4	CS	Input. When CS = 0 the chip select become active
5	E	For 68-series MPU : Input. Active high. Used as an enable clock input of the 68-series MPU.
6	R/W	For 68-series MPU : Input. Used as an input pin of read control signals (if R/W is high) or write control signals signals (if low).
7~14	DB0-DB7	The 8-bit bidirectional data buses to be connected to the 8- or 16- bit standard MCU Data busses.
15	B/L-	Backlight power input pin (-)
16	B/L+	Backlight power input pin (+)
17	KPA1	Connector to S1 & S2 Tact switch
18	KPA2	Connector to S2 & S3 Tact switch
19	KPA3	Connector to S3 & S4 Tact switch
20	KPA4	Connector to S1 & S4 Tact switch
21	RESET	Input low active. System reset.
22	NC	NC
23	NC	NC
24	NC	NC



4.2 Circuit Block Diagram

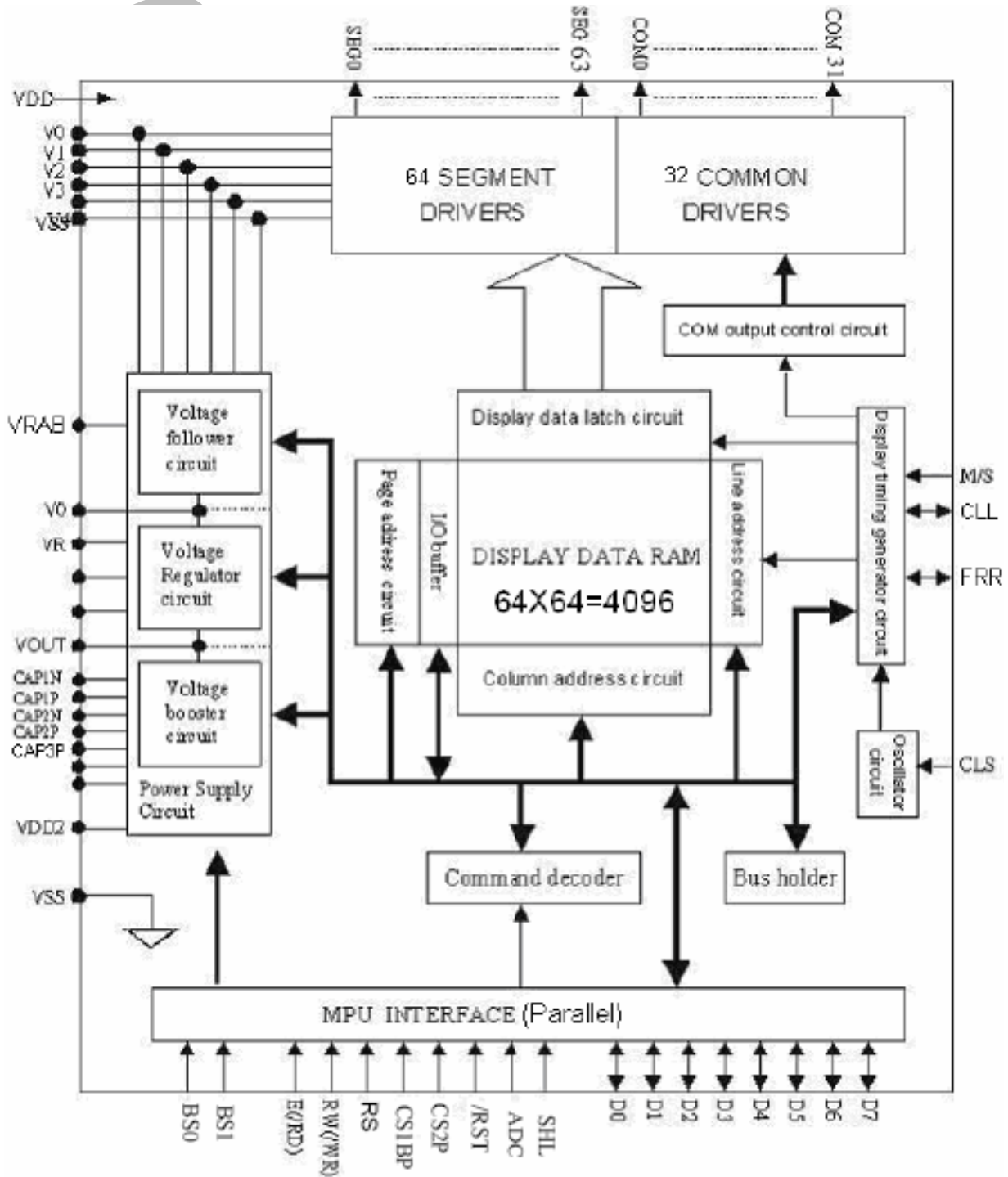



### 4.3 Timing Diagram

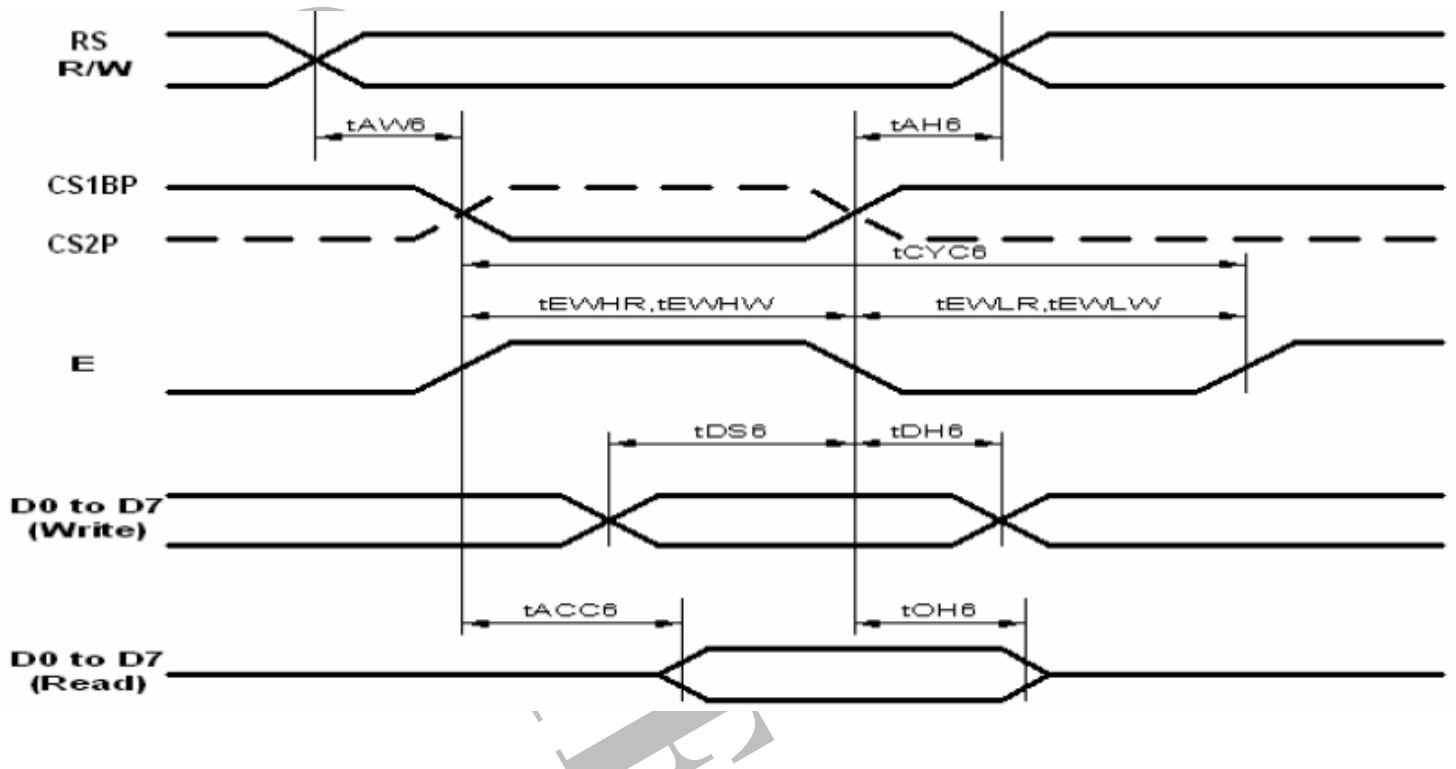

(Ta=-40 to 85 °C)

Item	Signal	Symbol	Condition	VDD=2.7 to 4.5V Rating		VDD=4.5 to 5.5V Rating		Units
				Min.	Max.	Min.	Max.	
Address hold time	RS	t <sub>AH6</sub>	—	0	—	0	—	ns
Address setup time	RS	t <sub>AW6</sub>		0	—	0	—	
System cycle time	RS	t <sub>CYC6</sub>	—	900	—	800	—	ns
Data setup time	D0 to D7	t <sub>DS6</sub>	—	100	—	100	—	ns
Data hold time	D0 to D7	t <sub>DH6</sub>		0	—	0	—	
Access time	D0 to D7	t <sub>ACC6</sub>	C <sub>L</sub> = 100 pF	—	350	—	250	ns
Output disable time	D0 to D7	t <sub>OH6</sub>		—	300	—	200	
Enable H pulse time	Read	E	—	360	—	300	—	ns
	Write	E		t <sub>EWHR</sub>	360	—	300	
Enable L pulse time	Read	E	—	450	—	400	—	ns
	Write	E		t <sub>EWLW</sub>	450	—	400	

\*1 All timing is specified using 20% and 80% of V<sub>DD</sub> as the reference.

\*2 t<sub>EVLW</sub> and t<sub>EWLR</sub> are specified as the overlap between CS1BP being "L" (CS2P = "H") and E.



➤ Reset Timing

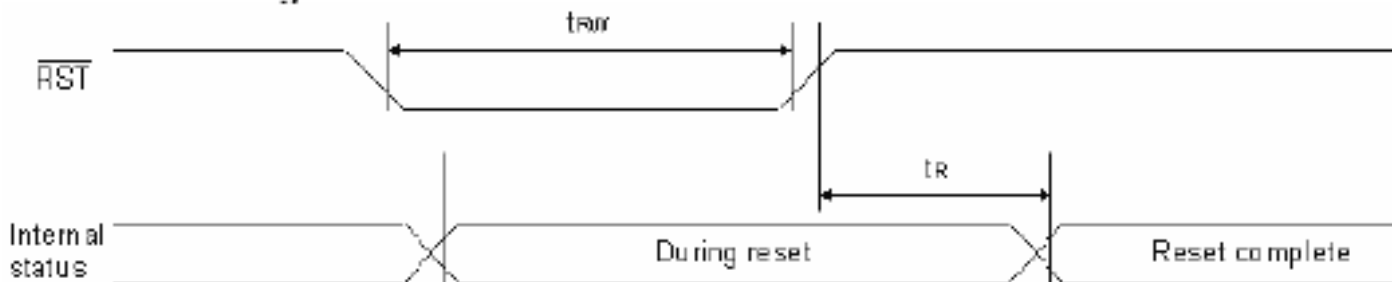

Item	Signal	Symbol	Condition	Rating			Units
				Min.	Typ.	Max.	
Reset time	—	$t_r$	—	—	-	2	$\mu s$
Reset "L" pulse width	RST	$t_{rw}$	—	2	-	—	$\mu s$

\*1 When double chip was be used, then the duty set command must be set between the  $t_r$

SAMPLE ONLY



#### 4.4.Display Command

Instruction	Instruction code										Description
	RS	RW	DB7	DB6	DB5	DB4	DB3	DB2	DB1	DB0	
<b>EXT=0 or 1</b>											
MODE SET	0	0	0	0	0	0	1	1	0	EXT	Set EXT mode

Instruction	Instruction code										Description
	RS	RW	DB7	DB6	DB5	DB4	DB3	DB2	DB1	DB0	
<b>EXT=0</b>											
Display ON/OFF	0	0	0	0	1	1	1	1	1	D	D=0:Display OFF D=1:Display ON
Set page address	0	0	1	0	1	1	1	P2	P1	P0	Set page address
Set column address	0	0	0	1	Y5	Y4	Y3	Y2	Y1	Y0	Set column address MSB
Read Status	0	1	BUSY	0	ON /OFF	RESET	0	0	0	0	Read register status
Write display data	1	0	Write data								Write data into DDRAM
Read display data	1	1	Read data								Read data from DDRAM
Set initial display line register	0	0	1	1	S5	S4	S3	S2	S1	S0	Specify the initial display line to realize vertical scrolling

Instruction	Instruction code										Description
	RS	RW	DB7	DB6	DB5	DB4	DB3	DB2	DB1	DB0	
<b>EXT=1</b>											
NOP	0	0	0	0	0	0	0	0	0	0	no operation
Set modiy-read	0	0	0	0	0	0	1	0	0	0	Set modiy-read mode
END	0	0	0	0	0	0	1	1	1	0	release modiy-read mode
Set power save mode	0	0	0	0	0	0	0	0	1	PSAVE	P=0: normal mode P=1: sleep mode
Display COMMAND (double command)	0	0	0	0	0	0	0	1	0	1	DUTY=1: 64 duty DUTY=0: 32 duty ALLON=1:display all on ALLON=0:display normal REV=1:display reverse REV=0:display normal FRSEL=1:FR frequency double default FRSEL=0:FR frequency default
			FRSEL	0	0	0	0	REV	ALL ON	DUTY	



## 5. NOTES

### ▪ Safety

- If the LCD panel breaks, be careful not to get the liquid crystal in your mouth. If the liquid crystal touches your skin or clothes, wash it off immediately using soap and plenty of water.

### Handling

- Avoid static electricity as this can damage the CMOS LSI.
- The LCD panel is plate glass; do not hit or crush it.
- Do not remove the panel or frame from the module.
- The polarizing plate of the display is very fragile; handle it very carefully

### Mounting and Design

- Mount the module by using the specified mounting part and holes.
- To protect the module from external pressure, leave a small gap by placing transparent plates (e.g. acrylic or glass ) on the display surface, frame, and polarizing plate
- Design the system so that no input signal is given unless the power-supply voltage is applied.
- Keep the module dry. Avoid condensation, otherwise the transparent electrodes may break.

### Storage

- Store the module in a dark place where the temperature is  $25\text{ }^{\circ}\text{C}\pm 10\text{ }^{\circ}\text{C}$  and the humidity below 65% RH.
- Do not store the module near organic solvents or corrosive gases.
- Do not crush, shake, or jolt the module (including accessories).

### Cleaning

- Do not wipe the polarizing plate with a dry cloth, as it may scratch the surface.
- Wipe the module gently with soft cloth soaked with a petroleum benzine.
- Do not use ketonic solvents (ketone and acetone) or aromatic solvents (toluene and xylene), as they may damage the polarizing plate.

## 6. OPERATION PRECAUTIONS

Any changes that need to be made in this specification or any problems arising from it will be dealt with quickly by discussion between both companies.

Quality warranty period: Within one year after shipment date (excluding abnormal usage way and abnormal environments.)



## 7. LCM Dimension

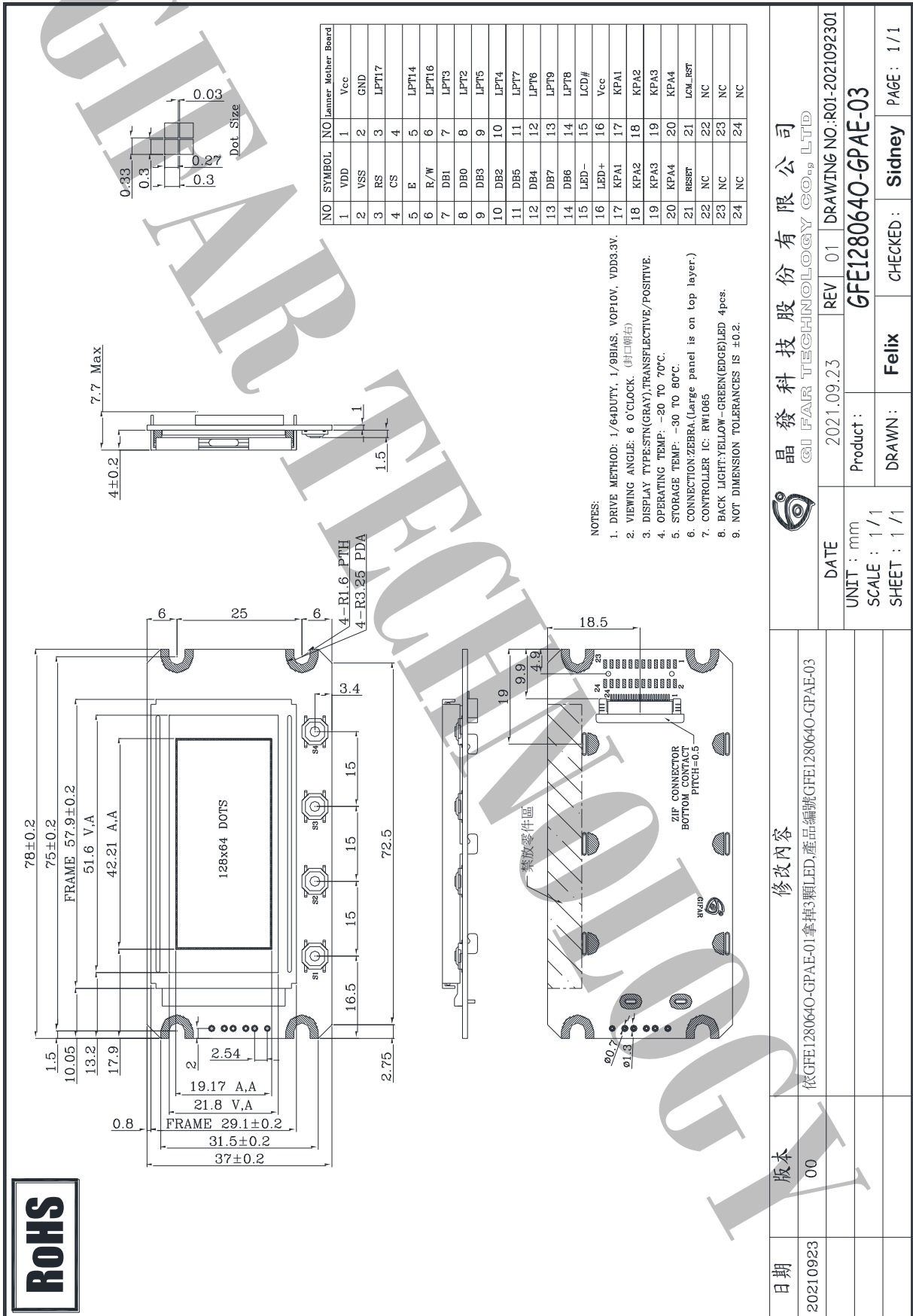



## 8. PACKAGE INFORMATION

1	1 Tray	:	24 pcs (modules)
2	1 stack	:	6 tray +1 Cover tray
3	1 Carton	:	(1 Cover tray + 6 tray )x 3 stack
4	Total pcs	:	1 Carton (24pcs*6tray * 3 stack) = 432 pcs
5	Carton size = NO. 17	:	495*315*435mm
7	Net weight	:	7.6 KG
8	Gross weight	:	11.5 KG

\*\* 示意圖片

- 一個 tray 盤 可放 24PCS 模組



- 6 盤+1 空盤=1 疊
- 一箱可放入 3 疊 ( 18 盤+3 空盤)
- 紙箱尺寸: 495\*315\*435mm
- 滿箱:432 PCS 淨重:7.6 KG 毛重:11.5 KG





出貨檢驗標準書  
Shipping inspection standard

核准 Approved by	審核 Checked by	作成 Made by
ANDY	JACKY	RUBY

**1.目的 Purpose :**

規範出貨產品之檢驗項目及判斷標準，確保產品出貨能滿足客戶要求。

Standardize the inspection items and judgment standards to ensure the products that shipped out can meet customer's requirements.

**2.範圍 Area :**

適用於出廠之所有產品。

Applicable to all products shipped from the factory.

**3.名詞解釋 Explanation of terms :**

3-1 主要缺陷：亦會造成功能缺失或嚴重外觀缺陷。

Major Defects: It also causes loss of function or serious appearance defects.

3-2 次要缺陷：稍有缺陷但不影響客戶使用。

Minor defect: Slightly defective but does not affect customer use.

**4.檢驗體制 Inspection system :**

4-1 抽樣計劃：依 ANSI/ASQ Z1.4 一般檢驗水準 II 之 正常檢驗一次抽驗方案。

Sampling plan: According to ANSI/ASQ Z1.4 general inspection level II the normal inspection one-time sampling plan.

4-2 允收水準 Acceptable Level : (AQL)

主要缺陷 Major defect : 0.4 %

次要缺陷 Minor defect : 0.65 %

**5.檢驗條件 Inspection conditions :**

5-1 使用相關之檢測儀器及測試、量測工具。

Use relevant testing instrument, testing and measuring tools .

5-2 環境要求：其條件需控制在常溫下  $23^{\circ}\text{C}\pm 3^{\circ}\text{C}$  及溼度 70%RH 以下。

Environmental requirements: The conditions should be controlled at room temperature  $23^{\circ}\text{C}\pm 3^{\circ}\text{C}$  and humidity below 70%RH.

5-3 外觀檢驗：須在  $380\pm 20\%$  LUX 的白色日光燈下，其目視距離需於產品離  $30\pm 5$  cm 檢驗。

Appearance inspection: Under the white fluorescent lamp of  $380\pm 20\%$  LUX , the visual distance shall be checked above the product  $30 \pm 5$  cm.

5-4 電性測試 Electrical Testing :

5-4-1 有背光之產品需關燈並在  $5\sim 300\text{Lux}\pm 3\%$  下檢驗。

The products with backlight should be tested at  $5\sim 300\pm 3\%$  Lux.

5-4-2 無背光之產品需開燈並在  $60\sim 300\text{Lux}\pm 3\%$  白色日光燈下檢驗。

Products without backlight need to be turned on and tested under  $60\sim 300 \pm 3\%$  LUX white fluorescent lamps .

5-5 檢查視角依產品視角方向。

Check the viewing angle according to the product viewing angle.

5-6 其不良現象檢視區域 Bad phenomenon View area

5-6-1 適用種類 Applicable category : COB、TFT

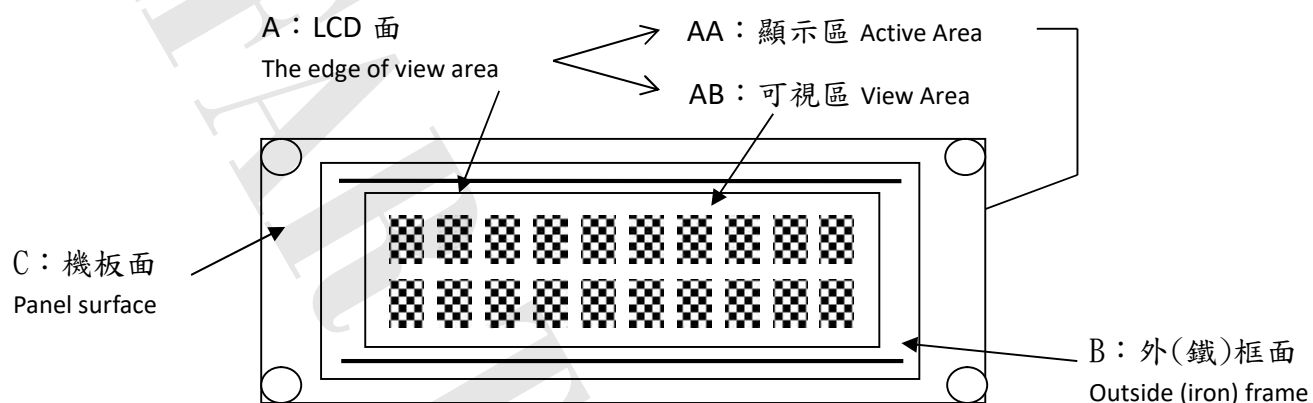

5-6-2 適用種類 Applicable category : COG、TAB、TN

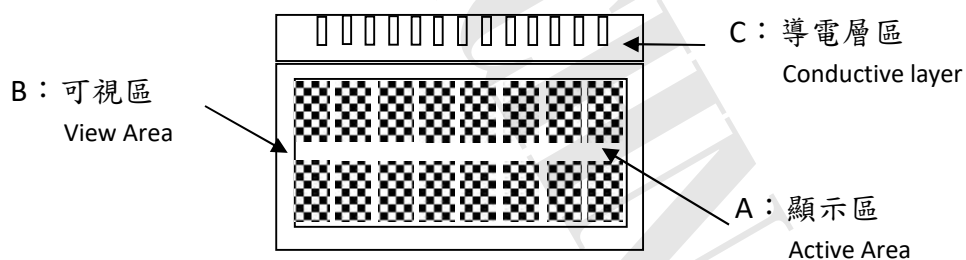

6. 檢驗標準 Inspection standards

COB

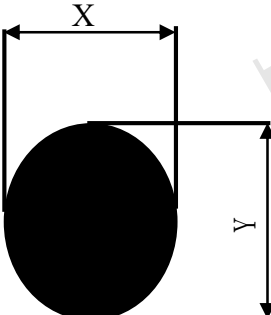
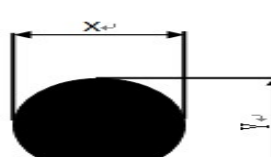
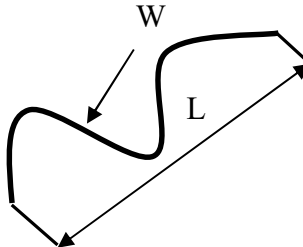
種類 Category		COB																			
編號 No.	檢驗項目 Item	檢驗內容及判定標準 Inspection Content & Standard	區域 Zone	類別 Category	缺陷等級 Level																
1	點類(一) Dot (1)	黑點、刺傷...等圓狀 Black dot、Stab...and other round shape  $\varphi = \frac{(X + Y)}{2}$ 	兩點距離須超過 5 mm Two points have to be $\geq 5$ mm  <table border="1"> <thead> <tr> <th><math>\varphi</math> (mm)</th> <th>允收數 Acceptance Qty</th> </tr> </thead> <tbody> <tr> <td><math>\phi \leq 0.1</math></td> <td>無視 Ignore</td> </tr> <tr> <td><math>0.1 &lt; \phi \leq 0.25</math></td> <td>3</td> </tr> <tr> <td><math>0.25 &lt; \phi \leq 0.3</math></td> <td>1</td> </tr> <tr> <td><math>\phi &gt; 0.3</math></td> <td>0</td> </tr> </tbody> </table>	$\varphi$ (mm)	允收數 Acceptance Qty	$\phi \leq 0.1$	無視 Ignore	$0.1 < \phi \leq 0.25$	3	$0.25 < \phi \leq 0.3$	1	$\phi > 0.3$	0	A	外觀 Appearance	次要 Minor AQL0.65%					
		$\varphi$ (mm)	允收數 Acceptance Qty																		
$\phi \leq 0.1$	無視 Ignore																				
$0.1 < \phi \leq 0.25$	3																				
$0.25 < \phi \leq 0.3$	1																				
$\phi > 0.3$	0																				
其點位於側邊 無視 The dot is located on the side(B area)-OK  <table border="1"> <thead> <tr> <th><math>\varphi</math> (mm)</th> <th>允收數 Acceptance Qty</th> </tr> </thead> <tbody> <tr> <td><math>\phi \leq 0.3</math></td> <td>無視 Ignore</td> </tr> <tr> <td><math>0.3 &lt; \phi \leq 0.5</math></td> <td>3</td> </tr> <tr> <td><math>0.5 &lt; \phi \leq 1</math></td> <td>1</td> </tr> <tr> <td><math>\phi &gt; 1</math></td> <td>0</td> </tr> </tbody> </table>	$\varphi$ (mm)	允收數 Acceptance Qty	$\phi \leq 0.3$	無視 Ignore	$0.3 < \phi \leq 0.5$	3	$0.5 < \phi \leq 1$	1	$\phi > 1$	0	B	外觀 Appearance	次要 Minor AQL0.65%								
$\varphi$ (mm)	允收數 Acceptance Qty																				
$\phi \leq 0.3$	無視 Ignore																				
$0.3 < \phi \leq 0.5$	3																				
$0.5 < \phi \leq 1$	1																				
$\phi > 1$	0																				
2	點類(二) Dot (2)	氣泡、凹凸點 Bubble、Uneven dots  $\varphi = \frac{(X + Y)}{2}$ 	兩點距離須超過 5 mm Two points to be $\geq 5$ mm  <table border="1"> <thead> <tr> <th><math>\varphi</math> (mm)</th> <th>允收數 Acceptance Qty</th> </tr> </thead> <tbody> <tr> <td><math>\phi \leq 0.2</math></td> <td>無視 Ignore</td> </tr> <tr> <td><math>0.2 &lt; \phi \leq 0.5</math></td> <td>2</td> </tr> <tr> <td><math>\phi &gt; 0.5</math></td> <td>0</td> </tr> </tbody> </table>	$\varphi$ (mm)	允收數 Acceptance Qty	$\phi \leq 0.2$	無視 Ignore	$0.2 < \phi \leq 0.5$	2	$\phi > 0.5$	0	A	外觀 Appearance	次要 Minor AQL0.65%							
$\varphi$ (mm)	允收數 Acceptance Qty																				
$\phi \leq 0.2$	無視 Ignore																				
$0.2 < \phi \leq 0.5$	2																				
$\phi > 0.5$	0																				
3	線類 Line	刮傷、毛屑...等線狀 Scratch、Fiber.. and other linear shape.  	<table border="1"> <thead> <tr> <th>L (mm)</th> <th>W (mm)</th> <th>允收數 Acceptance Qty</th> </tr> </thead> <tbody> <tr> <td>--</td> <td><math>W \leq 0.02</math></td> <td>無視 Ignore</td> </tr> <tr> <td><math>L \leq 5</math></td> <td><math>W \leq 0.03</math></td> <td>3</td> </tr> <tr> <td><math>L \leq 3</math></td> <td><math>W \leq 0.05</math></td> <td>2</td> </tr> <tr> <td><math>L &gt; 5</math></td> <td><math>W &gt; 0.05</math></td> <td>0</td> </tr> </tbody> </table>	L (mm)	W (mm)	允收數 Acceptance Qty	--	$W \leq 0.02$	無視 Ignore	$L \leq 5$	$W \leq 0.03$	3	$L \leq 3$	$W \leq 0.05$	2	$L > 5$	$W > 0.05$	0	A	外觀 Appearance	次要 Minor AQL0.65%
L (mm)	W (mm)	允收數 Acceptance Qty																			
--	$W \leq 0.02$	無視 Ignore																			
$L \leq 5$	$W \leq 0.03$	3																			
$L \leq 3$	$W \leq 0.05$	2																			
$L > 5$	$W > 0.05$	0																			
4	底色 Background color	同批供貨不能有明顯色差 No obvious color difference allowed in same shipment. (必要時與客端制定限度樣) (According to the gold samples if necessary)	A	外觀 Appearance	次要 Minor AQL0.65%																

5	零件位置 Parts position	與工程 BOM 上標示不符 拒收 Different with the BOM marked Reject	C	外觀 Appearance	主要 Major AQL 0.4%
6	板面潔淨 FPC/PCB's surface is clean	※ 焊接面上附著錫渣、珠 拒收 Solder side has tin slag, beads or particle Reject ※ 焊接面上附著於過多錫油 拒收 Solder side has too much tin oil Reject	C	外觀 Appearance	次要 Minor AQL0.65%
7	點、線類 (三) Dot、Line (3)	※ 於全黑、白畫面下看見之區塊狀或線狀不良 拒收 There is a block or linear in the view area under the screen is whole black or white. Reject ※ 但依 2% ND Filter 遮蓋無視 允收 But after inspecting by 2% ND Filter without seeing block or linear, it is confirmed Acceptance	AA	電訊 Electronics	次要 Minor AQL0.65%
8	點、線類 (四) Dot、Line (4)	畫面中顯示出現黑、白、亮、異色點或線狀 There is a black, white, bright or other dot or lines showing in the view area. ※ 依編號 1、3 之判定標準 According to the inspection standard: No. 1 and 3.	AA	電訊 Electronics	次要 Minor AQL0.65%
9	缺字 Lack of characters	顯示時畫面缺少部份字元 拒收 Lacking part of characters in the view area. Reject	AA	電訊 Electronics	主要 Major AQL 0.4%
10	無動作 No reaction	顯示畫面一直處於起始畫面而無法進行切換 拒收 The display (view area) always shows in the initial screen and can't be switched to others. Reject	AA	電訊 Electronics	主要 Major AQL 0.4%
11	無畫面 No display	通電後，完全無任何畫面顯示 拒收 After connecting to the power, there is no display. Reject	AA	電訊 Electronics	主要 Major AQL 0.4%
12	斷線 Broken line	顯示畫面中少直、橫線 拒收 There is a lack of vertical or horizontal lines in the view area. Reject	AA	電訊 Electronics	主要 Major AQL 0.4%
13	CROSS TALK	顯示畫面時有局部之條紋或拖影 There are some stripes or shadow/smear showing in the view area. 拒收或與客端簽訂限度樣 Reject or inspect according to the golden sample	AA	電訊 Electronics	次要 Minor AQL0.65%

14	I CON	顯示畫面缺少部份顯示圖案 拒收 Lack of partial ICON in the view area. Reject	AA	電訊 Electronics	主要 Major AQL 0.4%
15	深淺不一 Color difference	顯示畫面的對比，比其他顯示深或淺並依電氣規格(VOP) 值判定 The contrast of display is obviously lighter or darker than others and according to the VOP value in the electronics specification. 拒收或與客端簽訂限度樣 Reject or inspect according to the golden sample	AA	電訊 Electronics	次要 Minor AQL0.65%
16	畫面異常 Abnormal screen	通電後畫面出現未定義之電訊不良現象 拒收 After connecting to the power, there is an undefined electronics appearance showing in the view area. Reject	AA	電訊 Electronics	主要 Major AQL 0.4%
17	背光色不均 Uneven color of backlight	※ 點亮後 LED 有明暗不均現象依其均勻度判定 拒收 After lighting LEDs have brightness and darkness uneven the determined according to its uniformity. Reject ※ 點亮後 LED 色澤不一致 拒收 LED color is inconsistent after lighting Reject	A	電訊 Electronics	次要 Minor AQL0.65%
18	亮度不足 Lack of brightness	波長、色座標、輝度與圖面標示定義不符 拒收 Wave length, chromatic coordinates, brightness don't correspond to the definition of the drawing. Reject	A	電訊 Electronics	次要 Minor AQL0.65%
19	尺寸量測 Size Measurement	未依圖面上標示 拒收 No correspond to the indication on the drawing. Reject	ALL	外觀 Appearance	主要 Major AQL 0.4%
20	其他 Other	如發現有上述未定義之不良則與客端簽訂限度樣 If there is another undefined defective situation. It will be listed as others. The inspection standard is according to the golden sample.	ALL	電訊 Electronics 外觀 Appearance	次要 Minor AQL0.65%