

Field Stop Trench IGBT

650 V, 40 A

FGHL40T65MQD

Field stop 4th generation mid speed IGBT technology and full current rated copak Diode technology.

Features

- Maximum Junction Temperature: $T_J = 175^\circ\text{C}$
- Positive Temperature Co-efficient for Easy Parallel Operating
- High Current Capability
- Low Saturation Voltage: $V_{CE(sat)} = 1.45\text{ V (Typ.) @ } I_C = 40\text{ A}$
- 100% of the Parts are Tested for I_{LM} (Note 2)
- Smooth & Optimized Switching
- Tight Parameter Distribution
- RoHS Compliant

Typical Applications

- Solar Inverter
- UPS, ESS
- PFC, Converters

MAXIMUM RATINGS

Parameter	Symbol	Value	Unit	
Collector-to-Emitter Voltage	V_{CES}	650	V	
Gate-to-Emitter Voltage	V_{GES}	± 20	V	
Transient Gate-to-Emitter Voltage	V_{GES}	± 30	V	
Collector Current (Note 1)	I_C	$T_C = 25^\circ\text{C}$	80	A
		$T_C = 100^\circ\text{C}$	40	
Pulsed Collector Current (Note 2)	I_{LM}	160	A	
Pulsed Collector Current (Note 3)	I_{CM}	160	A	
Diode Forward Current (Note 1)	I_F	$T_C = 25^\circ\text{C}$	40	A
		$T_C = 65^\circ\text{C}$	25	
Pulsed Diode Maximum Forward Current	I_{FM}	160	A	
Non-Repetitive Forward Surge Current (Half-Sine Pulse, $t_p = 8.3\text{ ms}$, $T_C = 25^\circ\text{C}$) (Half-Sine Pulse, $t_p = 8.3\text{ ms}$, $T_C = 150^\circ\text{C}$)	$I_{F,SM}$		85	A
			80	
Maximum Power Dissipation	P_D	$T_C = 25^\circ\text{C}$	238	W
		$T_C = 100^\circ\text{C}$	119	
Operating Junction and Storage Temperature Range	T_J, T_{stg}	-55 to +175	$^\circ\text{C}$	
Maximum Lead Temperature for Soldering Purposes (1/8" from case for 5 s)	T_L	300	$^\circ\text{C}$	

Stresses exceeding those listed in the Maximum Ratings table may damage the device. If any of these limits are exceeded, device functionality should not be assumed, damage may occur and reliability may be affected.

1. Value limit by bond wire
2. $V_{CC} = 400\text{ V}$, $V_{GE} = 15\text{ V}$, $I_C = 160\text{ A}$, $R_G = 14\ \Omega$, Inductive Load, 100% Tested
3. Repetitive rating: Pulse width limited by max. junction temperature



ON Semiconductor®

www.onsemi.com

BV_{CES}	$V_{CE(sat)}$ TYP	I_C MAX
650 V	1.45 V	40 A

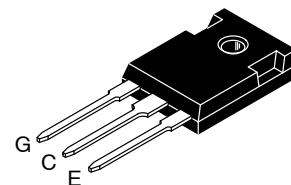
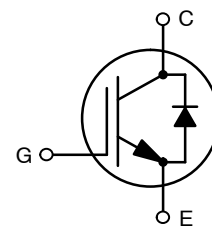

TO-247 LONG LEADS
CASE 340CX

MARKING DIAGRAM

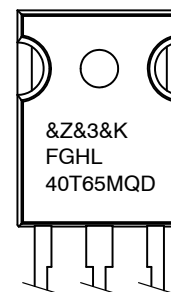

&Z = Assembly Plant Code
 &3 = 3-Digit Date Code
 &K = 2-Digit Lot Traceability Code
 FGHL40T65MQD = Specific Device Code

ORDERING INFORMATION

Device	Package	Shipping
FGHL40T65MQD	TO-247-3L	30 Units / Rail

FGHL40T65MQD

Table 1. THERMAL CHARACTERISTICS

Parameter	Symbol	Value	Unit
Thermal Resistance Junction-to-Case, for IGBT	$R_{\theta JC}$	0.63	°C/W
Thermal Resistance Junction-to-Case, for Diode	$R_{\theta JC}$	1.6	
Thermal Resistance Junction-to-Ambient	$R_{\theta JA}$	40	

Table 2. ELECTRICAL CHARACTERISTICS ($T_J = 25^\circ\text{C}$ unless otherwise specified)

Parameter	Test Conditions	Symbol	Min	Typ	Max	Unit
OFF CHARACTERISTIC						
Collector-emitter breakdown voltage, gate-emitter short-circuited	$V_{GE} = 0\text{ V}, I_C = 1\text{ mA}$	BV_{CES}	650	-	-	V
Temperature Coefficient of Breakdown Voltage	$V_{GE} = 0\text{ V}, I_C = 1\text{ mA}$	$\Delta BV_{CES} / \Delta T_J$	-	0.6	-	V/°C
Collector-emitter cut-off current, gate-emitter short-circuited	$V_{GE} = 0\text{ V}, V_{CE} = 650\text{ V}$	I_{CES}	-	-	250	μA
Gate leakage current, collector-emitter short-circuited	$V_{GE} = 20\text{ V}, V_{CE} = 0\text{ V}$	I_{GES}	-	-	±400	nA
ON CHARACTERISTIC						
Gate-emitter threshold voltage	$V_{GE} = V_{CE}, I_C = 40\text{ mA}$	$V_{GE(th)}$	3.0	4.5	6.0	V
Collector-emitter saturation voltage	$V_{GE} = 15\text{ V}, I_C = 40\text{ A}$ $V_{GE} = 15\text{ V}, I_C = 40\text{ A}, T_J = 175^\circ\text{C}$	$V_{CE(sat)}$	-	1.45 1.77	1.8 -	V
DYNAMIC CHARACTERISTIC						
Input capacitance	$V_{CE} = 30\text{ V}, V_{GE} = 0\text{ V}, f = 1\text{ MHz}$	C_{ies}	-	2756	-	pF
Output capacitance		C_{oes}	-	64	-	
Reverse transfer capacitance		C_{res}	-	9	-	
Gate charge total	$V_{CE} = 400\text{ V}, I_C = 40\text{ A}, V_{GE} = 15\text{ V}$	Q_g	-	86	-	nC
Gate-to-Emitter charge		Q_{ge}	-	16	-	
Gate-to-Collector charge		Q_{gc}	-	21	-	
SWITCHING CHARACTERISTIC, INDUCTIVE LOAD						
Turn-on delay time	$T_C = 25^\circ\text{C}$ $V_{CC} = 400\text{ V}, I_C = 20\text{ A}$ $R_G = 10\ \Omega$ $V_{GE} = 15\text{ V}$ Inductive Load	$t_{d(on)}$	-	20	-	ns
Rise time		t_r	-	13	-	
Turn-off delay time		$t_{d(off)}$	-	116	-	
Fall time		t_f	-	51	-	
Turn-on switching loss		E_{on}	-	0.33	-	mJ
Turn-off switching loss		E_{off}	-	0.26	-	
Total switching loss		E_{ts}	-	0.59	-	
Turn-on delay time	$T_C = 25^\circ\text{C}$ $V_{CC} = 400\text{ V}, I_C = 40\text{ A}$ $R_G = 10\ \Omega$ $V_{GE} = 15\text{ V}$ Inductive Load	$t_{d(on)}$	-	22	-	ns
Rise time		t_r	-	30	-	
Turn-off delay time		$t_{d(off)}$	-	109	-	
Fall time		t_f	-	46	-	
Turn-on switching loss		E_{on}	-	0.86	-	mJ
Turn-off switching loss		E_{off}	-	0.52	-	
Total switching loss		E_{ts}	-	1.38	-	

FGHL40T65MQD

Table 2. ELECTRICAL CHARACTERISTICS ($T_J = 25^\circ\text{C}$ unless otherwise specified) (continued)

Parameter	Test Conditions	Symbol	Min	Typ	Max	Unit
SWITCHING CHARACTERISTIC, INDUCTIVE LOAD						
Turn-on delay time	$T_C = 175^\circ\text{C}$ $V_{CC} = 400\text{ V}, I_C = 20\text{ A}$ $R_G = 10\ \Omega$ $V_{GE} = 15\text{ V}$ Inductive Load	$t_{d(on)}$	–	20	–	ns
Rise time		t_r	–	14	–	
Turn-off delay time		$t_{d(off)}$	–	127	–	
Fall time		t_f	–	76	–	
Turn-on switching loss		E_{on}	–	0.60	–	mJ
Turn-off switching loss		E_{off}	–	0.42	–	
Total switching loss		E_{ts}	–	1.02	–	
Turn-on delay time	$T_C = 175^\circ\text{C}$ $V_{CC} = 400\text{ V}, I_C = 40\text{ A}$ $R_G = 10\ \Omega$ $V_{GE} = 15\text{ V}$ Inductive Load	$t_{d(on)}$	–	20	–	ns
Rise time		t_r	–	32	–	
Turn-off delay time		$t_{d(off)}$	–	119	–	
Fall time		t_f	–	63	–	
Turn-on switching loss		E_{on}	–	1.28	–	mJ
Turn-off switching loss		E_{off}	–	0.77	–	
Total switching loss		E_{ts}	–	2.05	–	
DIODE CHARACTERISTIC2.5						
Diode Forward Voltage	$I_F = 40\text{ A}, T_C = 25^\circ\text{C}$ $I_F = 40\text{ A}, T_C = 175^\circ\text{C}$	V_{FM}	– –	2.55 2.3	2.85 –	V
Reverse Recovery Energy	$I_F = 40\text{ A}, di_F/dt = 200\text{ A}/\mu\text{s}, T_C = 175^\circ\text{C}$	E_{rec}	–	56	–	μJ
Diode Reverse Recovery Time	$I_F = 40\text{ A}, di_F/dt = 200\text{ A}/\mu\text{s}, T_C = 25^\circ\text{C}$ $I_F = 40\text{ A}, di_F/dt = 200\text{ A}/\mu\text{s}, T_C = 175^\circ\text{C}$	T_{rr}	–	33 222	–	ns
Diode Reverse Recovery Charge	$I_F = 40\text{ A}, di_F/dt = 200\text{ A}/\mu\text{s}, T_C = 25^\circ\text{C}$ $I_F = 40\text{ A}, di_F/dt = 200\text{ A}/\mu\text{s}, T_C = 175^\circ\text{C}$	Q_{rr}	–	47 759	–	nC

Product parametric performance is indicated in the Electrical Characteristics for the listed test conditions, unless otherwise noted. Product performance may not be indicated by the Electrical Characteristics if operated under different conditions.

FGHL40T65MQD

TYPICAL CHARACTERISTICS

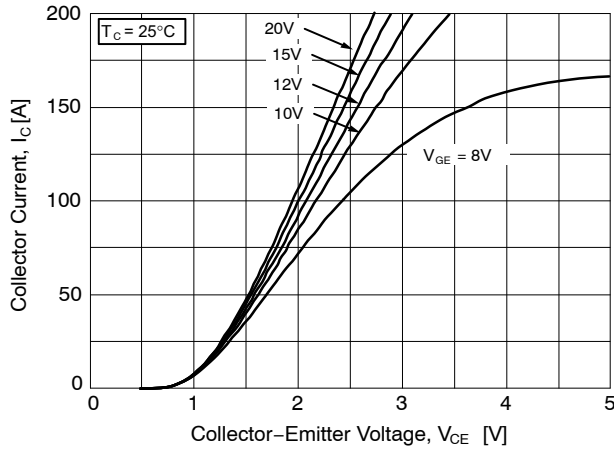

Figure 1. Typical Output Characteristics
($T_J = 25^\circ\text{C}$)

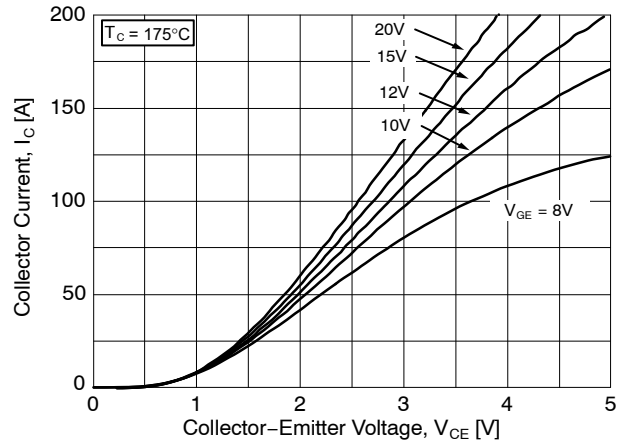

Figure 2. Typical Output Characteristics
($T_J = 175^\circ\text{C}$)

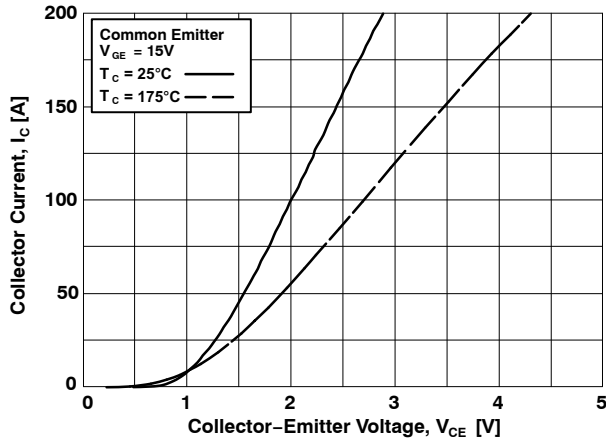

Figure 3. Typical Saturation Voltage Characteristics

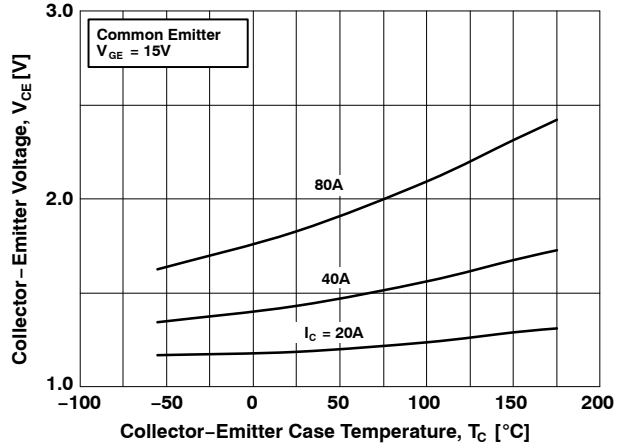

Figure 4. Saturation Voltage vs. Case Temperature at Variant Current Level

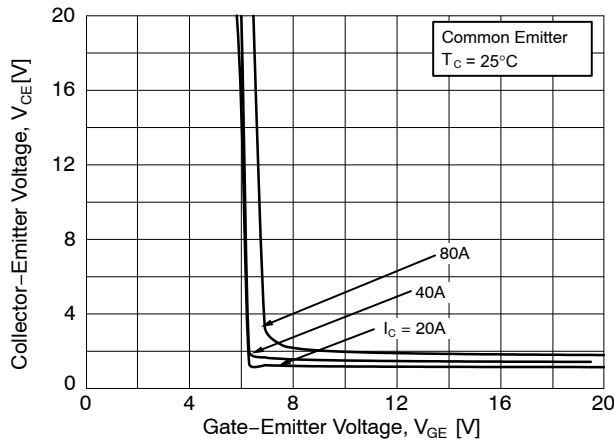

Figure 5. Saturation Voltage vs. V_{GE} ($T_J = 25^\circ\text{C}$)

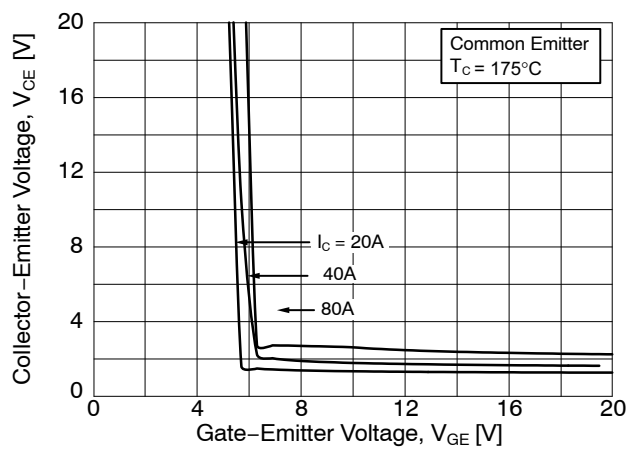

Figure 6. Saturation Voltage vs. V_{GE} ($T_J = 175^\circ\text{C}$)

FGHL40T65MQD

TYPICAL CHARACTERISTICS (continued)

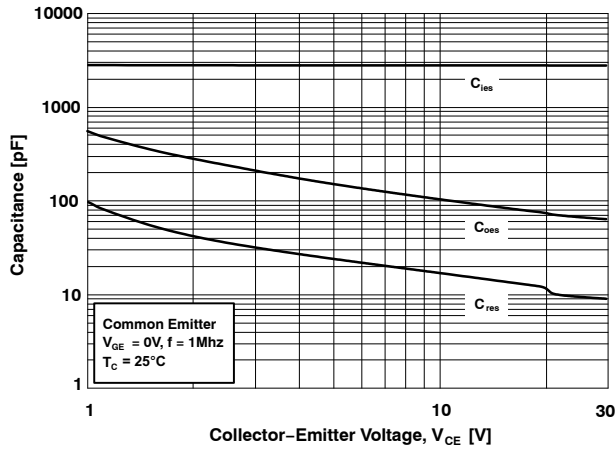

Figure 7. Capacitance Characteristics

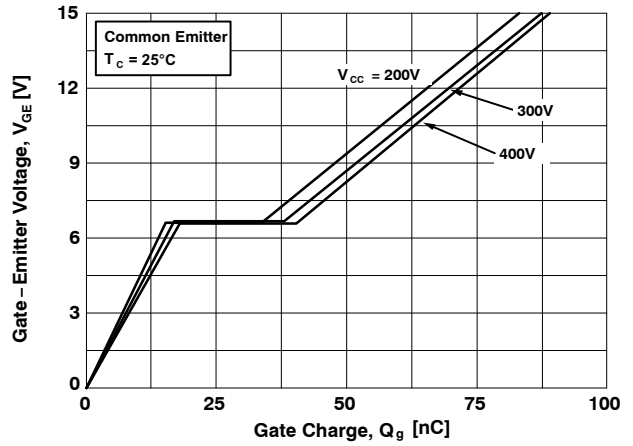

Figure 8. Gate Charge Characteristics

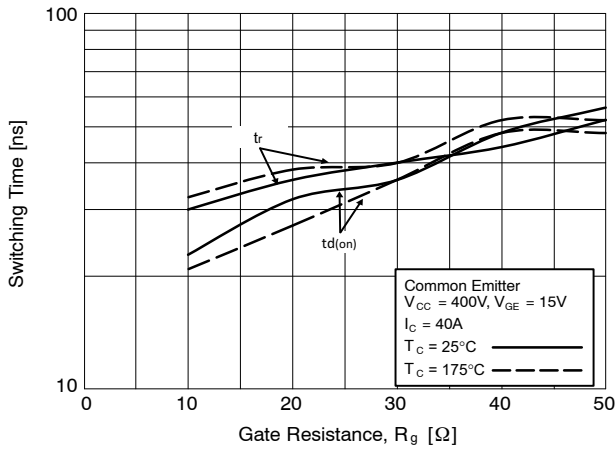

Figure 9. Turn-On Characteristics vs. Gate Resistance

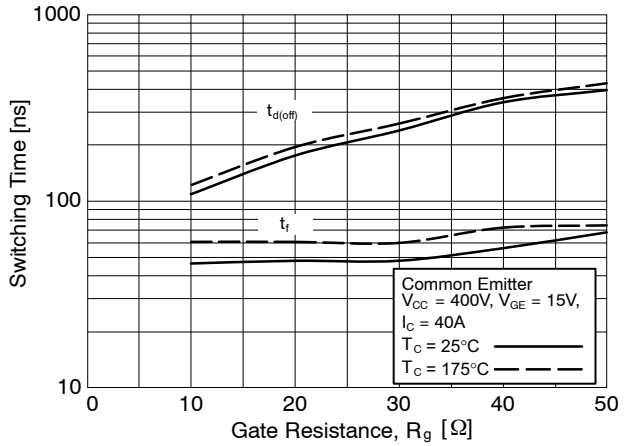

Figure 10. Turn-Off Characteristics vs. Gate Resistance

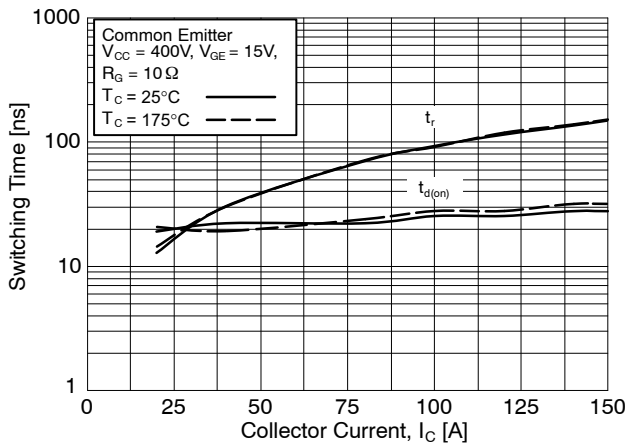

Figure 11. Turn-On Characteristics vs. Collector Current

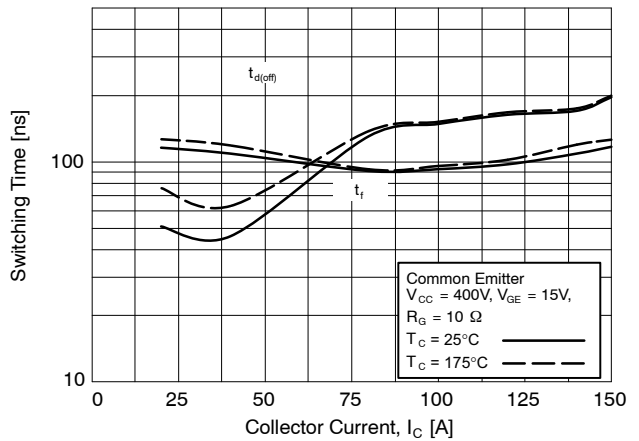

Figure 12. Turn-Off Characteristics vs. Collector Current

FGHL40T65MQD

TYPICAL CHARACTERISTICS (continued)

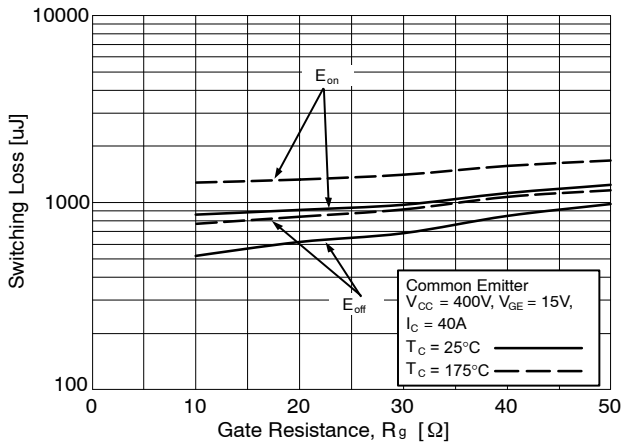

Figure 13. Switching Loss vs. Gate Resistance

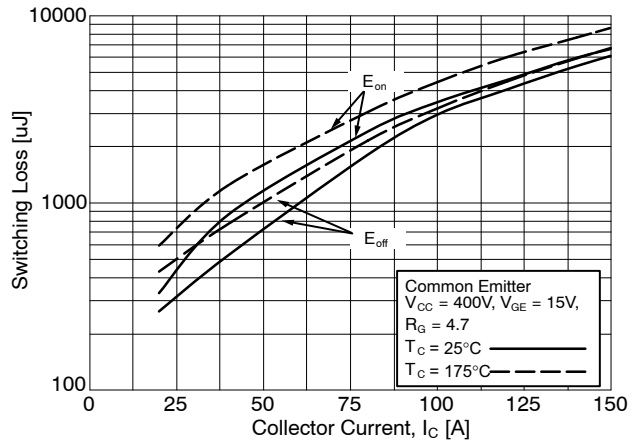

Figure 14. Switching Loss vs. Collector Current

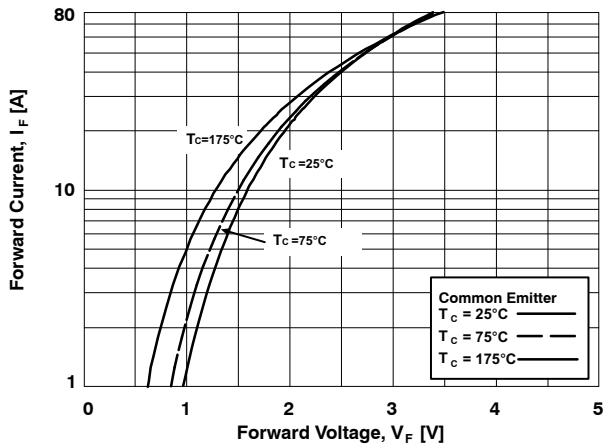

Figure 15. Forward Characteristics

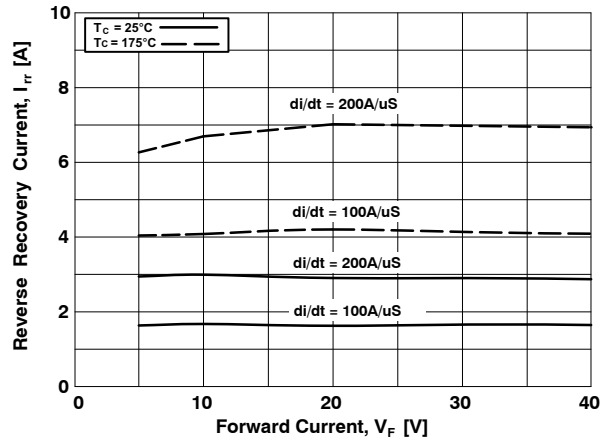

Figure 16. Reverse Recovery Current

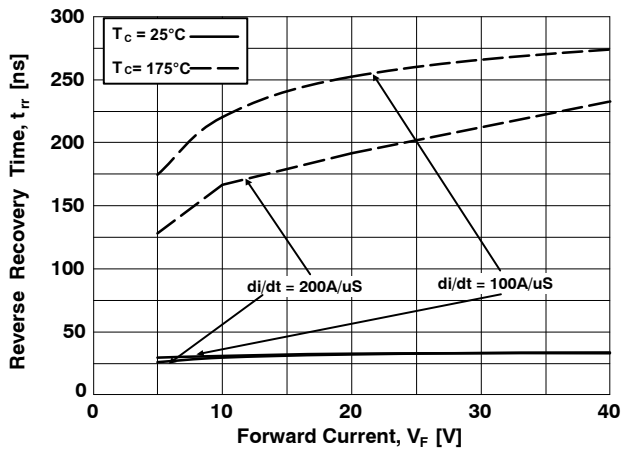

Figure 17. Reverse Recovery Time

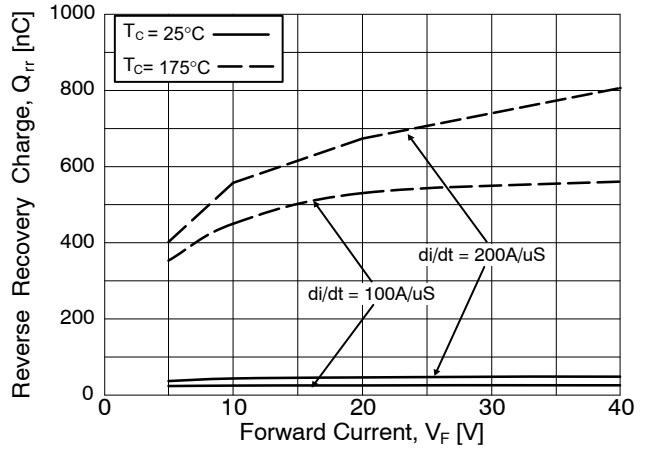

Figure 18. Stored Charge

FGHL40T65MQD

TYPICAL CHARACTERISTICS (continued)

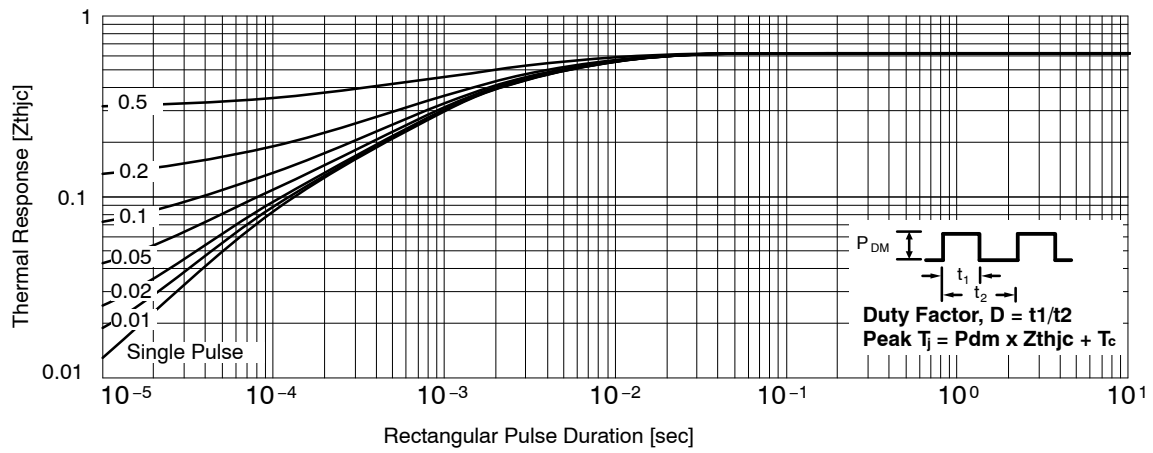

Figure 19. Transient Thermal Impedance of IGBT

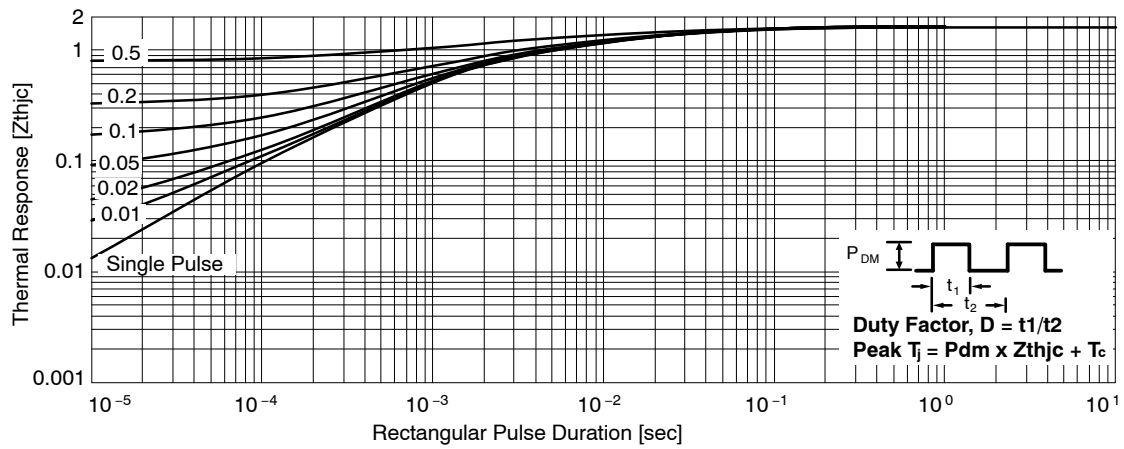

Figure 20. Transient Thermal Impedance of Diode

MECHANICAL CASE OUTLINE

PACKAGE DIMENSIONS

ON Semiconductor®



TO-247-3LD
CASE 340CX
ISSUE A

DATE 06 JUL 2020



NOTES: UNLESS OTHERWISE SPECIFIED.

- A. DIMENSIONS ARE EXCLUSIVE OF BURRS, MOLD FLASH, AND TIE BAR EXTRUSIONS.
- B. ALL DIMENSIONS ARE IN MILLIMETERS.
- C. DRAWING CONFORMS TO ASME Y14.5 - 2009.
- D. DIMENSION A1 TO BE MEASURED IN THE REGION DEFINED BY L1.
- E. LEAD FINISH IS UNCONTROLLED IN THE REGION DEFINED BY L1.

DIM	MILLIMETERS		
	MIN	NOM	MAX
A	4.58	4.70	4.82
A1	2.20	2.40	2.60
A2	1.40	1.50	1.60
D	20.32	20.57	20.82
E	15.37	15.62	15.87
E2	4.96	5.08	5.20
e	~	5.56	~
L	19.75	20.00	20.25
L1	3.69	3.81	3.93
∅P	3.51	3.58	3.65
Q	5.34	5.46	5.58
S	5.34	5.46	5.58
b	1.17	1.26	1.35
b2	1.53	1.65	1.77
b4	2.42	2.54	2.66
c	0.51	0.61	0.71
D1	13.08	~	~
D2	0.51	0.93	1.35
E1	12.81	~	~
∅P1	6.60	6.80	7.00

GENERIC MARKING DIAGRAM*



- XXXXX = Specific Device Code
- A = Assembly Location
- Y = Year
- WW = Work Week
- G = Pb-Free Package

*This information is generic. Please refer to device data sheet for actual part marking. Pb-Free indicator, "G" or microdot "▪", may or may not be present. Some products may not follow the Generic Marking.

DOCUMENT NUMBER:	98AON93302G	Electronic versions are uncontrolled except when accessed directly from the Document Repository. Printed versions are uncontrolled except when stamped "CONTROLLED COPY" in red.
DESCRIPTION:	TO-247-3LD	PAGE 1 OF 1

ON Semiconductor and are trademarks of Semiconductor Components Industries, LLC dba ON Semiconductor or its subsidiaries in the United States and/or other countries. ON Semiconductor reserves the right to make changes without further notice to any products herein. ON Semiconductor makes no warranty, representation or guarantee regarding the suitability of its products for any particular purpose, nor does ON Semiconductor assume any liability arising out of the application or use of any product or circuit, and specifically disclaims any and all liability, including without limitation special, consequential or incidental damages. ON Semiconductor does not convey any license under its patent rights nor the rights of others.

onsemi, **Onsemi**, and other names, marks, and brands are registered and/or common law trademarks of Semiconductor Components Industries, LLC dba "**onsemi**" or its affiliates and/or subsidiaries in the United States and/or other countries. **onsemi** owns the rights to a number of patents, trademarks, copyrights, trade secrets, and other intellectual property. A listing of **onsemi**'s product/patent coverage may be accessed at www.onsemi.com/site/pdf/Patent-Marking.pdf. **onsemi** reserves the right to make changes at any time to any products or information herein, without notice. The information herein is provided "as-is" and **onsemi** makes no warranty, representation or guarantee regarding the accuracy of the information, product features, availability, functionality, or suitability of its products for any particular purpose, nor does **onsemi** assume any liability arising out of the application or use of any product or circuit, and specifically disclaims any and all liability, including without limitation special, consequential or incidental damages. Buyer is responsible for its products and applications using **onsemi** products, including compliance with all laws, regulations and safety requirements or standards, regardless of any support or applications information provided by **onsemi**. "Typical" parameters which may be provided in **onsemi** data sheets and/or specifications can and do vary in different applications and actual performance may vary over time. All operating parameters, including "Typicals" must be validated for each customer application by customer's technical experts. **onsemi** does not convey any license under any of its intellectual property rights nor the rights of others. **onsemi** products are not designed, intended, or authorized for use as a critical component in life support systems or any FDA Class 3 medical devices or medical devices with a same or similar classification in a foreign jurisdiction or any devices intended for implantation in the human body. Should Buyer purchase or use **onsemi** products for any such unintended or unauthorized application, Buyer shall indemnify and hold **onsemi** and its officers, employees, subsidiaries, affiliates, and distributors harmless against all claims, costs, damages, and expenses, and reasonable attorney fees arising out of, directly or indirectly, any claim of personal injury or death associated with such unintended or unauthorized use, even if such claim alleges that **onsemi** was negligent regarding the design or manufacture of the part. **onsemi** is an Equal Opportunity/Affirmative Action Employer. This literature is subject to all applicable copyright laws and is not for resale in any manner.

ADDITIONAL INFORMATION

TECHNICAL PUBLICATIONS:

Technical Library: www.onsemi.com/design/resources/technical-documentation
onsemi Website: www.onsemi.com

ONLINE SUPPORT: www.onsemi.com/support

For additional information, please contact your local Sales Representative at www.onsemi.com/support/sales