

**Data sheet | Item number: 792-804**

Surge suppression module for signal technology; Nominal voltage: 48 VDC;  
for 2 signal paths with common surge arrester; for symmetric interfaces;  
Two-stage; Width: 6 mm; 2,50 mm<sup>2</sup>

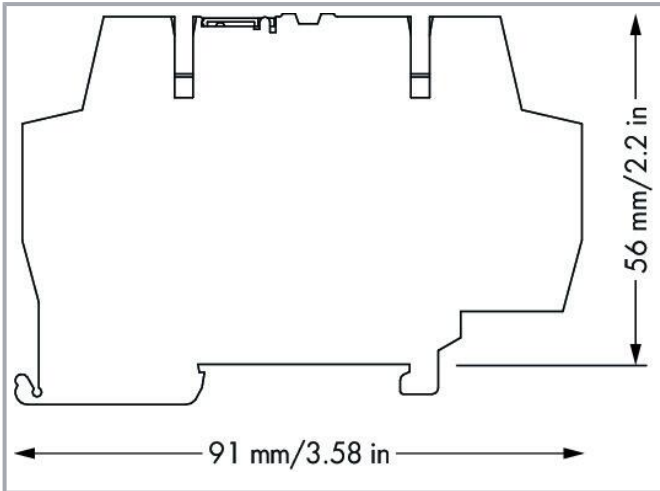

[www.wago.com/792-804](http://www.wago.com/792-804)

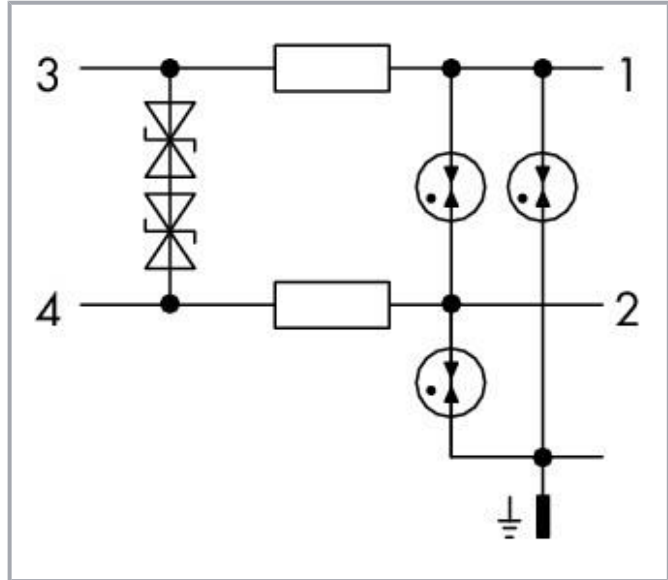
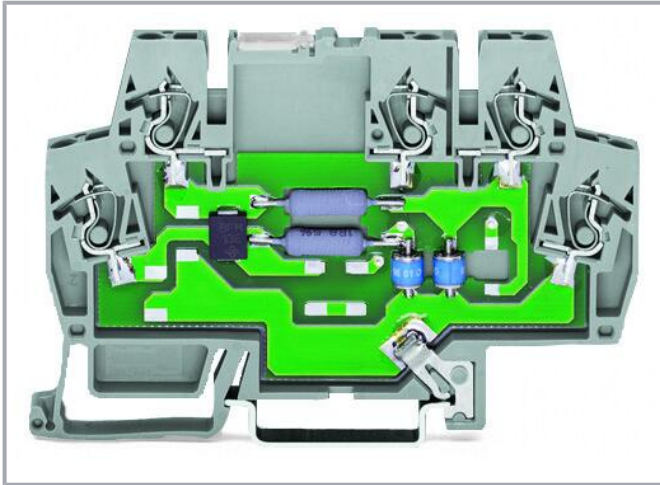

**Item description**

**Short description:**

Provides surge protection for IT systems and devices in the voltage range up to 60 V (except custom solutions, e.g., telephone systems with ringing voltage).

Subject to changes. Please also observe the further product documentation!

WAGO GmbH & Co. KG  
Hansastr. 27  
32423 Minden  
Phone: +49571 887-0 | Fax: +49571 887-169  
Email: [info.de@wago.com](mailto:info.de@wago.com) | Web: [www.wago.com](http://www.wago.com)

Do you have any questions about our products?  
We are always happy to take your call at +49 (571) 887-44222.



Overvoltage protection is also possible for DIN-35 rail-mount terminal blocks. Multi-stage surge arresters in rail-mount terminal blocks (792-80x Series) of just 6 mm width ensure cost-effective protection for control and bus technology (e.g., LON<sup>®</sup> network, PROFIBUS network, binary signals).

#### Features:

- Protect your system against overvoltage
- Slim, space-saving design
- Control operational costs by preventing expensive, unplanned downtime
- High operational reliability and system uptime

#### Data

#### Notes

Note	The coordination characteristics of the surge arrester provide information about its discharge capacity and protection capability.
------	--

#### Electrical data

Nominal operating voltage	DC 48 V
Highest continuous voltage	AC 38.5 V / DC 55 V
Nominal current	1.7 A
Nominal discharge current (8/20 μs) (line)	5 kA
Nominal discharge current (8/20 μs) (total)	10 kA
Protection level (line/line) (cat. C2 at $I_N$ )	≤ 100 V
Protection level (line/protected ground) (cat. C2 at $I_N$ )	≤ 750 V
Protection level (line/line) (cat. C3 at $I_N$ )	≤ 70 V
Protection level (line/protected ground) (cat. C3 at $I_N$ )	≤ 650 V
Limit frequency (line/line)	10 MHz
Impedance	0.4 Ω

#### Safety and protection

Protection type	IP00; IP20 with end and intermediate plate
-----------------	--

#### Connection data

Connections (number)	5
Connection technology	

Subject to changes. Please also observe the further product documentation!



	CAGE CLAMP®
Solid conductor	0.08 ... 2.5 mm <sup>2</sup> / 28 ... 14 AWG
Fine-stranded conductor	0.08 ... 2.5 mm <sup>2</sup> / 28 ... 14 AWG
Strip length	5 ... 6 mm / 0.2 ... 0.24 inches

### Physical data

Width	6 mm / 0.236 inches
Height from upper-edge of DIN-rail	56 mm / 2.205 inches
Depth	91 mm / 3.583 inches

### Mechanical Data

Mounting type	DIN-35 rail DIN-35 rail
---------------	----------------------------

### Material Data

Weight	37 g
--------	------

### Environmental requirements

Ambient temperature (operation)	-40 ... +80 °C
Ambient temperature (storage)	-40 ... +80 °C

### Standards and specifications

Standards/specifications	IEC 61643-21 IEC 61643-21
--------------------------	------------------------------

### Commercial data

Product Group	21 (Special Products Electronic)
eCl@ss 10.0	27-13-08-05
eCl@ss 9.0	27-13-08-05
ETIM 8.0	EC000943
ETIM 7.0	EC000943
PU (SPU)	1 pcs
Packaging type	Box
Country of origin	DE
GTIN	4017332780773
Customs tariff number	85363010900

Subject to changes. Please also observe the further product documentation!

WAGO GmbH & Co. KG  
Hansastr. 27  
32423 Minden  
Phone: +49571 887-0 | Fax: +49571 887-169  
Email: [info.de@wago.com](mailto:info.de@wago.com) | Web: [www.wago.com](http://www.wago.com)

Do you have any questions about our products?  
We are always happy to take your call at +49 (571) 887-44222.

## Environmental Product Compliance

RoHS Compliance Status

Compliant, No Exemption

## Approvals / Certificates

### General approvals

Logo	Approval	Additional Approval Text	Certificate name
	EAC Brjansker Zertifizierungsstelle	TP TC 004/2011	EAC RU C-DE.AM02. B.00122 /19

### Declarations of conformity and manufacturer's declarations

Logo	Approval	Additional Approval Text	Certificate name
	EU-Declaration of Conformity WAGO GmbH & Co. KG	-	-

## Optional accessories

### Tool

Operating tool



Item no.: 210-720

Operating tool; Blade: 3.5 x 0.5 mm; with a partially insulated shaft; multicoloured

[www.wago.com/210-720](http://www.wago.com/210-720)

### Marking accessories

Marking devices



Item no.: 210-110

Fiber-tip pen

[www.wago.com/210-110](http://www.wago.com/210-110)

Marker



Item no.: 2009-145

Mini-WSB Inline; for Smart Printer; 1700 pieces on roll; stretchable 5 - 5.2 mm; plain; snap-on type; white

[www.wago.com/2009-145](http://www.wago.com/2009-145)

Item no.: 248-451

Mini-WSB marking card; as card; MARKED; K11 - K20 (10x); not stretchable; Horizontal marking; snap-on type; white

[www.wago.com/248-451](http://www.wago.com/248-451)

Item no.: 248-455

Subject to changes. Please also observe the further product documentation!

WAGO GmbH &amp; Co. KG

Hansastr. 27









32423 Minden

Phone: +49571 887-0 | Fax: +49571 887-169

Email: [info.de@wago.com](mailto:info.de@wago.com) | Web: [www.wago.com](http://www.wago.com)

Do you have any questions about our products?

We are always happy to take your call at +49 (571) 887-44222.

	Mini-WSB marking card; as card; MARKED; U 100 (10x); not stretchable; Horizontal marking; snap-on type; white	<a href="http://www.wago.com/248-455">www.wago.com/248-455</a>
	<b>Item no.: 248-450</b> Mini-WSB marking card; as card; MARKED; K1 - K10 (10x); not stretchable; Horizontal marking; snap-on type; white	<a href="http://www.wago.com/248-450">www.wago.com/248-450</a>
	<b>Item no.: 248-452</b> Mini-WSB marking card; as card; MARKED; K (100x); not stretchable; Horizontal marking; snap-on type; white	<a href="http://www.wago.com/248-452">www.wago.com/248-452</a>
	<b>Item no.: 248-453</b> Mini-WSB marking card; as card; MARKED; U1, ... U10 (10x); not stretchable; Horizontal marking; snap-on type; white	<a href="http://www.wago.com/248-453">www.wago.com/248-453</a>
	<b>Item no.: 248-454</b> Mini-WSB marking card; as card; MARKED; U11 - U20 (10x); not stretchable; Horizontal marking; snap-on type; white	<a href="http://www.wago.com/248-454">www.wago.com/248-454</a>
	<b>Item no.: 248-566</b> Mini-WSB marking card; as card; MARKED; 1 ... 50 (2x); not stretchable; Horizontal marking; snap-on type; white	<a href="http://www.wago.com/248-566">www.wago.com/248-566</a>
	<b>Item no.: 248-501</b> Mini-WSB marking card; as card; not stretchable; plain; snap-on type; white	<a href="http://www.wago.com/248-501">www.wago.com/248-501</a>
	<b>Item no.: 248-504</b> Mini-WSB marking card; as card; MARKED; 21 ... 30 (10x); not stretchable; Horizontal marking; snap-on type; white	<a href="http://www.wago.com/248-504">www.wago.com/248-504</a>

#### End plate

Intermediate plate













	<b>Item no.: 859-525</b> End and intermediate plate; 1 mm thick; gray	<a href="http://www.wago.com/859-525">www.wago.com/859-525</a>
--	--	--

#### Jumpers















Jumper

	<b>Item no.: 859-408</b> Jumper; for jumper slot; 8-way; insulated; light gray	<a href="http://www.wago.com/859-408">www.wago.com/859-408</a>
	<b>Item no.: 859-404/000-005</b> Jumper; for jumper slot; 4-way; insulated; red	<a href="http://www.wago.com/859-404/000-005">www.wago.com/859-404/000-005</a>
	<b>Item no.: 859-404/000-006</b> Jumper; for jumper slot; 4-way; insulated; blue	<a href="http://www.wago.com/859-404/000-006">www.wago.com/859-404/000-006</a>
	<b>Item no.: 859-405/000-005</b> Jumper; for jumper slot; 5-way; insulated; red	<a href="http://www.wago.com/859-405/000-005">www.wago.com/859-405/000-005</a>

Subject to changes. Please also observe the further product documentation!

	<b>Item no.: 859-405/000-029</b> Jumper; for jumper slot; 5-way; insulated; yellow	<a href="http://www.wago.com/859-405/000-029">www.wago.com/859-405/000-029</a>
	<b>Item no.: 859-405</b> Jumper; for jumper slot; 5-way; insulated; light gray	<a href="http://www.wago.com/859-405">www.wago.com/859-405</a>
	<b>Item no.: 859-404/000-029</b> Jumper; for jumper slot; 4-way; insulated; yellow	<a href="http://www.wago.com/859-404/000-029">www.wago.com/859-404/000-029</a>
	<b>Item no.: 859-406</b> Jumper; for jumper slot; 6-way; insulated; light gray	<a href="http://www.wago.com/859-406">www.wago.com/859-406</a>
	<b>Item no.: 859-405/000-006</b> Jumper; for jumper slot; 5-way; insulated; blue	<a href="http://www.wago.com/859-405/000-006">www.wago.com/859-405/000-006</a>
	<b>Item no.: 859-406/000-005</b> Jumper; for jumper slot; 6-way; insulated; red	<a href="http://www.wago.com/859-406/000-005">www.wago.com/859-406/000-005</a>
	<b>Item no.: 859-409/000-029</b> Jumper; for jumper slot; 9-way; insulated; yellow	<a href="http://www.wago.com/859-409/000-029">www.wago.com/859-409/000-029</a>
	<b>Item no.: 859-410/000-005</b> Jumper; for jumper slot; 10-way; insulated; red	<a href="http://www.wago.com/859-410/000-005">www.wago.com/859-410/000-005</a>
	<b>Item no.: 859-410/000-029</b> Jumper; for jumper slot; 10-way; insulated; yellow	<a href="http://www.wago.com/859-410/000-029">www.wago.com/859-410/000-029</a>
	<b>Item no.: 859-410</b> Jumper; for jumper slot; 10-way; insulated; light gray	<a href="http://www.wago.com/859-410">www.wago.com/859-410</a>
	<b>Item no.: 859-410/000-006</b> Jumper; for jumper slot; 10-way; insulated; blue	<a href="http://www.wago.com/859-410/000-006">www.wago.com/859-410/000-006</a>
	<b>Item no.: 859-403/000-005</b> Jumper; for jumper slot; 3-way; insulated; red	<a href="http://www.wago.com/859-403/000-005">www.wago.com/859-403/000-005</a>
	<b>Item no.: 859-402/000-029</b> Jumper; for jumper slot; 2-way; insulated; yellow	<a href="http://www.wago.com/859-402/000-029">www.wago.com/859-402/000-029</a>

Subject to changes. Please also observe the further product documentation!

	<b>Item no.: 859-403/000-029</b> Jumper; for jumper slot; 3-way; insulated; yellow	<a href="http://www.wago.com/859-403/000-029">www.wago.com/859-403/000-029</a>
	<b>Item no.: 859-403/000-006</b> Jumper; for jumper slot; 3-way; insulated; blue	<a href="http://www.wago.com/859-403/000-006">www.wago.com/859-403/000-006</a>
	<b>Item no.: 859-408/000-005</b> Jumper; for jumper slot; 8-way; insulated; red	<a href="http://www.wago.com/859-408/000-005">www.wago.com/859-408/000-005</a>
	<b>Item no.: 859-408/000-029</b> Jumper; for jumper slot; 8-way; insulated; yellow	<a href="http://www.wago.com/859-408/000-029">www.wago.com/859-408/000-029</a>
	<b>Item no.: 859-409</b> Jumper; for jumper slot; 9-way; insulated; light gray	<a href="http://www.wago.com/859-409">www.wago.com/859-409</a>
	<b>Item no.: 859-408/000-006</b> Jumper; for jumper slot; 8-way; insulated; blue	<a href="http://www.wago.com/859-408/000-006">www.wago.com/859-408/000-006</a>
	<b>Item no.: 859-403</b> Jumper; for jumper slot; 3-way; insulated; light gray	<a href="http://www.wago.com/859-403">www.wago.com/859-403</a>
	<b>Item no.: 859-409/000-005</b> Jumper; for jumper slot; 9-way; insulated; red	<a href="http://www.wago.com/859-409/000-005">www.wago.com/859-409/000-005</a>
	<b>Item no.: 859-404</b> Jumper; for jumper slot; 4-way; insulated; light gray	<a href="http://www.wago.com/859-404">www.wago.com/859-404</a>
	<b>Item no.: 859-409/000-006</b> Jumper; for jumper slot; 9-way; insulated; blue	<a href="http://www.wago.com/859-409/000-006">www.wago.com/859-409/000-006</a>
	<b>Item no.: 859-402/000-006</b> Jumper; for jumper slot; 2-way; insulated; blue	<a href="http://www.wago.com/859-402/000-006">www.wago.com/859-402/000-006</a>
	<b>Item no.: 859-402</b> Jumper; for jumper slot; 2-way; insulated; light gray	<a href="http://www.wago.com/859-402">www.wago.com/859-402</a>
	<b>Item no.: 859-402/000-005</b> Jumper; for jumper slot; 2-way; insulated; red	<a href="http://www.wago.com/859-402/000-005">www.wago.com/859-402/000-005</a>
	<b>Item no.: 859-406/000-006</b> Jumper; for jumper slot; 6-way; insulated; blue	<a href="http://www.wago.com/859-406/000-006">www.wago.com/859-406/000-006</a>

Subject to changes. Please also observe the further product documentation!



**Item no.: 859-406/000-029**  
 Jumper; for jumper slot; 6-way; insulated; signal yellow

[www.wago.com/859-406/000-029](http://www.wago.com/859-406/000-029)



**Item no.: 859-407/000-006**  
 Jumper; for jumper slot; 7-way; insulated; blue

[www.wago.com/859-407/000-006](http://www.wago.com/859-407/000-006)



**Item no.: 859-407/000-005**  
 Jumper; for jumper slot; 7-way; insulated; red

[www.wago.com/859-407/000-005](http://www.wago.com/859-407/000-005)



**Item no.: 859-407/000-029**  
 Jumper; for jumper slot; 7-way; insulated; yellow

[www.wago.com/859-407/000-029](http://www.wago.com/859-407/000-029)



**Item no.: 859-407**  
 Jumper; for jumper slot; 7-way; insulated; light gray

[www.wago.com/859-407](http://www.wago.com/859-407)

## Downloads

### Documentation

#### Bid Text

792-804 X81 - Datei	2019 Feb 19	xml 4.5 kB	Download
792-804 doc - Datei	2015 Jul 23	doc 28.2 kB	Download

#### Additional Information

Disposal and Recycling Electrical and electronic equipment, Batteries, Packaging	V 1.1.0 2022 Aug 18	pdf 2.2 MB	Download
---	------------------------	---------------	----------

## CAD/CAE-Data

### CAE data

EPLAN Data Portal 792-804	URL	Download
WSCAD Universe 792-804	URL	Download
ZUKEN Portal 792-804	URL	Download

### CAD data

Subject to changes. Please also observe the further product documentation!





2D/3D Models 792-804

[URL](#)

[Download](#)

---

## Environmental Product Compliance

### Compliance Search

Environmental Product Compliance 792-804

[URL](#)

[Download](#)

Surge suppression module for signal technology; Nominal voltage: 48 VDC; for 2 signal paths with common surge arrester; for symmetric interfaces; Two-stage; Width: 6 mm; 2,50 mm<sup>2</sup>

---

## Installation Notes

Subject to changes. Please also observe the further product documentation!

---

WAGO GmbH & Co. KG

Hansastr. 27

32423 Minden

Phone: +49571 887-0 | Fax: +49571 887-169

Email: [info.de@wago.com](mailto:info.de@wago.com) | Web: [www.wago.com](http://www.wago.com)

Do you have any questions about our products?

We are always happy to take your call at +49 (571) 887-44222.