

## 2A, 200V - 1000V Fast Recovery Surface Mount Rectifier

### FEATURES

- Glass passivated chip junction
- Ideal for automated placement
- Low reverse leakage
- Moisture sensitivity level: level 1, per J-STD-020
- RoHS Compliant
- Halogen-free according to IEC 61249-2-21

### APPLICATIONS

- DC to DC converter
- Switching mode converters and inverters
- General purpose

### MECHANICAL DATA

- Case: SOD-123FL
- Molding compound meets UL 94V-0 flammability rating
- Terminal: Matte tin plated leads, solderable per J-STD-002
- Meet JESD 201 class 1 whisker test
- Polarity: Indicated by cathode band
- Weight: 0.016g (approximately)

KEY PARAMETERS		
PARAMETER	VALUE	UNIT
$I_F$	2	A
$V_{RRM}$	200 - 1000	V
$I_{FSM}$	40	A
$T_{JMAX}$	150	°C
Package	SOD-123FL	
Configuration	Single die	



SOD-123FL



ABSOLUTE MAXIMUM RATINGS ( $T_A = 25^\circ\text{C}$ unless otherwise noted)								
PARAMETER	SYMBOL	RS2DFL	RS2GFL	RS2JFL	RS2KFL	RS2MFL	UNIT	
Marking code on the device		R2DF	R2GF	R2JF	R2KF	R2MF		
Repetitive peak reverse voltage	$V_{RRM}$	200	400	600	800	1000	V	
Reverse voltage, total rms value	$V_{R(RMS)}$	140	280	420	560	700	V	
Forward current	$I_F$	2					A	
Surge peak forward current, single half sine-wave superimposed on rated load	$t = 8.3\text{ms}$	$I_{FSM}$					40	A
	$t = 1.0\text{ms}$						100	A
Junction temperature	$T_J$	-55 to +150					°C	
Storage temperature	$T_{STG}$	-55 to +150					°C	

<b>THERMAL PERFORMANCE</b>			
<b>PARAMETER</b>	<b>SYMBOL</b>	<b>TYP</b>	<b>UNIT</b>
Junction-to-lead thermal resistance	$R_{\theta JL}$	81	°C/W
Junction-to-ambient thermal resistance	$R_{\theta JA}$	116	°C/W
Junction-to-case thermal resistance	$R_{\theta JC}$	69	°C/W

**Thermal Performance Note:** Units mounted on PCB (5mm x 5mm Cu pad test board)

<b>ELECTRICAL SPECIFICATIONS</b> ( $T_A = 25^\circ\text{C}$ unless otherwise noted)						
<b>PARAMETER</b>		<b>CONDITIONS</b>	<b>SYMBOL</b>	<b>TYP</b>	<b>MAX</b>	<b>UNIT</b>
Forward voltage <sup>(1)</sup>	RS2DFL RS2GFL	$I_F = 1\text{A}, T_J = 25^\circ\text{C}$	$V_F$	0.86	-	V
		$I_F = 2\text{A}, T_J = 25^\circ\text{C}$		0.94	1.30	V
		$I_F = 1\text{A}, T_J = 125^\circ\text{C}$		0.75	-	V
		$I_F = 2\text{A}, T_J = 125^\circ\text{C}$		0.84	0.99	V
	RS2JFL RS2KFL RS2MFL	$I_F = 1\text{A}, T_J = 25^\circ\text{C}$	$V_F$	0.98	-	V
		$I_F = 2\text{A}, T_J = 25^\circ\text{C}$		1.09	1.30	V
		$I_F = 1\text{A}, T_J = 125^\circ\text{C}$		0.89	-	V
		$I_F = 2\text{A}, T_J = 125^\circ\text{C}$		1.02	1.20	V
Reverse current @ rated $V_R$ <sup>(2)</sup>		$T_J = 25^\circ\text{C}$	$I_R$	-	5	$\mu\text{A}$
		$T_J = 125^\circ\text{C}$		-	150	$\mu\text{A}$
Reverse recovery time	RS2DFL RS2GFL	$I_F = 0.5\text{A}, I_R = 1.0\text{A}, I_{rr} = 0.25\text{A}$	$t_{rr}$	-	150	ns
	RS2JFL RS2KFL RS2MFL			-	250	ns
Junction capacitance	RS2DFL RS2GFL	1MHz, $V_R = 4.0\text{V}$	$C_J$	16	-	pF
	RS2JFL RS2KFL RS2MFL			9	-	pF

**Notes:**

1. Pulse test with PW = 0.3ms
2. Pulse test with PW = 30ms

<b>ORDERING INFORMATION</b>		
<b>ORDERING CODE<sup>(1)</sup></b>	<b>PACKAGE</b>	<b>PACKING</b>
RS2xFL	SOD-123FL	10,000 / Tape & Reel

**Notes:**

1. "x" defines voltage from 200V(RS2DFL) to 1000V(RS2MFL)

**CHARACTERISTICS CURVES**

( $T_A = 25^\circ\text{C}$  unless otherwise noted)

**Fig.1 Forward Current Derating Curve**

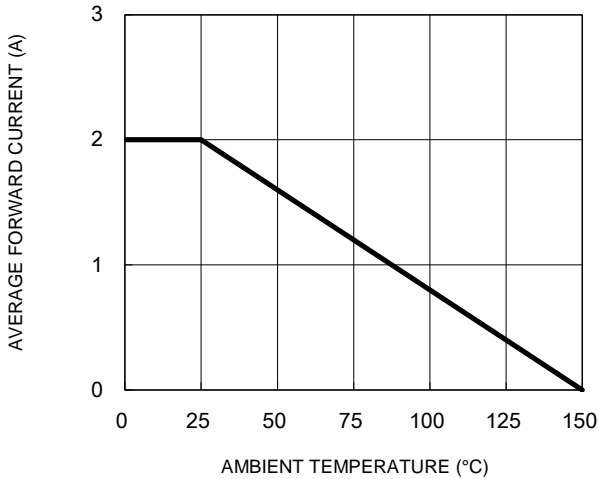

**Fig.2 Typical Junction Capacitance**

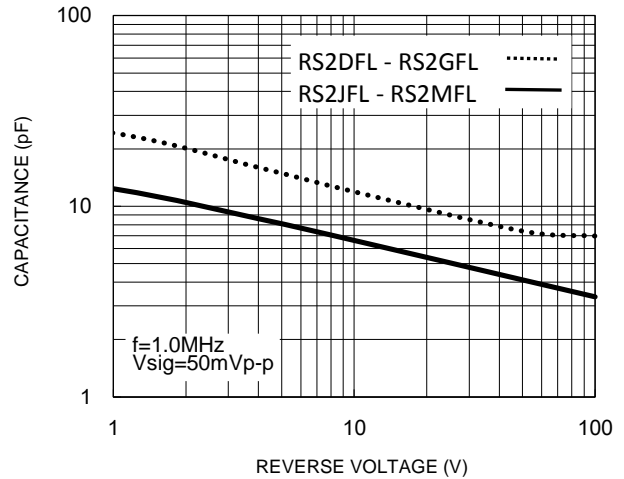

**Fig.3 Typical Reverse Characteristics**

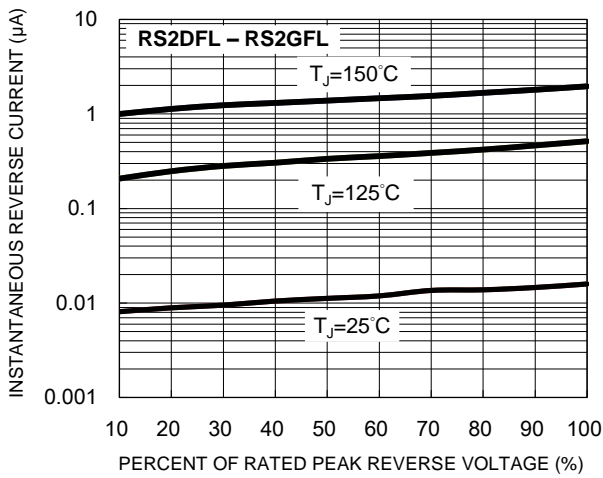

**Fig.4 Typical Forward Characteristics**

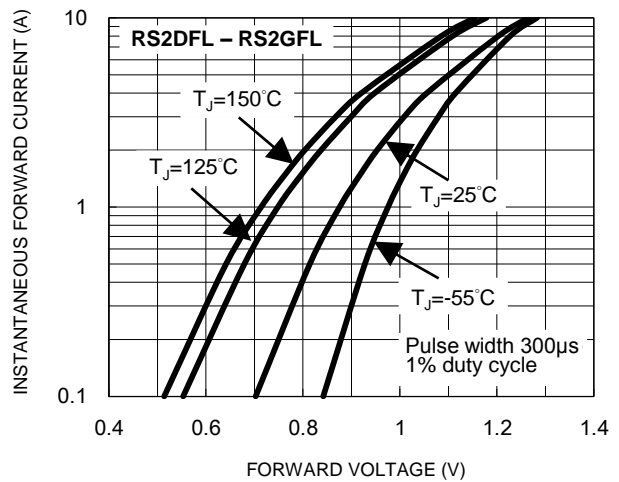

**Fig.5 Typical Reverse Characteristics**

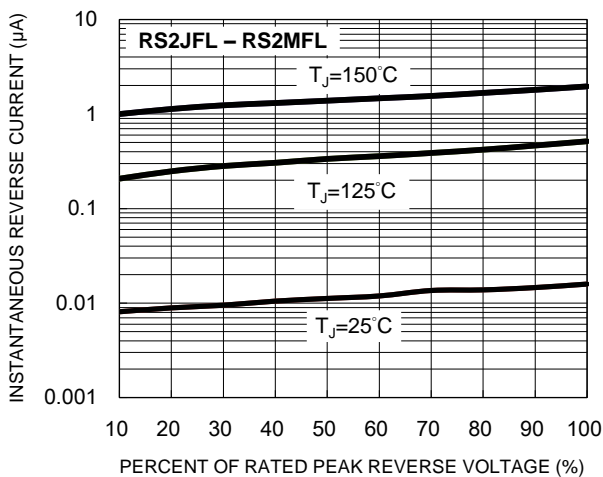

**Fig.6 Typical Forward Characteristics**

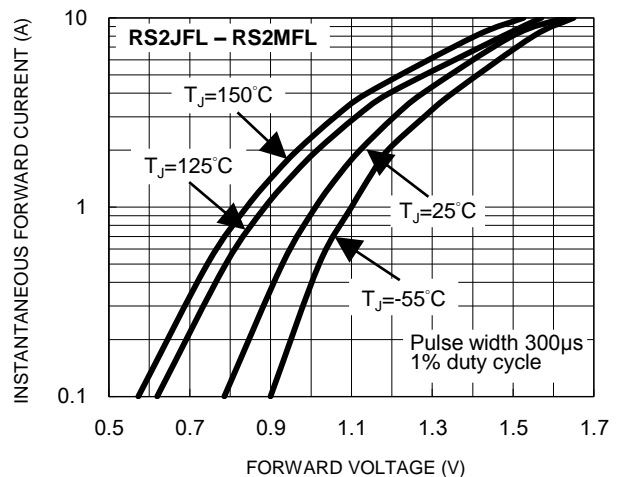

**CHARACTERISTICS CURVES**

( $T_A = 25^\circ\text{C}$  unless otherwise noted)

**Fig.7 Typical Transient Thermal Impedance**

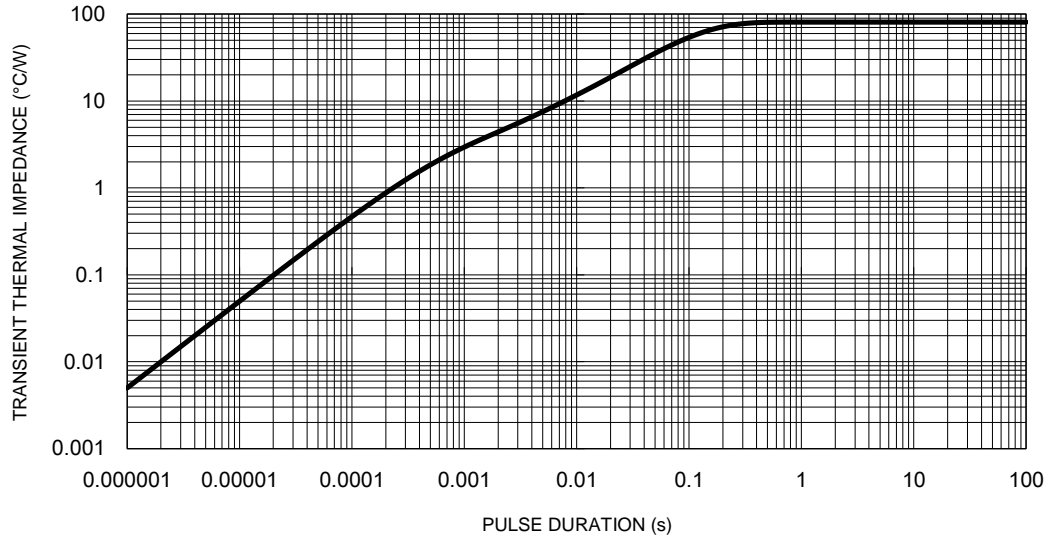

**PACKAGE OUTLINE DIMENSIONS**

SOD-123FL

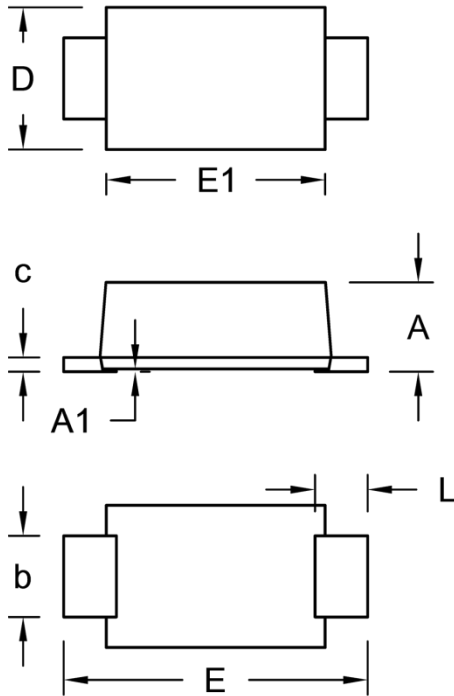

DIM.	Unit (mm)		Unit (inch)	
	Min.	Max.	Min.	Max.
A	1.00	1.20	0.039	0.047
A1	0.02	0.05	0.001	0.002
b	0.90	1.10	0.035	0.043
c	0.10	0.25	0.004	0.010
D	1.60	1.90	0.063	0.075
E	3.60	3.90	0.142	0.154
E1	2.55	2.85	0.100	0.112
L	0.40	0.90	0.016	0.035

**SUGGESTED PAD LAYOUT**

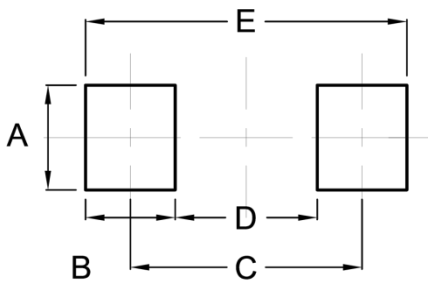

Symbol	Unit (mm)	Unit (inch)
A	1.40	0.055
B	1.20	0.047
C	3.10	0.122
D	1.90	0.075
E	4.30	0.169

**MARKING DIAGRAM**



P/N = Marking Code  
 YW = Date Code  
 F = Factory Code

## **Notice**

Specifications of the products displayed herein are subject to change without notice. TSC or anyone on its behalf, assumes no responsibility or liability for any errors or inaccuracies.

Purchasers are solely responsible for the choice, selection, and use of TSC products and TSC assumes no liability for application assistance or the design of Purchasers' products.

Information contained herein is intended to provide a product description only. No license, express or implied, to any intellectual property rights is granted by this document. Except as provided in TSC's terms and conditions of sale for such products, TSC assumes no liability whatsoever, and disclaims any express or implied warranty, relating to sale and/or use of TSC products including liability or warranties relating to fitness for a particular purpose, merchantability, or infringement of any patent, copyright, or other intellectual property right.

The products shown herein are not designed for use in medical, life-saving, or life-sustaining applications. Customers using or selling these products for use in such applications do so at their own risk and agree to fully indemnify TSC for any damages resulting from such improper use or sale.