

User Manual

IDP31-190 Series 19" Industrial ProFlat Projected Capacitive Touch Monitor



Copyright

The documentation and the software included with this product are copyrighted 2016 by Advantech Co., Ltd. All rights are reserved.

Advantech Co., Ltd. reserves the right to make improvements in the products described in this manual at any time without notice. No part of this manual may be reproduced, copied, translated or transmitted in any form or by any means without the prior written permission of Advantech Co., Ltd. Information provided in this manual is intended to be accurate and reliable. However, Advantech Co., Ltd. assumes no responsibility for its use, nor for any infringements of the rights of third parties, which may result from its use.

Acknowledgements

Intel and Pentium are trademarks of Intel Corporation.

Microsoft Windows and MS-DOS are registered trademarks of Microsoft Corp.

All other product names or trademarks are properties of their respective owners.

Product Warranty (2 year)

Advantech warrants to you, the original purchaser, that each of its products will be free from defects in materials and workmanship for two years from the date of purchase. This warranty does not apply to any products which have been repaired or altered by persons other than repair personnel authorized by Advantech, or which have been subject to misuse, abuse, accident or improper installation. Advantech assumes no liability under the terms of this warranty as a consequence of such events.

Because of Advantech's high quality-control standards and rigorous testing, most of our customers never need to use our repair service. If an Advantech product is defective, it will be repaired or replaced at no charge during the warranty period. For out of-warranty repairs, you will be billed according to the cost of replacement materials, service time and freight. Please consult your dealer for more details.

If you think you have a defective product, follow these steps:

1. Collect all the information about the problem encountered. (For example, CPU speed, Advantech products used, other hardware and software used, etc.) Note anything abnormal and list any onscreen messages you get when the problem occurs.
2. Call your dealer and describe the problem. Please have your manual, product, and any helpful information readily available.
3. If your product is diagnosed as defective, obtain an RMA (return merchandise authorization) number from your dealer. This allows us to process your return more quickly.
4. Carefully pack the defective product, a fully-completed Repair and Replacement Order Card and a photocopy proof of purchase date (such as your sales receipt) in a shippable container. A product returned without proof of the purchase date is not eligible for warranty service.
5. Write the RMA number visibly on the outside of the package and ship it prepaid to your dealer.

Declaration of Conformity

CE

This product has passed the CE test for environmental specifications. Test conditions for passing included the equipment being operated within an industrial enclosure. In order to protect the product from being damaged by ESD (Electrostatic Discharge) and EMI leakage, we strongly recommend the use of CE-compliant industrial enclosure products.

FCC Class A

This equipment has been tested and found to comply with the limits for a Class A digital device, pursuant to part 15 of the FCC Rules. These limits are designed to provide reasonable protection against harmful interference when the equipment is operated in a commercial environment. This equipment generates, uses, and can radiate radio frequency energy and, if not installed and used in accordance with the instruction manual, may cause harmful interference to radio communications. Operation of this equipment in a residential area is likely to cause harmful interference in which case the user will be required to correct the interference at his own expense..

FM

This equipment has passed the FM certification. According to the National Fire Protection Association, work sites are classified into different classes, divisions and groups, based on hazard considerations. This equipment is compliant with the specifications of Class I, Division 2, Groups A, B, C and D indoor hazards.

Technical Support and Assistance

1. Visit the Advantech website at <http://www.advantech.com> where you can find the latest information about the product.
2. Contact your distributor, sales representative, or advantech's customer service center for technical support if you need additional assistance. Please have the following information ready before you call:
 - Product name and serial number
 - Description of your peripheral attachments
 - Description of your software (operating system, version, application software, etc.)
 - A complete description of the problem
 - The exact wording of any error messages

Warnings, Cautions and Notes

Warning! Warnings indicate conditions, which if not observed, can cause personal injury!



Caution! Cautions are included to help you avoid damaging hardware or losing data. e.g.

There is a danger of a new battery exploding if it is incorrectly installed. Do not attempt to recharge, force open, or heat the battery. Replace the battery only with the same or equivalent type recommended by the manufacturer. Discard used batteries according to the manufacturer's instructions...



Note! Notes provide optional additional information.



Document Feedback

To assist us in making improvements to this manual, we would welcome comments and constructive criticism. Please send all such - in writing to :
support@advantech.com

Safety Instructions

1. Read these safety instructions carefully.
2. Keep this User Manual for later reference.
3. Disconnect this equipment from any AC outlet before cleaning. Use a damp cloth. Do not use liquid or spray detergents for cleaning.
4. For plug-in equipment, the power outlet socket must be located near the equipment and must be easily accessible.
5. Keep this equipment away from humidity.
6. Put this equipment on a reliable surface during installation. Dropping it or letting it fall may cause damage.
7. The openings on the enclosure are for air convection. Protect the equipment from overheating. **DO NOT COVER THE OPENINGS.**
8. Make sure the voltage of the power source is correct before connecting the equipment to the power outlet.
9. Position the power cord so that people cannot step on it. Do not place anything over the power cord.
10. All cautions and warnings on the equipment should be noted.
11. If the equipment is not used for a long time, disconnect it from the power source to avoid damage by transient overvoltage.
12. Never pour any liquid into an opening. This may cause fire or electrical shock.
13. Never open the equipment. For safety reasons, the equipment should be opened only by qualified service personnel.
14. If one of the following situations arises, get the equipment checked by service personnel:
 - The power cord or plug is damaged.
 - Liquid has penetrated into the equipment.
 - The equipment has been exposed to moisture.
 - The equipment does not work well, or you cannot get it to work according to the user's manual.
 - The equipment has been dropped and damaged.
 - The equipment has obvious signs of breakage.
15. **DO NOT LEAVE THIS EQUIPMENT IN AN ENVIRONMENT WHERE THE STORAGE TEMPERATURE MAY GO BELOW -30° C OR ABOVE 85° C. THIS COULD DAMAGE THE EQUIPMENT. THE EQUIPMENT SHOULD BE IN A CONTROLLED ENVIRONMENT.**
16. **CAUTION: DANGER OF EXPLOSION IF BATTERY IS INCORRECTLY REPLACED. REPLACE ONLY WITH THE SAME OR EQUIVALENT TYPE RECOMMENDED BY THE MANUFACTURER, DISCARD USED BATTERIES ACCORDING TO THE MANUFACTURER'S INSTRUCTIONS.**
The sound pressure level at the operator's position according to IEC 704-1:1982 is no more than 70 dB (A).
DISCLAIMER: This set of instructions is given according to IEC 704-1. Advantech disclaims all responsibility for the accuracy of any statements contained herein.

Caution! *For power adapter selection: the information about the adapter output rating (12 Vdc, 3.5A min) is provided in the user manual for user's selection if the power adapter is not shipped with the unit*



Contents

Chapter 1 Overview.....	1
1.1 Introduction.....	2
1.2 Features.....	2
1.3 Applications.....	2
1.4 Product Photos.....	2,3
1.5 Naming Rule.....	4
Chapter 2 System Setup.....	5
2.1 Specifications.....	6
2.2 Dimensions.....	7
Figure 2.1 IDP31-190 Series Dimensions.....	7
2.3 Rear Mount Assembly SOP.....	7
2.4 Packing List.....	8
Chapter 3 Touchscreen.....	9
3.1 OSD Functions (IDP31-190 Series)	10
3.1.1 OSD Main Menu : PICTURE.....	10
3.1.2 OSD Main Menu : COLOR	11
3.1.3 OSD Main Menu : OSD.....	11
3.1.4 OSD Main Menu : SETUP.....	12
3.2 Touch Drivers.....	12
Chapter 4 Troubleshooting.....	13
A.1 Introduction.....	14
A.2 Troubleshooting.....	14

Chapter 1

Overview

Sections include :

- ◆ Introduction
- ◆ Features
- ◆ Applications
- ◆ Product Photos
- ◆ Naming Rule

1.1 Introduction

The Advantech IDP31-190 series is a brand new Industrial Proflat Monitor, designed to meet the needs of customers who want quick and easy integration with Advantech Embedded Box Computers, such as ARK and DSA lines. Advantech offers two different colour versions of IDP31-190 to meet different demands: IDP31-190 series

1.2 Features

- ◆ 19" LED backlight panel provides 20~30% power saving
- ◆ -10°C ~ +70°C wide operating temperature support
- ◆ Special design of the Projected Capacitive touchscreen
- ◆ The all new mechanical design with integrated bracket for easy installation
- ◆ Versatile mounting methods for rear mount and VESA mount
- ◆ (100 x 100 mm)

1.3 Applications

Application scenarios - self-service applications:

- ◆ KIOSK / POI machine
- ◆ Transportation machine
- ◆ Ticketing machine
- ◆ Financial ATM
- ◆ Entertainment / Gaming / Slot machine
- ◆ HMI (Human-Machine Interface) equipment controller monitor
- ◆ Public communication machine
- ◆ Public advertisement machine

1.4 Product Photos

Front view

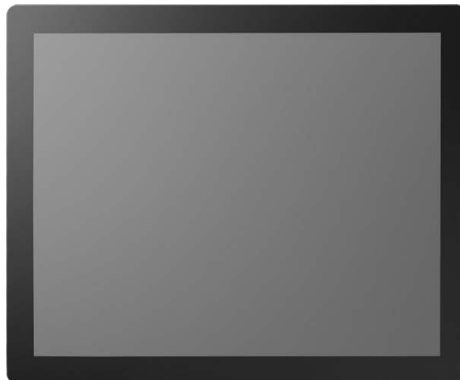

Rear view



Bottom view



1.5 Naming Rule

IDP 3 1 – 104 W R 40 DP A1E

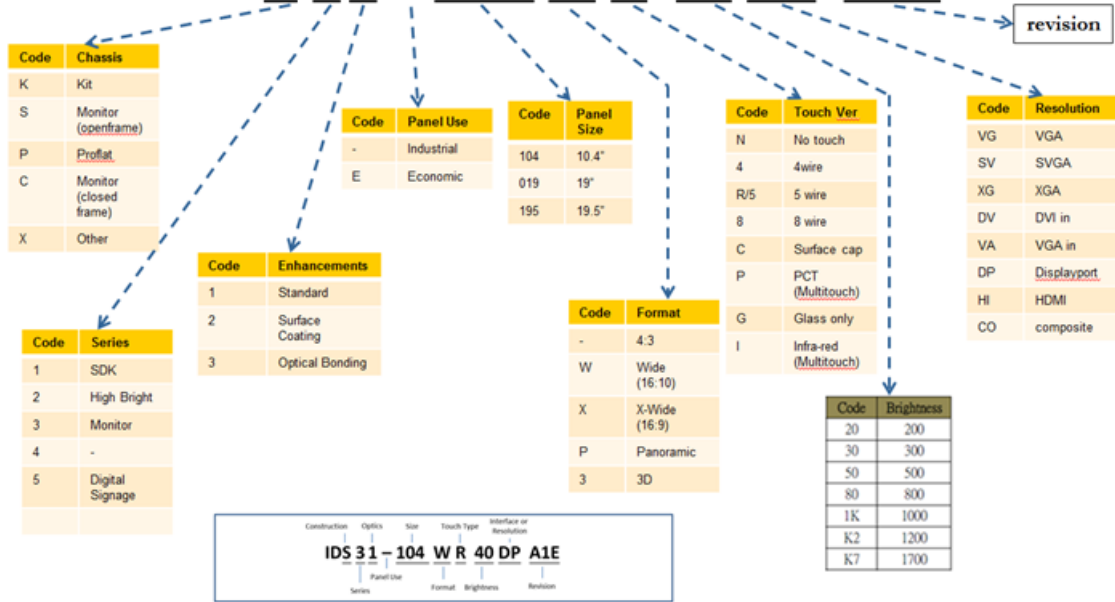

Chapter 2

System Setup

Sections include :

- ◆ Specifications
- ◆ Dimensions
- ◆ Rear Mount Assembly SOP
- ◆ Cable Clamp
- ◆ Accessory Packing

2.1 Specifications

Note!

The IDP31-190 series offers the following features and meets precise specifications.



Unless otherwise noted, all the information listed below is subject to change without prior notification.

	Model	IDP31-190 series
Display	Size	19" LED Panel
	Resolution	1280 X 1024
	Viewing Angle	85° /85° (H), 80° /80° (V)
	Brightness	350 (cd/m2)
	Contrast Ratio	1,000 : 1
	Response Time	10 [msec] (Raising + Falling)
	Display Mode	TN, Normally White
	Surface Treatment	Anti-glare, Hardness 3H
	Color Support	16.7M colors (RGB 8 bits + Hi_FRC)
	Backlight Life	50,000 hrs
Touch	Projected Capacitive	Touch Screen
Input Signal	VGA,DVI,HDMI	VGA x 1; DVI-D x 1; HDMI x 1, VDC Jack x 1; USB x1; RS-232 x 1 (USB & RS-232 are reserved for the connection to enable touch usage only)
Power Consumption	Power	18 Watt Power adapter, with AC 100 ~ 240 V input and DC +12 V @ 3.5A output.
Environment	Operating Temperature	-10 ~ +70° C
	Storage Temperature	-30 ~ +85° C
	Humidity	50° C / 80%
	Vibration	1.5G, (10~200Hz, P-P) 30 mins/axis (X, Y, Z)
	EMC Compliance	CE/FCC/RoHS

2.2 Dimensions

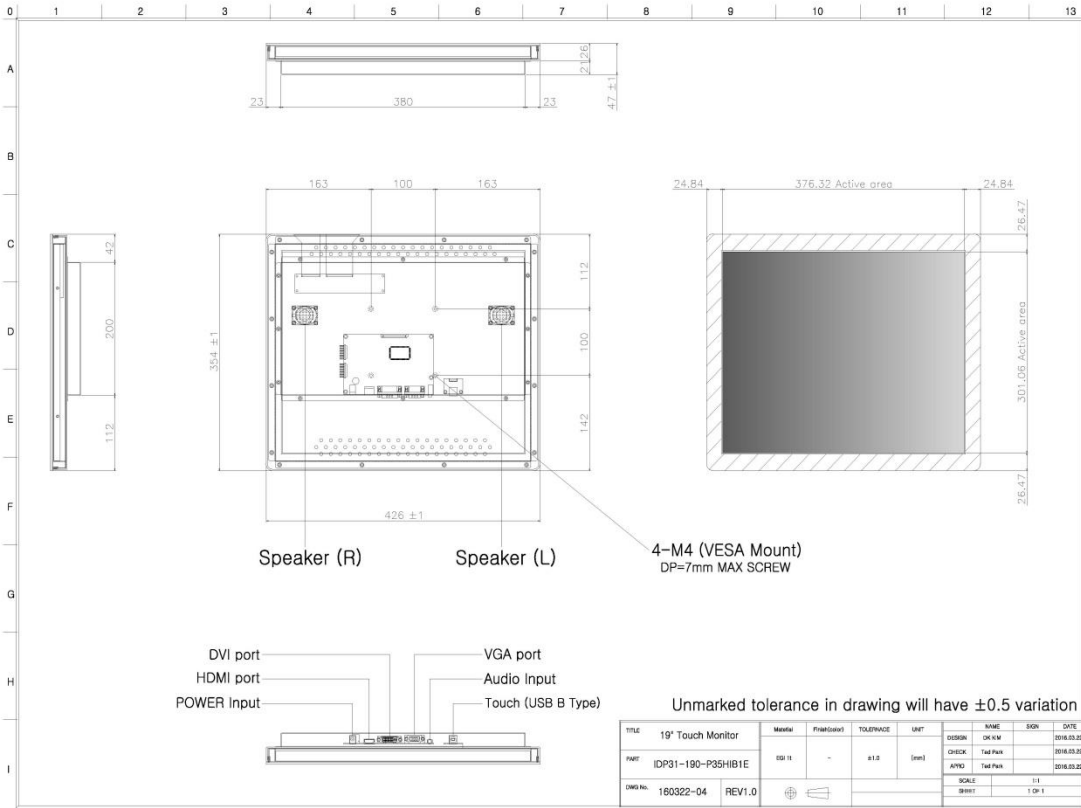

2.3 Rear Mount Assembly SOP

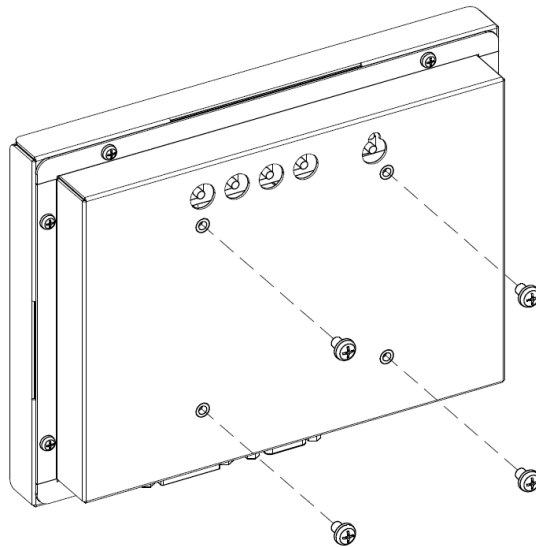

2.4 Packing List

- ◆ 1 x VGA cable 15P 1.8 meter
- ◆ 1 x DVI Cable 24P 1.5 meter
- ◆ 1 x HDMI Cable 1.5 meter
- ◆ 1 x USB-A to USB-B 1.8 meter
- ◆ 1 x Power Cord 1.8 meter
- ◆ 1 x DC 12V/3.5A Power Adapter
- ◆ 1 x CD-ROM for IDP31-190 Series

Note!



Above accessory cables are subject to change in different Replacement.

Chapter 3

Touchscreen

Sections include :

- ◆ OSD Functions
- ◆ Touch Drivers

3.1 OSD Functions (IDP31-190 Series)

The OSD of the IDP31-190 Series display (1280 x 1024 resolution) was selected to illustrate examples below:

Button	Function	Status	HOT Key
LED	Indicates operation status	Green : Normal Operation Red : Off Mode Amber : No valid input, No Signal Green Blinking : Sleep mode	-
POWER	Turn on or turn off the power		
MENU	Display the OSD menu on no menu status Exit a menu of sub-menu		
SELECT	Select highlighted function		Input Source Change on no menu status
DOWN	Select previous menu item Decrease slider value		Auto Configuration on no menu status
UP	Select next menu item Increase slider value		Auto Color on no menu status

3.1.1 OSD Main Menu: PICTURE

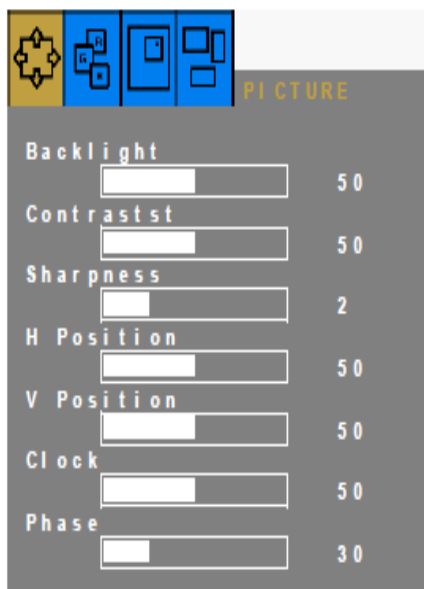

ITEM	Sub Menu	Description	Value	
Picture	Brightness	Adjust the backlight level of screen	50(0~100)	
	Contrast	Increase/ decrease picture contrast	50(0~100)	
	Sharpness	Control the clarity of details of pictures	2(0~4)	
	H Position	Adjust picture horizontal position	50(0~100)	RGB ONLY
	V Position	Adjust picture vertical position	50(0~100)	
	Clock	Adjust picture width	50(0~100)	
	Phase	Adjust picture focus quality	30(0~100)	

3.1.2 OSD Main Menu: COLOR

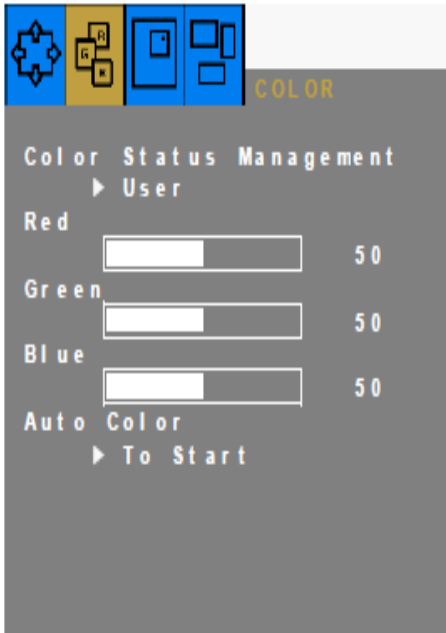

Color	Color Status Management	Select the color of picture mode	User(User, Warm, Normal, Cool)	
	Red	Adjust color of red rate	50(0~100)	RGB ONLY
	Green	Adjust color of green rate	50(0~100)	
	Blue	Adjust color of blue rate	50(0~100)	
	Auto Color	Auto color calibration	To Start	

3.1.3 OSD Main Menu: OSD

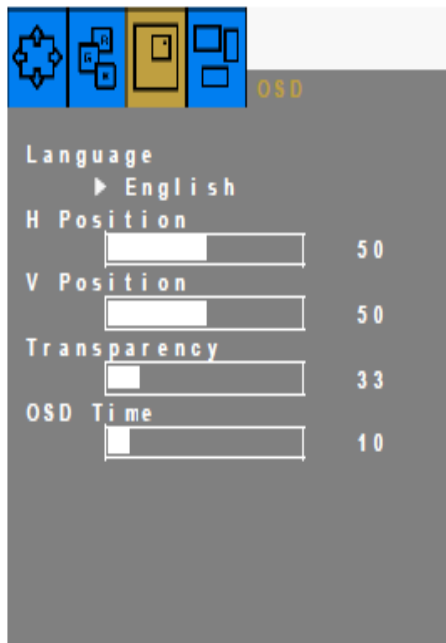

OSD	Language	Select OSD menu language	English(English, Deutsh, Francais, Italiano, Espanol, Korean)	
	H Position	Adjust the OSD horizontal position	50(0~100)	
	V Position	Adjust the OSD vertical position	50(0~100)	
	Transparency	Select the transparency of the OSD	33 (0~100)	
	OSD Time	Adjust the OSD menu timeout	10(3~30)	

3.1.4 OSD Main Menu: SETUP

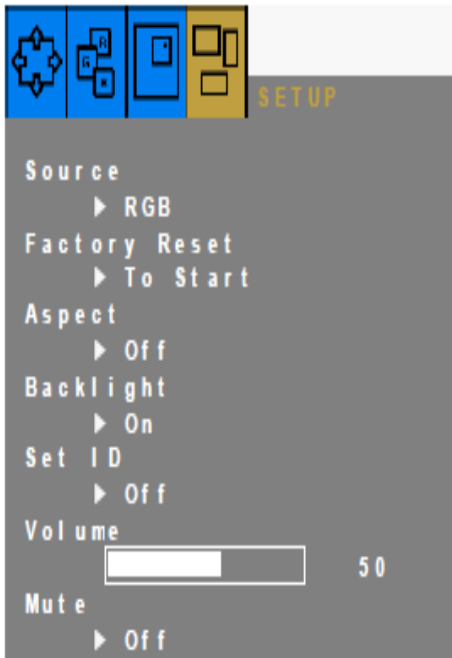

SETUP	Source	Select the input signal Source	RGB, DVI, AUTO	
	Factory reset	Reset to factory settings	To Start	
	Aspect	On/ Off the fit to screen	Off(On/Off)	
	Backlight DIM	On/ Off the backlight Dimming(PWM)	Off(On/Off)	
	Set ID	On/ Off the RS232 control	Off(On/Off)	Optional
	Volume	Adjust the audio volume	62(0~100)	Optional
	Mute	On/ Off the audio output	Off(On/Off)	Optional

3.2 Touch Drivers

It is available online at the Advantech website as follows:

www.advantech.com/products

Appendix A

Troubleshooting

A.1 Introduction

If experiencing trouble with the monitor, or it fails to operate correctly, please refer to the following instructions before calling the Advantech service center. If unable to correct the faults using the instructions below, then please contact the distributor or the services/repair center.

A.2 Troubleshooting

No Images Appears On Screen

- ◆ Check to see that all the I/O and power connectors are installed correctly and connected. (Refer to 1.4, ProFlat Bottom view)
- ◆ Make sure that none of the connectors are crooked, broken or loose.
- ◆ Make sure that the OSD power on the LED is turned on.
- ◆ Make sure that the brightness is not in the minimum.
- ◆ Make sure that the screen resolution is set to the correct setting for the type of LCD, and that the setting does not exceed the resolution specified for the particular model of LCD.

The image is incorrectly displayed, or the full screen image does not appear

- ◆ Please make sure the screen resolution on the motherboard is correct.

The position of screen is not in the center

- ◆ Adjust the H-position and V-position or perform "Auto".

Out of range

- ◆ When the message "Out of Range" appears onscreen, it indicates that the signal of the computer is not compatible with the LCD display; i.e. the resolution exceeds the specified resolution for the LCD.
- ◆ Adjust the BIOS setting to match the correct resolution.

No signal

- ◆ The display is powered on, but can neither receive or display any signal from the computer. Check all power switches, power cables and I/O signal cables to ensure that all are connected correctly on both sides.

Going to sleep

- ◆ If the system goes to sleep, then the display has either been set to power-saving mode, or the display is experiencing a sudden signal disconnection problem. Check the BIOS system settings, and/or Windows configuration. Then check the connection of the power cable to computer on both sides.

www.advantech.com

Please verify specifications before quoting. This guide is intended for reference purposes only. All product specifications are subject to change without notice. No part of this publication may be reproduced in any form or by any means, electronic, photocopying, recording or otherwise, without prior written permission of the publisher.

All brand and product names are trademarks or registered trademarks of their respective companies.

© Advantech Co., Ltd. 2016