

**Pb-free  
HEAT**



# 1114C-0005 Series

Single Color 1608 (h=0.4 mm) Type

## Features

Package	1608 (h=0.4mm) Type, Milky White resin
Product features	<ul style="list-style-type: none"> <li>▪ Outer Dimension 1.6 x 0.8 x 0.4mm ( L x W x H )</li> <li>▪ Temperature range Storage Temperature : -40°C~100°C Operating Temperature : -40°C~ 85°C</li> <li>▪ Lead-free soldering compatible</li> <li>▪ RoHS compliant</li> </ul>
Dominant wavelength	Yellow Green : 572nm(YPY) Yellow : 590nm(FY) Orange : 605nm(FA) Red : 626nm(FR)
Spatial distribution	$\theta_x = 130 \text{ deg.}, \theta_y = 150 \text{ deg.}$
Die materials	AlGaInP
Rank grouping parameter	Sorted by luminous intensity and wavelength per rank taping
Assembly method	Auto pick & place machine (Auto Mounter)
Soldering methods	Reflow soldering and manual soldering
Taping and reel	4,000pcs per reel in a 8mm width tape. (Standard) Reel diameter: $\phi 180\text{mm}$
ESD	1kV (HBM)

## Recommended Applications

Cellular Phone only

## Color and Luminous Intensity

(Ta=25°C)

Part No.	Material	Emitted Color	Lens Color	Dominant Wavelength		Luminous Intensity		
				$\lambda d$ (nm)		Iv (mcd)		
				TYP.	I <sub>F</sub>	MIN.	TYP.	I <sub>F</sub>
YPY1114C-0005	AlGaInP	Yellow Green	Milky White	572	5	4.0	10	5
FY1114C-0005	AlGaInP	Yellow		590	5	6.3	16	5
FA1114C-0005	AlGaInP	Orange		605	5	6.3	16	5
FR1114C-0005	AlGaInP	Red		626	5	6.3	16	5

※Note : The above luminous intensity(I<sub>v</sub>) is the setup values of the sorting machine.  
(Tolerance : I<sub>v</sub>... ± 10%)

## Absolute Maximum Ratings

(Ta=25°C)

Item	Symbol	Absolute Maximum Ratings				Unit
		YPY	FY	FA	FR	
Power Dissipation	$P_d$	36	36	36	36	mW
Forward Current	$I_F$	15	15	15	15	mA
Pulse Forward Current ※1	$I_{FRM}$	48	48	48	48	mA
Derating (Ta=25°C or higher)	$\Delta I_F$	0.21	0.21	0.21	0.21	mA/°C
	$\Delta I_{FRM}$	0.69	0.69	0.69	0.69	mA/°C
Reverse Voltage	$V_R$	5	5	5	5	V
Operating Temperature	$T_{opr}$	-40~+85				°C
Storage Temperature	$T_{stg}$	-40~+100				°C

 ※1  $I_{FRM}$  Measurement condition : Pulse Width  $\leq 1$ ms., Duty  $\leq 1/20$ .

## Electro-Optical Characteristics

(Ta=25°C)

Item	Conditions	Symbol	Characteristics				Unit	
			YPY	FY	FA	FR		
Forward Voltage	I <sub>F</sub> =5mA	V <sub>F</sub>	TYP.	1.9	1.9	1.9	1.9	V
			MAX.	2.4	2.4	2.4	2.4	
Reverse Current	V <sub>R</sub> =5V	I <sub>R</sub>	MAX.	100	100	100	100	μ A
Peak Wavelength	I <sub>F</sub> =5mA	λ <sub>p</sub>	TYP.	575	592	609	635	nm
Dominant Wavelength	I <sub>F</sub> =5mA	λ <sub>d</sub>	TYP.	572	590	605	626	nm
Spectral Line Half Width	I <sub>F</sub> =5mA	Δλ	TYP.	15	15	15	15	nm
Half Intensity Angle	I <sub>F</sub> =5mA	2θ 1/2	TYP.	130(θ x)	130(θ x)	130(θ x)	130(θ x)	deg.
				150(θ y)	150(θ y)	150(θ y)	150(θ y)	

# Luminous Intensity Rank

(Ta=25°C)

Intensity Tolerance each Rank : +/- 10%

Rank	I <sub>v</sub> (mcd)								Condition
	YPY		FY		FA		FR		
	MIN.	MAX.	MIN.	MAX.	MIN.	MAX.	MIN.	MAX.	
A	4.0	6.3	6.3	10.0	6.3	10.0	6.3	10.0	I <sub>F</sub> = 5mA
B	6.3	10.0	10.0	16.0	10.0	16.0	10.0	16.0	
C	10.0	16.0	16.0	25.0	16.0	25.0	16.0	25.0	
D	16.0	25.0	25.0	40.0	25.0	40.0	25.0	40.0	
E	25.0	-	40.0	-	40.0	-	40.0	-	

※ Please contact our sales staff concerning rank designation.

※ Please contact our sales staff concerning rank designation.

Color Tone Groups (  $\lambda d$  )

(Ta=25°C)

Rank	Dominant Wavelength $\lambda d$ (nm)								Condition
	YPY		FY		FA		FR		
	MIN.	MAX.	MIN.	MAX.	MIN.	MAX.	MIN.	MAX.	
A	566.0	578.0	581.5	585.0	596.1	600.9	621.0	632.0	I <sub>F</sub> = 5mA
B			584.0	587.5	599.1	603.9			
C			586.5	590.0	602.1	606.9			
D			589.0	592.5	605.1	609.9			
E			591.5	595.0	608.1	612.9			
F			594.0	597.5					

※ Please contact our sales staff concerning rank designation.

## Technical Data(YPY/FY/FA/FR)

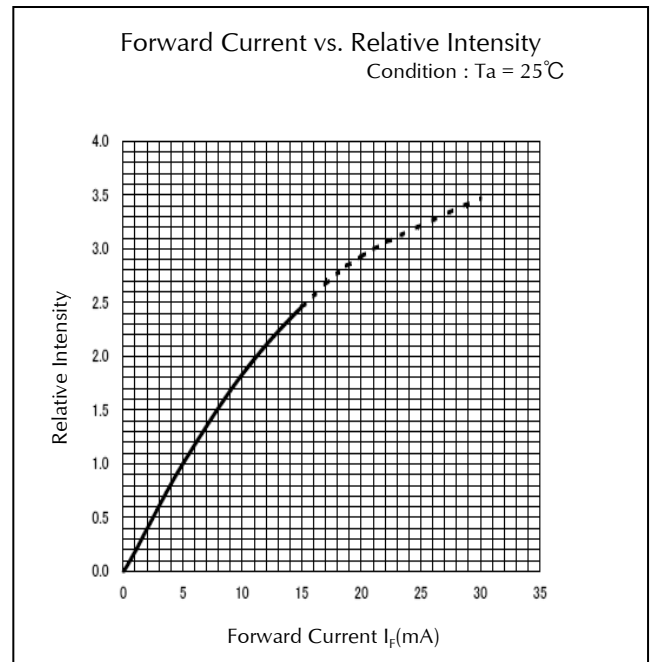
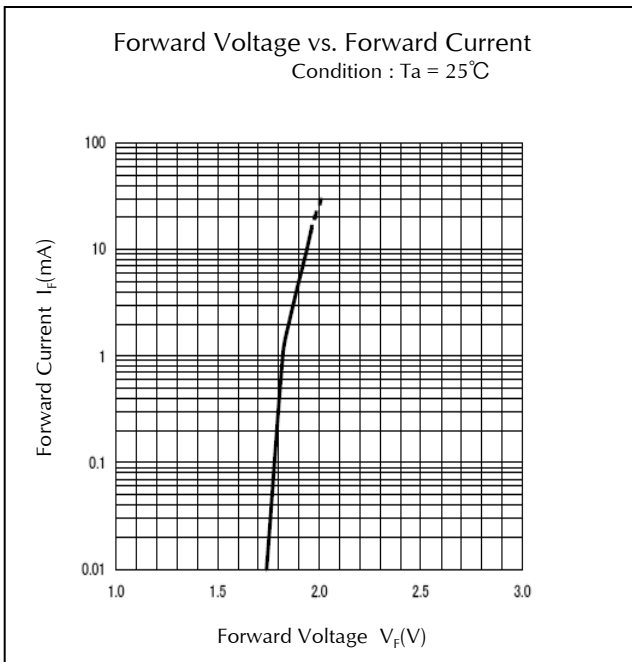
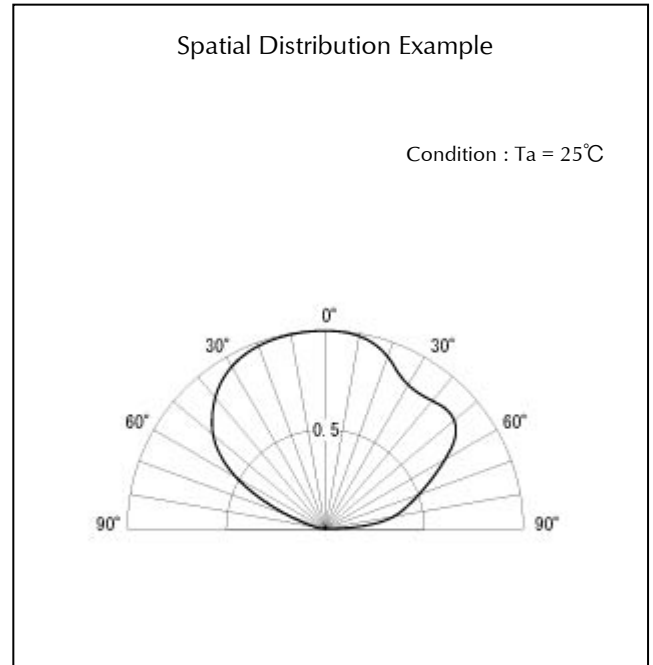
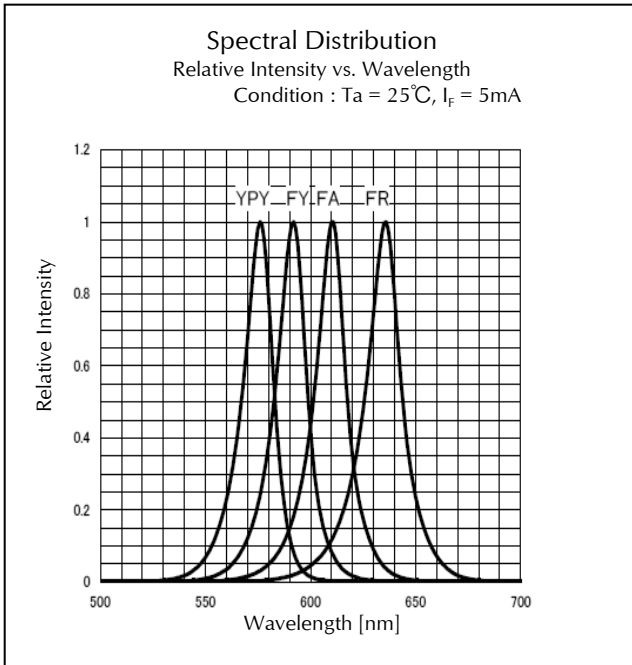

## Technical Data(YPY/FY/FA/FR)

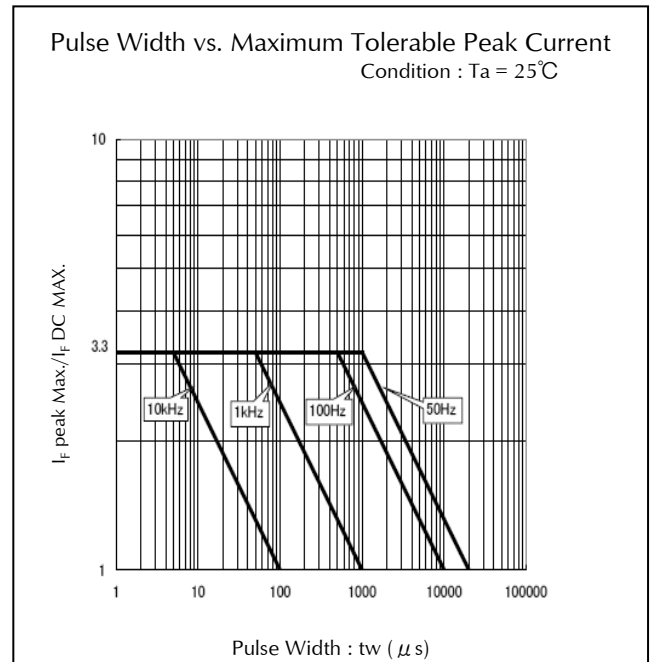
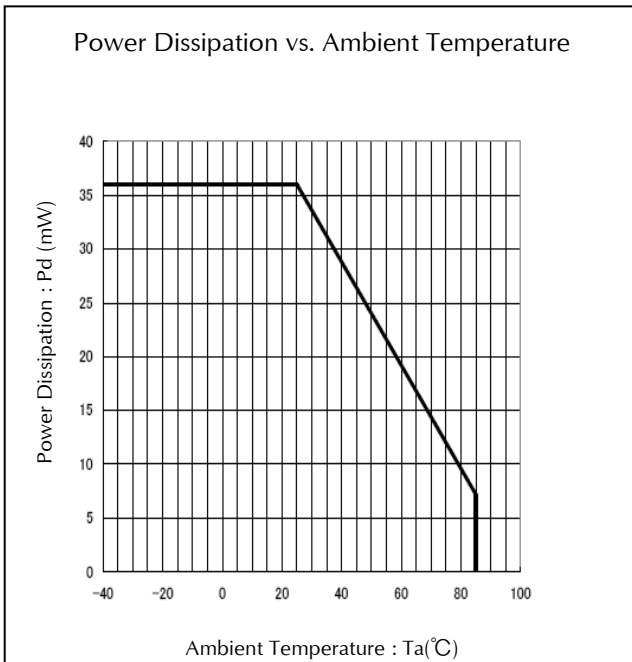
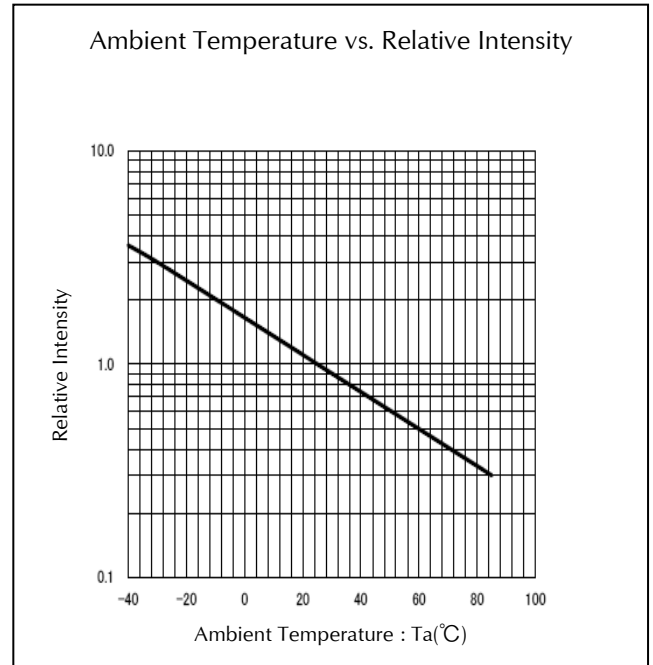
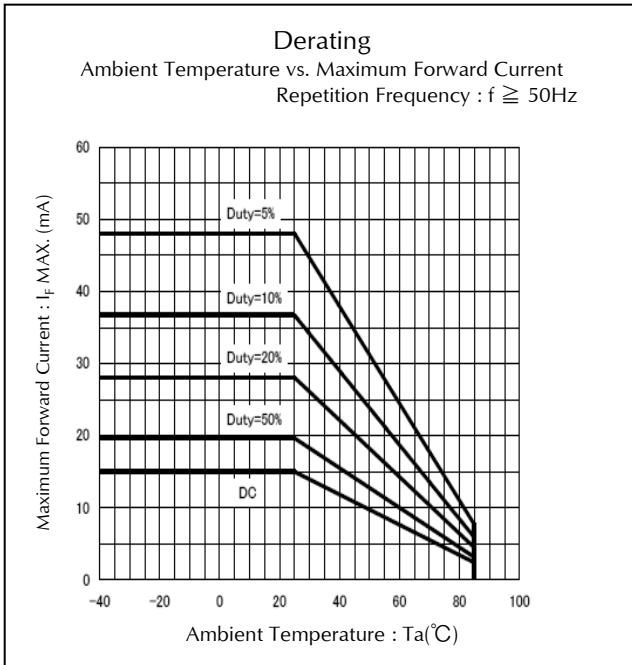



## Technical Data(YPY/FY/FA/FR)

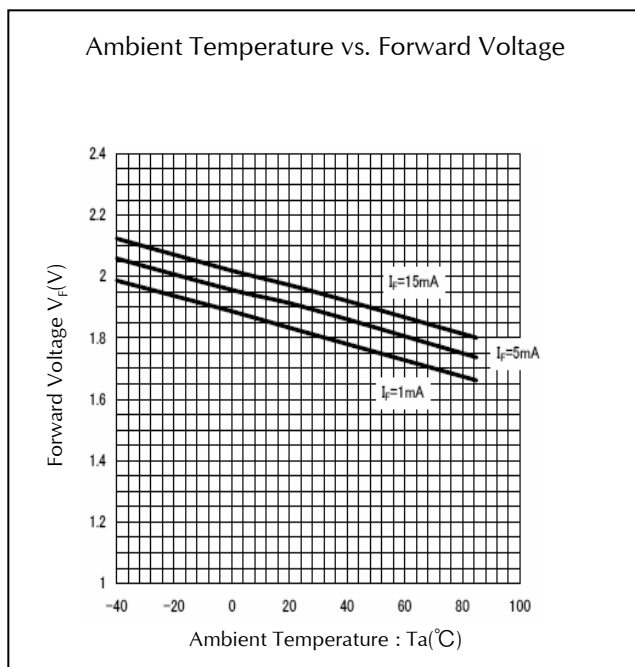
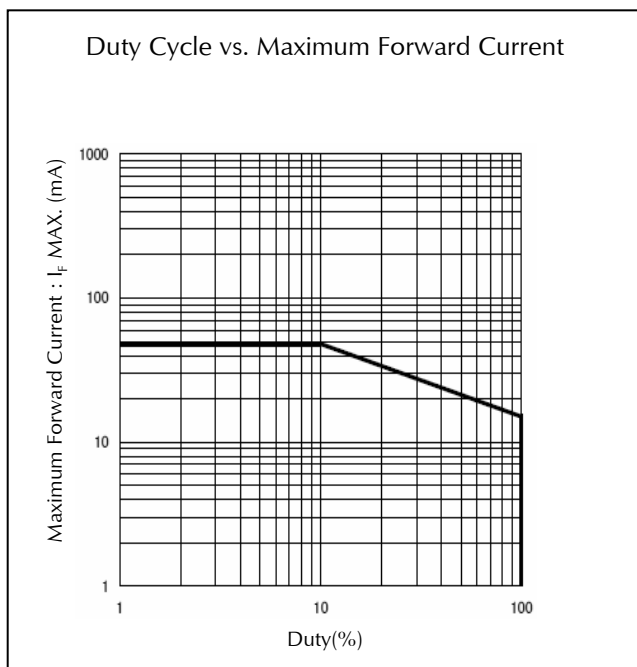

## Package Dimensions

(Unit: mm)

Weight: (1.32)mg

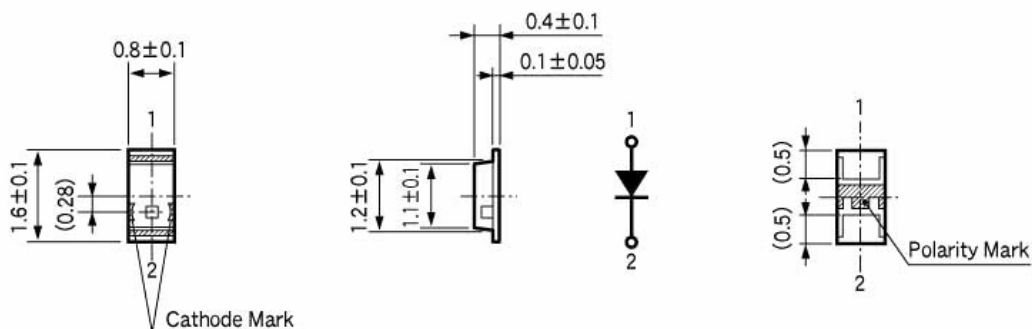

## Recommended Soldering Pattern

(Unit: mm)

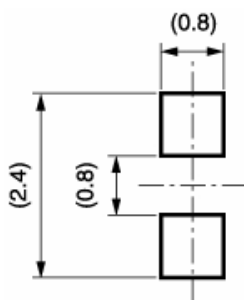

## Taping Specification

(Unit: mm)

Quantity : 4,000pcs/ reel (standard)

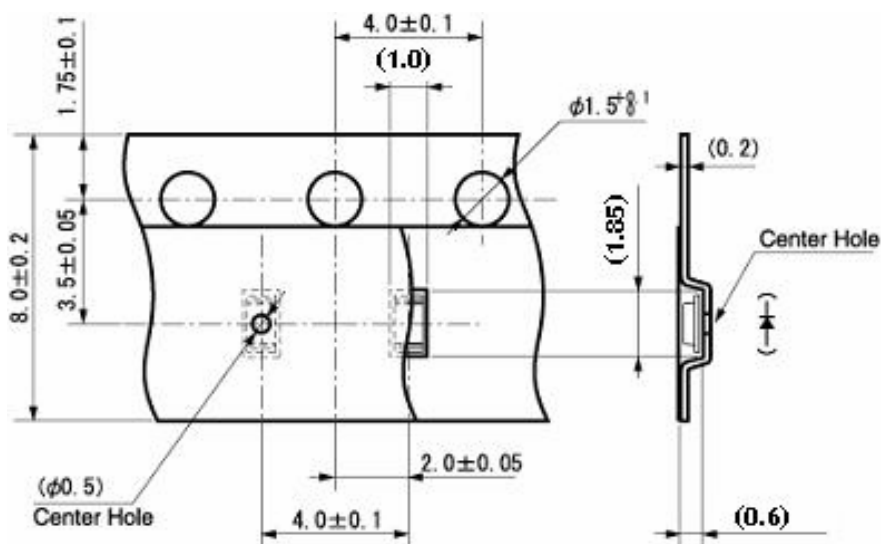

## Reflow Soldering Conditions

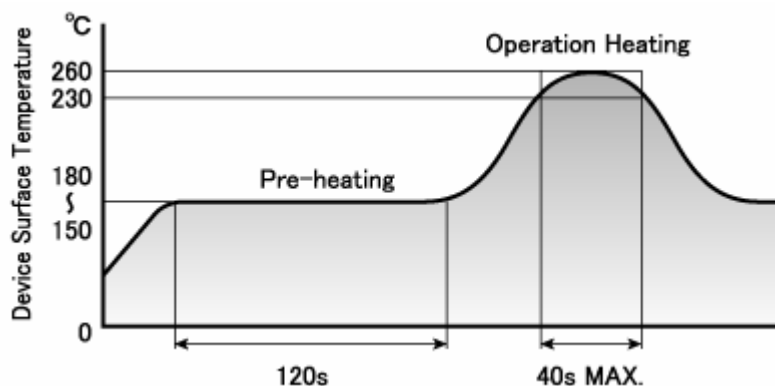

- 1) The above profile temperature gives the maximum temperature of the LED resin surface. Please set the temperature so as to avoid exceeding this range.
- 2) Total times of reflow soldering process shall be no more than 2 times. When the second reflow soldering process is performed, intervals between the first and second reflow should be short as possible (while allowing some time for the component to return to normal temperature after the first reflow) in order to prevent the LED from absorbing moisture.
- 3) Temperature fluctuation to the LED during the pre-heating process shall be minimized.

## Manual Soldering Conditions

Iron tip temp.	350°C	(MAX.)
----------------	-------	--------

Soldering time and frequency	3 s	(MAX.)
	1 time	(MAX.)

## Handling

---

These types are designed chiefly for Cellular phone application, and are setting the thickness of the Product to about 0.4-0.5 mm thinly. To achieve the tin type of the product, making each material thin is aimed at. Because they are inferior to our general LEDs by an external stress, please use these product types after paying attention to the following.

- 1) Please set the mounting load to Max. 2N.
- 2) Please do not increase more quantity of the soldering paste than necessary quantity  
(The thickness of stencil Mask : about 100-120 $\mu$ ), because the terminal area of the product is small.
- 3) Please avoid the collision of the mounting board etc. after LEDs were mounted on the substrate.
- 4) When warp of substrate is large after these were mounted on FPC etc, please use these product types after affirming these is no problem.
- 5) Please use these product types after affirming there is no problem about the mounting position etc. of product from substrate edge, when mounting them on multi-layer and multi-piece PCBs.

## Reliability Testing Result

Reliability Testing Result	Applicable Standard	Testing Conditions	Duration	Failure
Room Temp. Operating Life	EIAJ ED- 4701/100(101)	Ta = 25°C, If = Maximum Rated Current	1,000 h	0/25
Resistance to Soldering Heat	EIAJ ED- 4701/300(301)	Pre-heating : 150~180°C 120s Max. Operation Heating : 230°C 40s Max. Peak Temperature : 260°C	Twice	0/25
Temperature Cycling	EIAJ ED- 4701/100(105)	Minimum Rated Storage Temperature(30min) ~Normal Temperature(15min) ~Maximum Rated Storage Temperature(30min) ~Normal Temperature(15min)	5 cycles	0/25
Wet High Temp. Storage Life	EIAJ ED- 4701/100(103)	Ta = 60±2°C, RH = 90±5%	1,000 h	0/25
High Temp. Storage Life	EIAJ ED- 4701/200(201)	Ta = Maximum Rated Storage Temperature	1,000 h	0/25
Low Temp. Storage Life	EIAJ ED- 4701/200(202)	Ta = Minimum Rated Storage Temperature	1,000 h	0/25
Vibration, Variable Frequency	EIAJ ED- 4701/400(403)	98.1m/s <sup>2</sup> (10G), 100 ~ 2KHz sweep for 20min., XYZ each direction	2 h	0/10

## Failure Criteria

Items	Symbols	Conditions	Failure criteria
Luminous Intensity	Iv	If Value of each product Luminous Intensity	Testing Min. Value < Spec. Min. Value x 0.5
Forward Voltage	V <sub>F</sub>	If Value of each product Forward Voltage	Testing Max. Value ≥ Spec. Max. Value x 1.2
Reverse Current	I <sub>R</sub>	V <sub>R</sub> = Maximum Rated Reverse Voltage V	Testing Max. Value ≥ Spec. Max. Value x 2.5
Cosmetic Appearance	-	-	Occurrence of notable decoloration, deformation and cracking

## Special Notice to Customers Using the Products and Technical Information Shown in This Data Sheet

- 1) The technical information shown in the data sheets are limited to the typical characteristics and circuit examples of the referenced products. It does not constitute the warranting of industrial property nor the granting of any license.
- 2) For the purpose of product improvement, the specifications, characteristics and technical data described in the data sheets are subject to change without prior notice. Therefore it is recommended that the most updated specifications be used in your design.
- 3) When using the products described in the data sheets, please adhere to the maximum ratings for operating voltage, heat dissipation characteristics, and other precautions for use. We are not responsible for any damage which may occur if these specifications are exceeded.
- 4) The products that have been described to this catalog are manufactured so that they will be used for the electrical instrument of the benchmark (OA equipment, telecommunications equipment, AV machine, home appliance and measuring instrument).  
The application of aircrafts, space borne application, transportation equipment, medical equipment and nuclear power control equipment, etc. needs a high reliability and safety, and the breakdown and the wrong operation might influence the life or the human body. Please consult us beforehand if you plan to use our product for the usages of aircrafts, space borne application, transportation equipment, medical equipment and nuclear power control equipment, etc. except OA equipment, telecommunications equipment, AV machine, home appliance and measuring instrument.
- 5) In order to export the products or technologies described in this data sheet which are under the "Foreign Exchange and Foreign Trade Control Law," it is necessary to first obtain an export permit from the Japanese government.
- 6) No part of this data sheet may be reprinted or reproduced without prior written permission from Stanley Electric Co., Ltd.
- 7) The most updated edition of this data sheet can be obtained from the address below:  
<http://www.stanley-components.com>