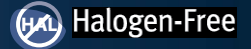

EPC2007C – Enhancement Mode Power Transistor

 $V_{DS}, 100\text{ V}$ $R_{DS(on)}, 30\text{ m}\Omega$ $I_D, 6\text{ A}$ 

Gallium Nitride's exceptionally high electron mobility and low temperature coefficient allows very low $R_{DS(on)}$, while its lateral device structure and majority carrier diode provide exceptionally low Q_G and zero Q_{RR} . The end result is a device that can handle tasks where very high switching frequency, and low on-time are beneficial as well as those where on-state losses dominate.

Maximum Ratings

PARAMETER		VALUE	UNIT
V_{DS}	Drain-to-Source Voltage (Continuous)	100	V
I_D	Continuous ($T_A = 25^\circ\text{C}$, $R_{\theta JA} = 62^\circ\text{C/W}$)	6	A
	Pulsed (25°C , $T_{PULSE} = 300\ \mu\text{s}$)	40	
V_{GS}	Gate-to-Source Voltage	6	V
	Gate-to-Source Voltage	-4	
T_J	Operating Temperature	-40 to 150	$^\circ\text{C}$
T_{STG}	Storage Temperature	-40 to 150	

Thermal Characteristics

PARAMETER		TYP	UNIT
$R_{\theta JC}$	Thermal Resistance, Junction-to-Case	3.6	$^\circ\text{C/W}$
$R_{\theta JB}$	Thermal Resistance, Junction-to-Board	9.3	
$R_{\theta JA}$	Thermal Resistance, Junction-to-Ambient (Note 1)	80	

Note 1: $R_{\theta JA}$ is determined with the device mounted on one square inch of copper pad, single layer 2 oz copper on FR4 board. See https://epc-co.com/epc/documents/product-training/Appnote_Thermal_Performance_of_eGaN_FETs.pdf for details.

Static Characteristics ($T_J = 25^\circ\text{C}$ unless otherwise stated)

PARAMETER		TEST CONDITIONS	MIN	TYP	MAX	UNIT
BV_{DSS}	Drain-to-Source Voltage	$V_{GS} = 0\text{ V}$, $I_D = 75\ \mu\text{A}$	100			V
I_{DSS}	Drain-Source Leakage	$V_{GS} = 0\text{ V}$, $V_{DS} = 80\text{ V}$		20	60	μA
I_{GSS}	Gate-to-Source Forward Leakage	$V_{GS} = 5\text{ V}$		0.25	2	mA
	Gate-to-Source Reverse Leakage	$V_{GS} = -4\text{ V}$		20	60	μA
$V_{GS(TH)}$	Gate Threshold Voltage	$V_{DS} = V_{GS}$, $I_D = 1.2\text{ mA}$	0.8	1.4	2.5	V
$R_{DS(on)}$	Drain-Source On Resistance	$V_{GS} = 5\text{ V}$, $I_D = 6\text{ A}$		24	30	m Ω
V_{SD}	Source-Drain Forward Voltage	$I_S = 0.5\text{ A}$, $V_{GS} = 0\text{ V}$		2.1		V

All measurements were done with substrate connected to source.



EPC2007C eGaN® FETs are supplied only in passivated die form with solder bumps

Applications

- High Speed DC-DC conversion
- Class-D Audio
- Wireless Power Transfer
- Lidar

Benefits

- Ultra High Efficiency
- Zero Q_{RR}
- Ultra Low Q_G
- Ultra Small Footprint

Dynamic Characteristics ($T_j = 25^\circ\text{C}$ unless otherwise stated)

PARAMETER		TEST CONDITIONS	MIN	TYP	MAX	UNIT
C_{ISS}	Input Capacitance	$V_{DS} = 50\text{ V}, V_{GS} = 0\text{ V}$		170	220	pF
C_{RSS}	Reverse Transfer Capacitance			1.9	2.7	
C_{OSS}	Output Capacitance			110	165	
R_G	Gate Resistance			0.4		Ω
Q_G	Total Gate Charge	$V_{DS} = 50\text{ V}, V_{GS} = 5\text{ V}, I_D = 6\text{ A}$		1.6	2.2	nC
Q_{GS}	Gate-to-Source Charge	$V_{DS} = 50\text{ V}, I_D = 6\text{ A}$		0.6		
Q_{GD}	Gate-to-Drain Charge			0.3	0.6	
$Q_{G(TH)}$	Gate Charge at Threshold			0.4		
Q_{OSS}	Output Charge	$V_{DS} = 50\text{ V}, V_{GS} = 0\text{ V}$		8.3	12.5	
Q_{RR}	Source-Drain Recovery Charge			0		

All measurements were done with substrate connected to source.

Note 2: $C_{OSS(ER)}$ is a fixed capacitance that gives the same stored energy as C_{OSS} while V_{DS} is rising from 0 to 50% BV_{DSS} .

Note 3: $C_{OSS(TR)}$ is a fixed capacitance that gives the same charging time as C_{OSS} while V_{DS} is rising from 0 to 50% BV_{DSS} .

Figure 1: Typical Output Characteristics at 25 °C

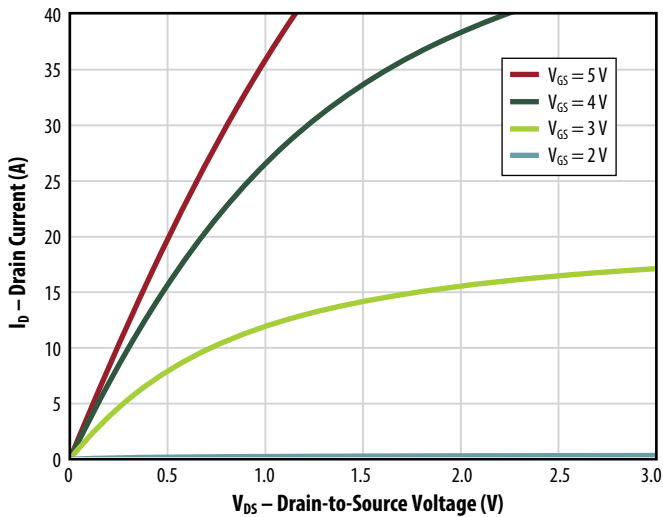

Figure 2: Transfer Characteristics

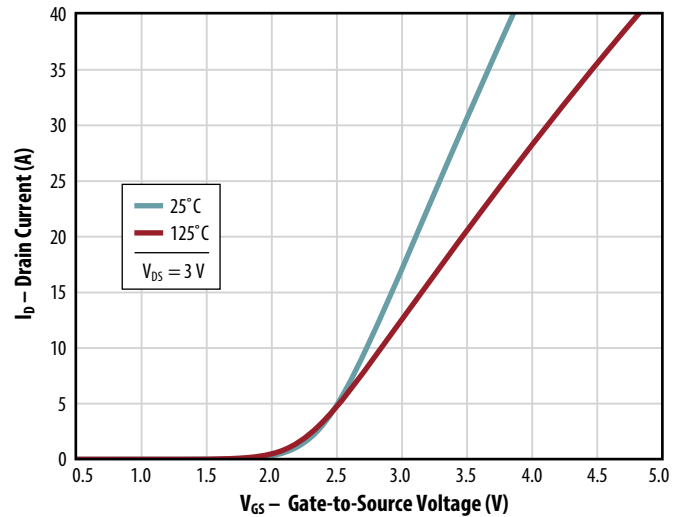

Figure 3: $R_{DS(on)}$ vs. V_{GS} for Various Drain Currents

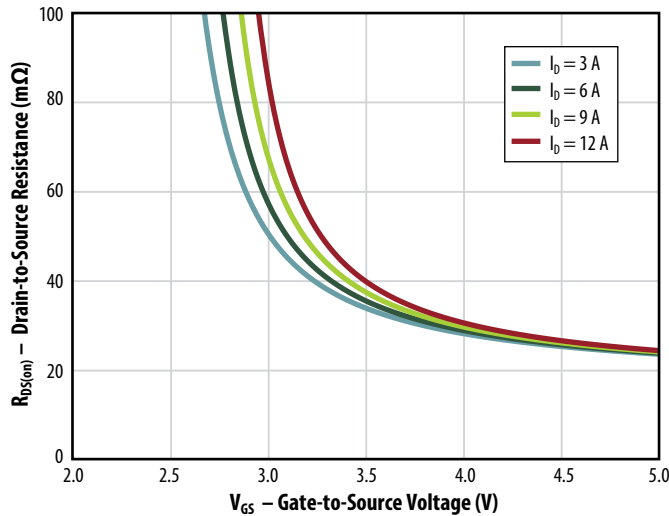

Figure 4: $R_{DS(on)}$ vs. V_{GS} for Various Temperatures

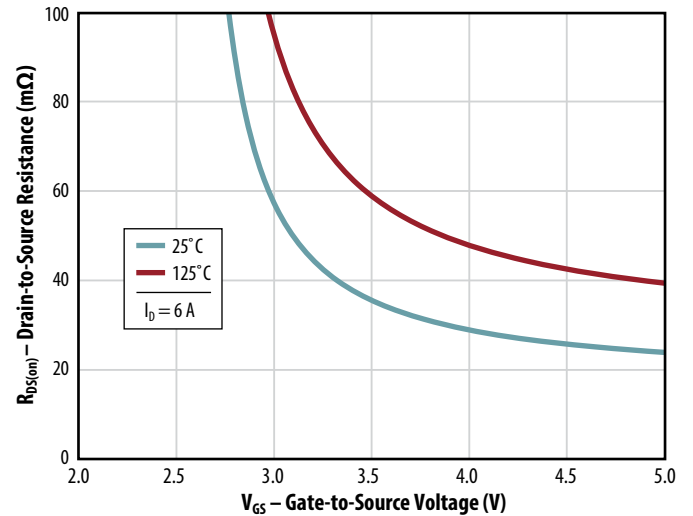

Figure 5a: Capacitance (Linear Scale)

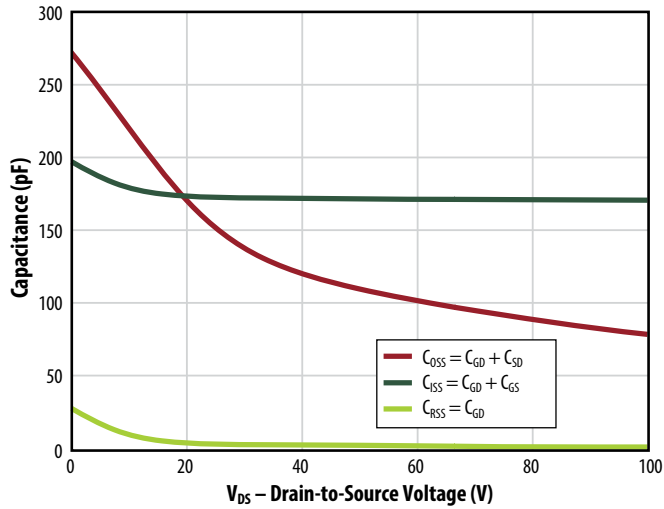

Figure 5b: Capacitance (Log Scale)

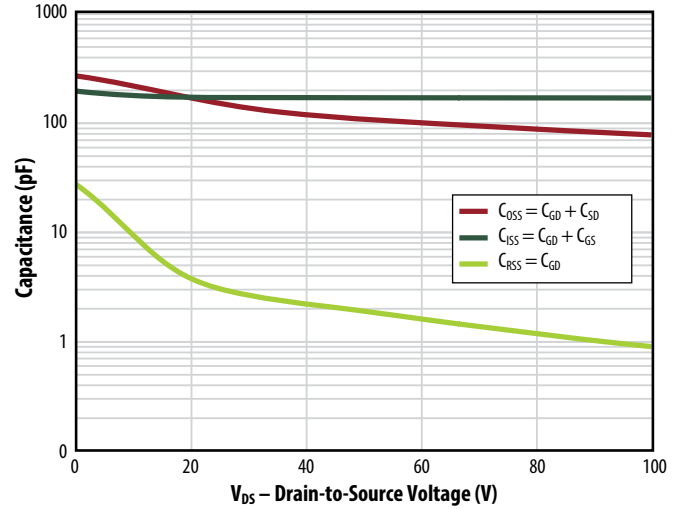

Figure 6: Gate Charge

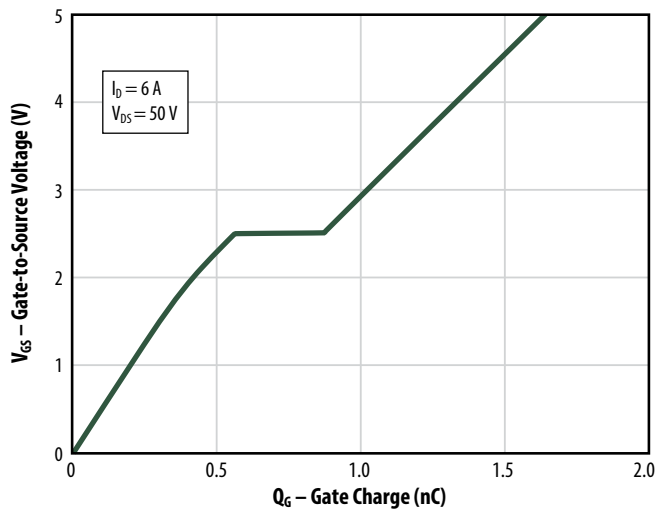

Figure 7: Reverse Drain-Source Characteristics

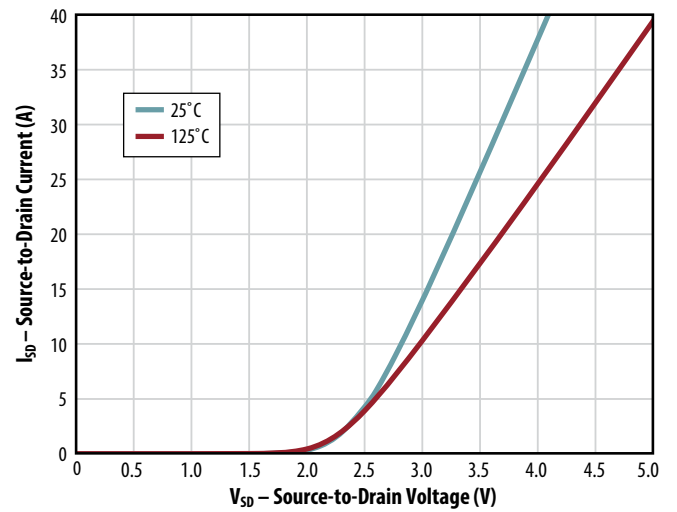

Figure 8: Normalized On-State Resistance vs. Temperature

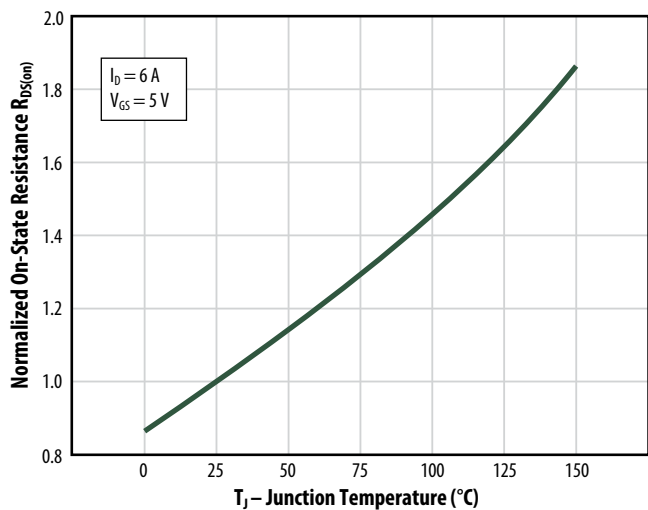
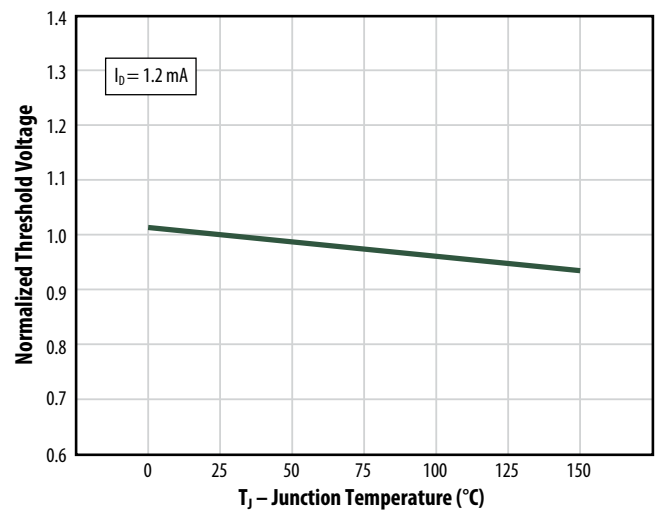

Figure 9: Normalized Threshold Voltage vs. Temperature



All measurements were done with substrate shorted to source.

Figure 10: Gate Leakage Current

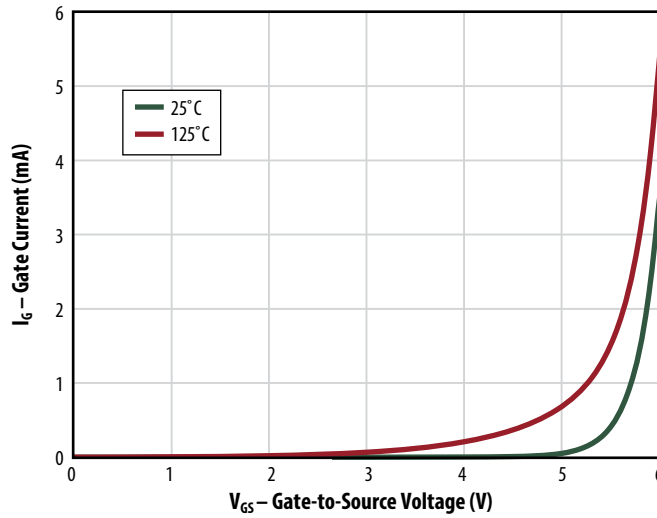

Figure 11: Transient Thermal Response Curves

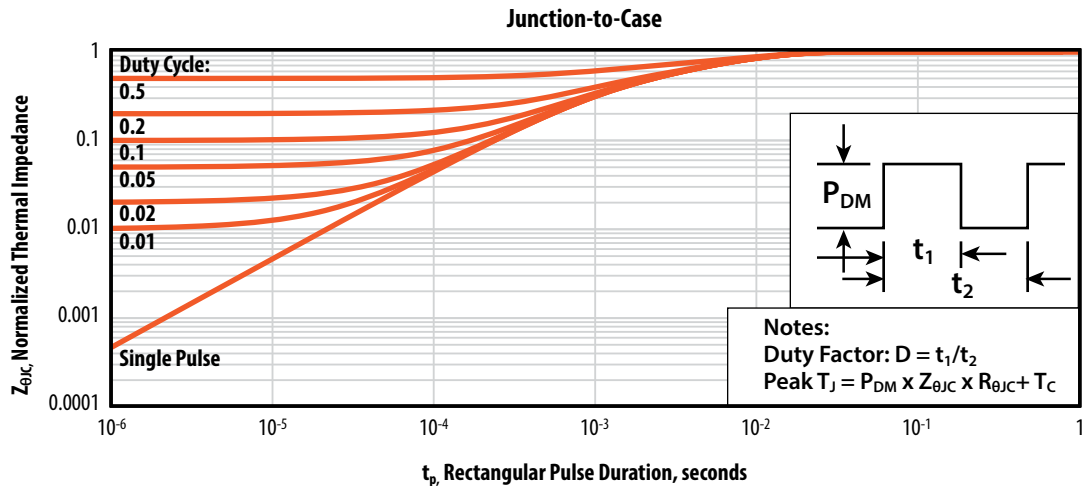
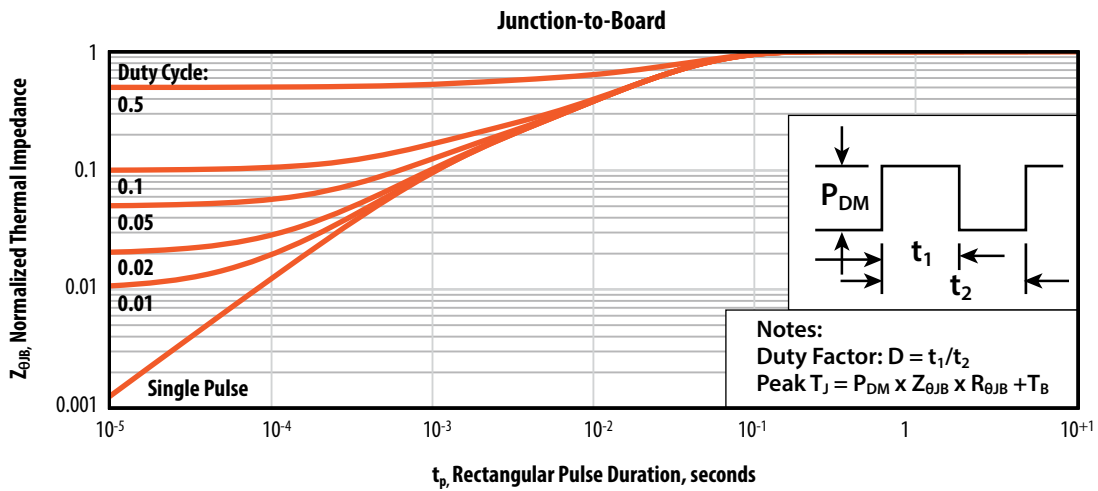
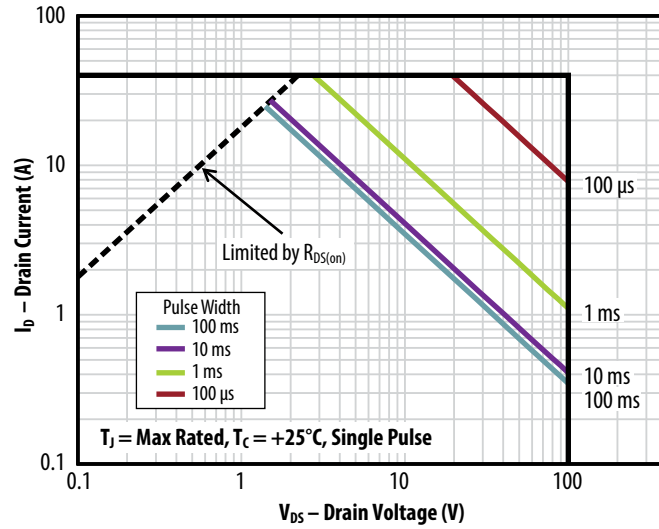
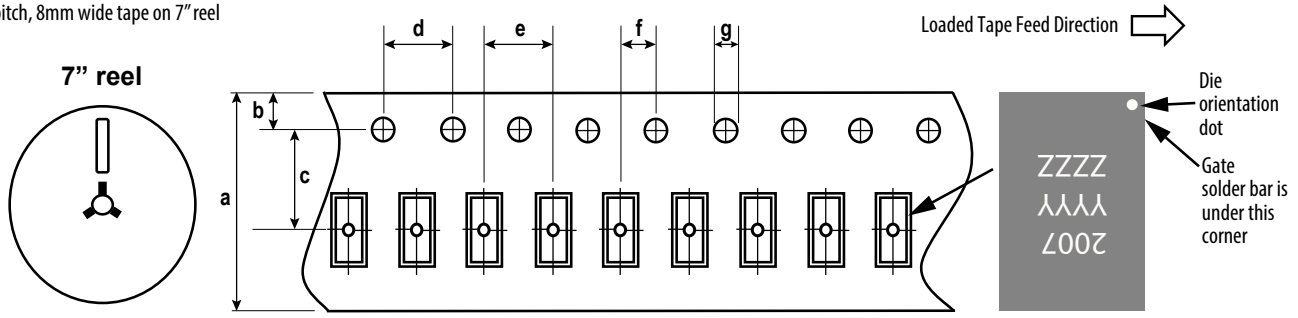

Figure 12: Safe Operating Area



TAPE AND REEL CONFIGURATION

4mm pitch, 8mm wide tape on 7" reel



Dimension (mm)	EPC2007C (note 1)		
	target	min	max
a	8.00	7.90	8.30
b	1.75	1.65	1.85
c (note 2)	3.50	3.45	3.55
d	4.00	3.90	4.10
e	4.00	3.90	4.10
f (note 2)	2.00	1.95	2.05
g	1.5	1.5	1.6

Note 1: MSL 1 (moisture sensitivity level 1) classified according to IPC/JEDEC industry standard.
 Note 2: Pocket position is relative to the sprocket hole measured as true position of the pocket, not the pocket hole.

DIE MARKINGS

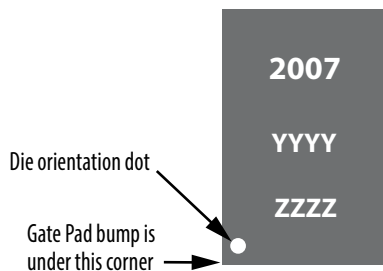

Part Number	Laser Markings		
	Part # Marking Line 1	Lot_Date Code Marking line 2	Lot_Date Code Marking Line 3
EPC2007C	2007	YYYY	ZZZZ

DIE OUTLINE

Solder Bar View

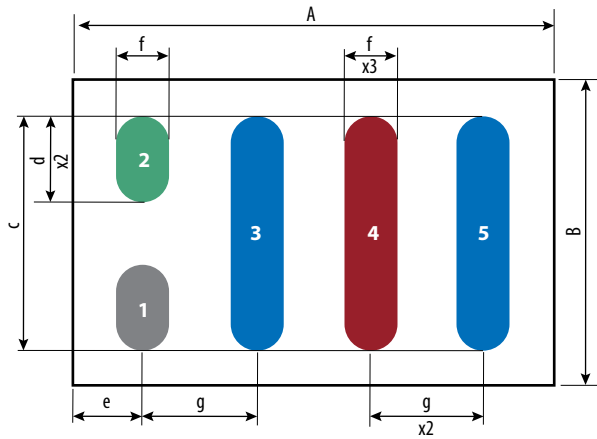

Side View

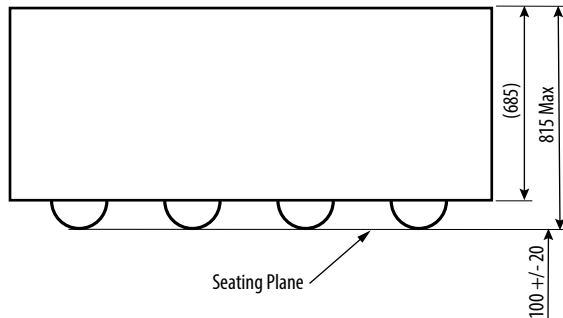

DIM	MICROMETERS		
	MIN	Nominal	MAX
A	1672	1702	1732
B	1057	1087	1117
c	829	834	839
d	311	316	321
e	235	250	265
f	195	200	205
g	400	400	400

Pad no. 1 is Gate;

Pad no. 2 is Substrate,*

Pads no. 3 and 5 are Drain;

Pad no. 4 is Source

*Substrate pin should be connected to Source

RECOMMENDED LAND PATTERN

(measurements in μm)

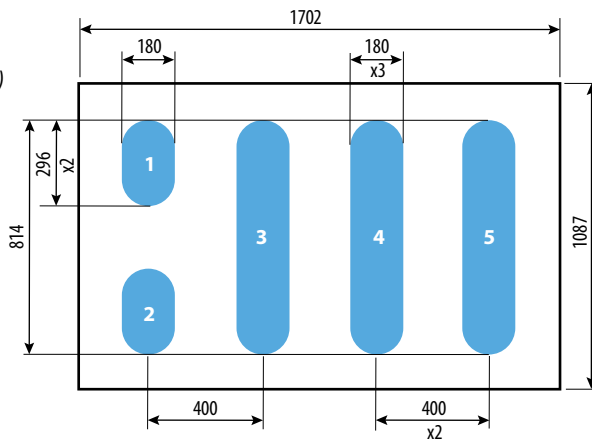

The land pattern is solder mask defined

Solder mask is 10 μm smaller per side than bump

Pad no. 1 is Gate

Pad no. 2 is Substrate*

Pads no. 3 and 5 are Drain

Pad no. 4 is Source

*Substrate pin should be connected to Source

RECOMMENDED STENCIL DRAWING

(units in μm)

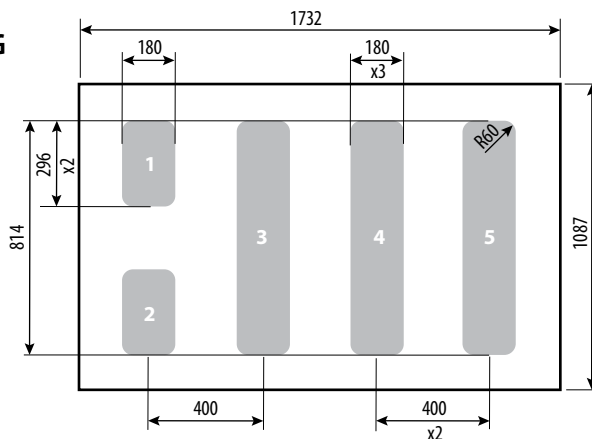

Recommended stencil should be 4 mil (100 μm)

thick, must be laser cut, opening per drawing.

The corner has a radius of R60.

Intended for use with SAC305 Type 3 solder, reference 88.5% metals content.

Additional assembly resources available at

<https://www.epc-co.com/epc/DesignSupport/AssemblyBasics.aspx>

Efficient Power Conversion Corporation (EPC) reserves the right to make changes without further notice to any products herein to improve reliability, function or design. EPC does not assume any liability arising out of the application or use of any product or circuit described herein; neither does it convey any license under its patent rights, nor the rights of others.

eGaN® is a registered trademark of Efficient Power Conversion Corporation.

EPC Patent Listing: epc-co.com/epc/AboutEPC/Patents.aspx

Information subject to change without notice.

Revised August, 2019