

DRV8834 Evaluation Module

This document is provided as a supplement to the [DRV8834](#) datasheet. It details the hardware implementation of the DRV8834 customer evaluation module (EVM).

Contents

1	Introduction	2
2	Block Diagram	2
	2.1 Power Connectors	3
	2.2 Test Stakes	3
	2.3 Jumpers	4
	2.4 Switches	4
	2.5 Motor Outputs	4
3	GUI Software Installation	4
	3.1 System Requirements	4
	3.2 Installation Procedure	4
4	The Windows Application	15
	4.1 Dual H Bridge Mode	16
	4.2 The CONFIG Control Signal	18
	4.3 Configuring Switches	18
	4.4 Menu Options	19
	4.5 DRV8834 GPIO Control Signals	20
	4.6 Updating DAC Output for Current Control (VREF)	20
	4.7 Stepper Control	21
	4.8 Move Steps Frame	22
5	Schematics and Bill of Materials	24
	5.1 Schematics	24
	5.2 Bill of Materials	26

Trademarks

Windows is a registered trademark of Microsoft corporation.
All other trademarks are the property of their respective owners.

1 Introduction

The DRV8834 customer EVM is a platform revolving around the DRV8834, a low voltage dual H-bridge driver and highly configurable power stage. This device has been optimized to drive either two brushed DC motors, a single bipolar stepper with up to 32 degrees of internally generated microstepping, or a single bipolar stepper with high resolution externally generated microstepping. In this EVM, high resolution is meant to imply 512 degrees of microstepping, but higher resolution, as given by any given DAC resource, can be implemented.

The EVM houses an MSP430 microcontroller and an USB interface chip. The USB chip allows for serial communications from a PC computer where a Windows® application is used to schedule serial commands. These commands can be used to control each of the device's signals, or control both devices at the same time to drive a stepper motor.

The microcontroller firmware operates in one of three modes. Each of the three modes can be selected through the Windows application by choosing the respective operation TAB. The three modes are:

- Dual H-Bridge with independent current control and PWM control on the ENABLE and PHASE lines.
- Internal indexer microstepping driver capable of supplying up to 32 degrees of microstepping to a single bipolar stepper motor.
- Dual H-Bridge configured to supply up to 512 degrees of microstepping to a single bipolar stepper motor.

This user's guide details the operation of the EVM in any of the three modes, as well as the hardware configurability of the evaluation module.

2 Block Diagram

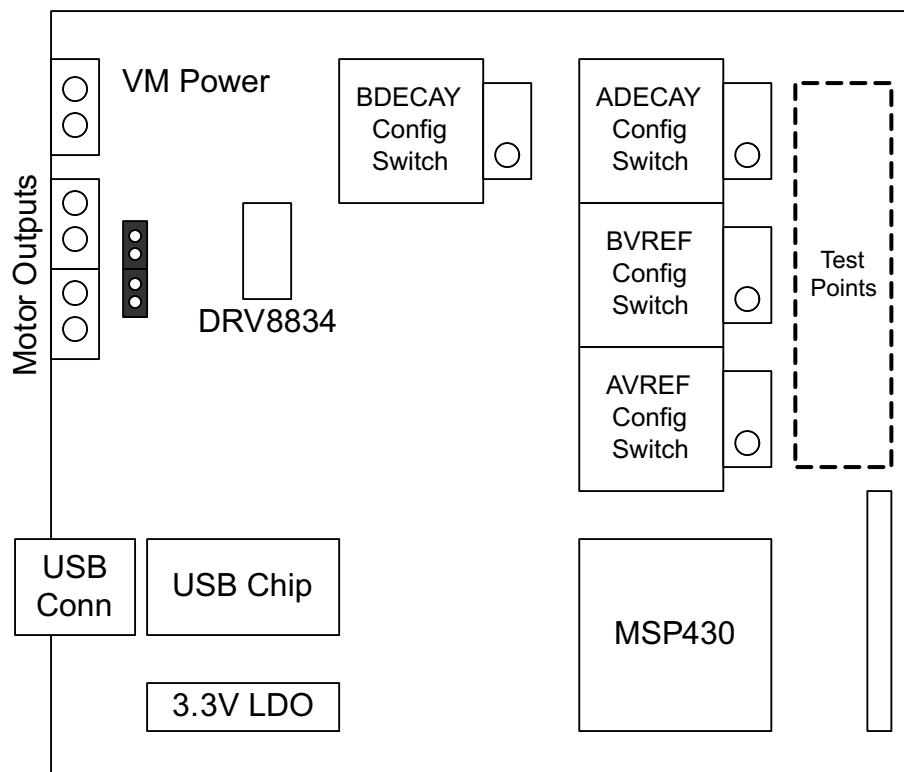

2.1 Power Connectors

The DRV8834EVM offers access to VM (motor voltage) power rail via a terminal block (J1). A set of test clips in parallel with the terminal block allows for the monitoring of the input power rail.

User must apply VM according to datasheet recommended parameters.

NOTE: VDD for logic and microcontroller is derived from a provided 3.3-V regulator stepped down from the VM input voltage.

2.2 Test Stakes

A 0.100 inch pitch header connector (J3) is used to provide access to every device signal in the event a different microcontroller is to be employed. To disconnect the internal MSP430 microcontroller, simply remove power to this resource by removing the shunt from the JP3 jumper.

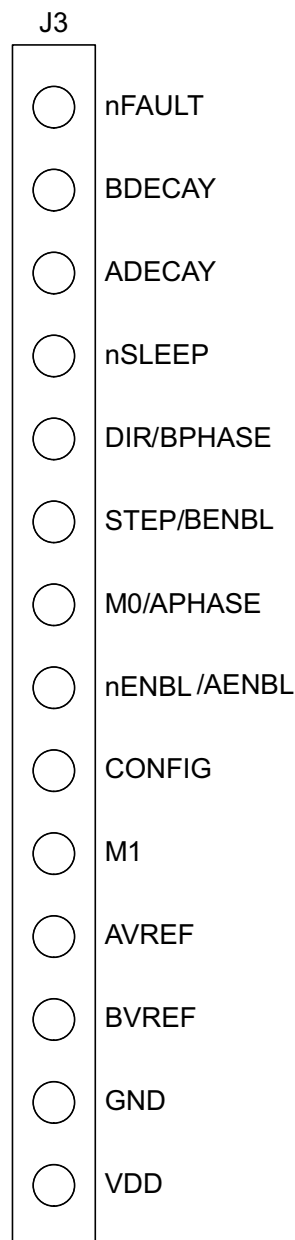

Figure 1. J3 Connector

2.3 Jumpers

The DRV8834EVM module contains three 2-pin jumpers which the user can remove in order modify certain aspects of configuration.

- JP1: Place a shunt to enable the D1 LED signaling of any fault occurrence.
- JP3: Place a shunt to allow 3.3-V supply to the microcontroller. Remove the shunt to disable MSP430 microcontroller and use external microcontroller of choice.
- JP4: Place a shunt to provide VM power to the LDO. Remove to disconnect all VM loading except DRV8834 device.

2.4 Switches

A series of switches allow the proper selection of analog input to configure the reference voltage and decay set points.

Table 1. Switches

SWITCH NAME	DESCRIPTION
BDECAY SEL	Selects Decay B source to be MSP430 GPIO (only HI or LO), externally supplied or derived from the R1 potentiometer.
ADECAY SEL	Selects Decay A source to be MSP430 GPIO (only HI or LO), externally supplied or derived from the R2 potentiometer.
BVREF SEL	Selects Reference Voltage B source to be same as VREFA (used on internal indexer mode), MSP430 DAC, externally supplied or derived from the R7 potentiometer.
AVREF SEL	Selects Reference Voltage A source to be MSP430 DAC, externally supplied or derived from the R6 potentiometer.

Each switch position is properly documented on the board's top layer overlay silk screen.

2.5 Motor Outputs

There are two ways of connecting the dual brushed DC motor or the single bipolar stepper motor into the DRV8834 evaluation module: four pin header (J2) or four position terminal block (J4).

3 GUI Software Installation

The following section explains the location of files and the procedure for installing the software correctly.

NOTE: Ensure that no USB connections are made to the EVM until the installation is completed. The installer will also install LabVIEW RTE 2014 and FTDI Driver, along with the GUI.

3.1 System Requirements

- Supported OS – Windows 7 (32 Bit, 64 Bit). The window text size should be Smaller-100% (Default)
- Recommended RAM - 4 GB or higher
- Recommended CPU Operating Speed – 3.3 GHz or higher

3.2 Installation Procedure

The following procedure helps you install the DRV8834 GUI

1. Double click on the **Setup_DRV8834_EVM.exe** as shown in [Figure 2](#).

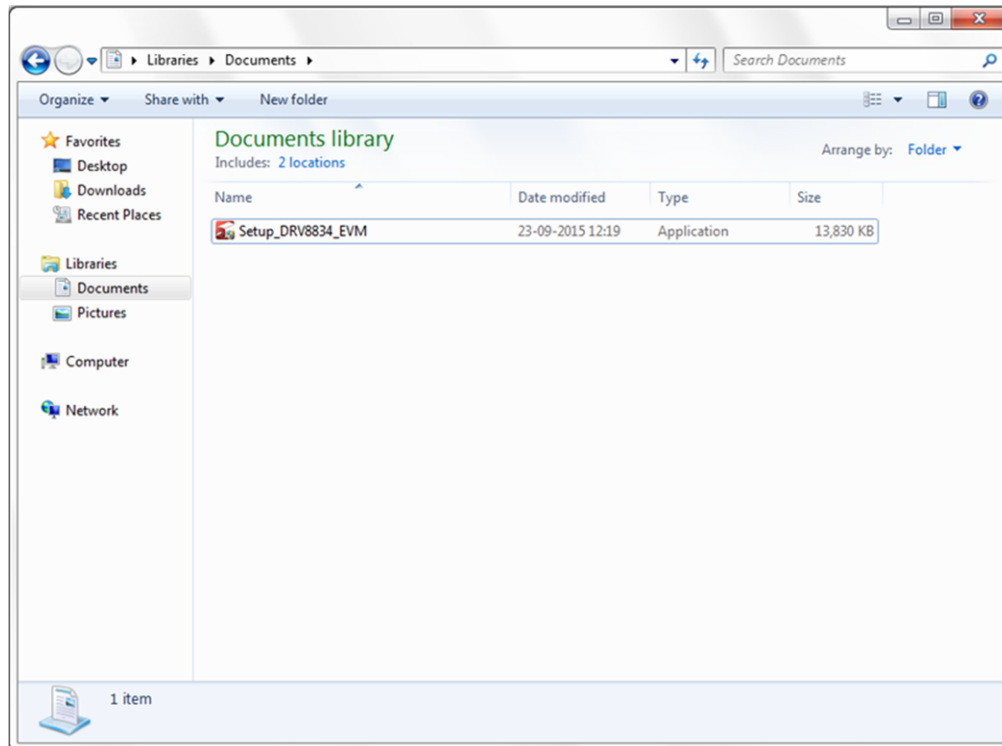

Figure 2. Setup_DRV8834_EVM.exe

2. The screen shown in [Figure 3](#) appears, indicating installer initialization. Click the **Next** button.

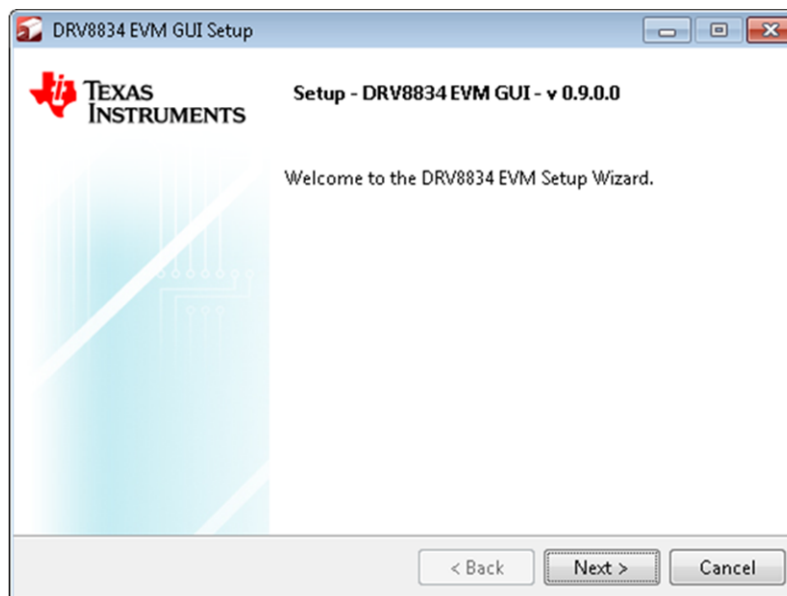

Figure 3. Installation Initialization

3. In the newly open installation pop-up window, click **Next**. The license agreement will be displayed. Please, read through it carefully and enable the "I Accept the Agreement" radio button and press **Next**.



Figure 4. License Agreement

4. A screen as shown in [Figure 5](#) appears, displaying the license agreement of National Instruments. Please read through the agreement carefully and enable the “I Accept the License Agreement” radio button and press the **Next** button.



Figure 5. NI License Agreement

5. Set the default directory for the GUI Installation and click **Next**.

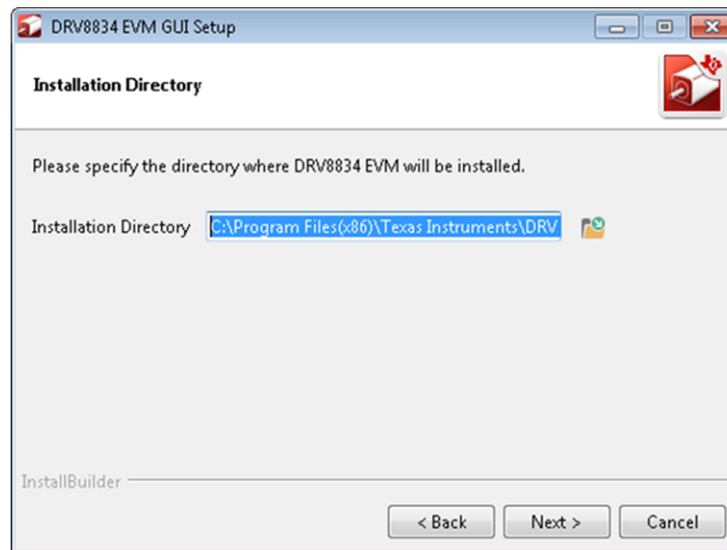

Figure 6. Installation Directory Screen

NOTE: It is highly recommended to keep the default values as provided in the installer.

6. A screen as shown in [Figure 7](#) appears. This screen is to select the components to install. Select the Components to Install and Click **Next** to continue installation. The LabVIEW RTE component checks out if the LabVIEW RTE 2014 is already installed on the PC.

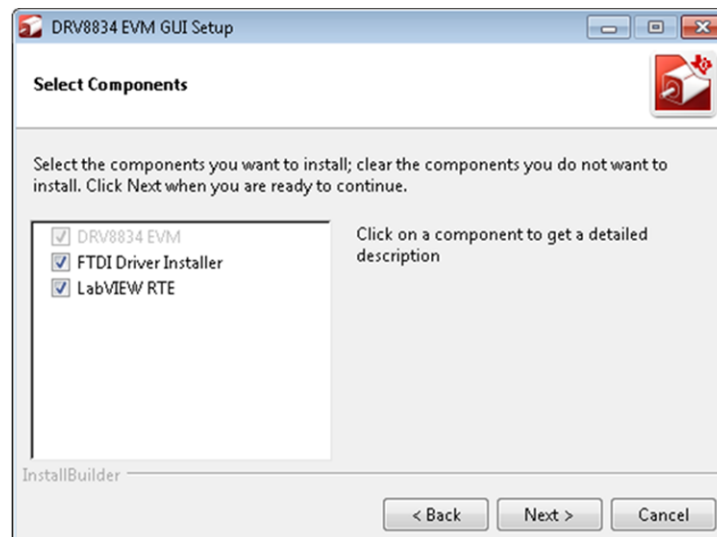

Figure 7. Component Selection

7. If LabVIEW RTE is selected as a component to install, a screen appears as shown in [Figure 8](#). Configure the proxy settings as required. This screen is to download the LabVIEW RTE 2014 from ni.com, Click **Next** to continue the installation.

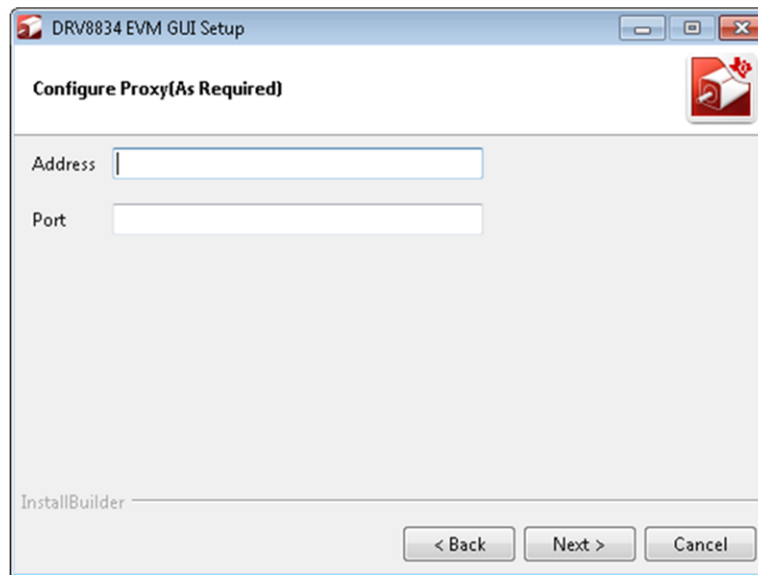

Figure 8. Configure Proxy

8. A screen as shown in [Figure 9](#) appears. Click **Next** to begin the installation.

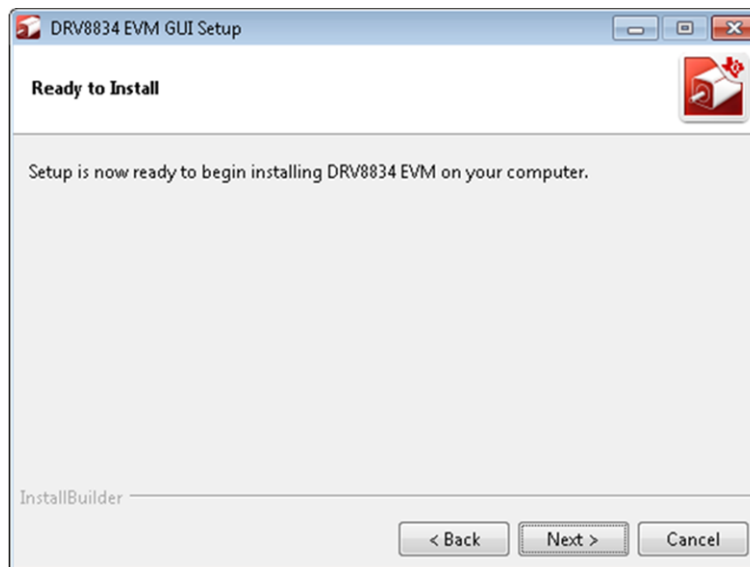

Figure 9. Ready to Install

9. If the LabVIEW RTE 2014 is selected as a component to install, LabVIEW RTE downloads and performs a silent mode installation.

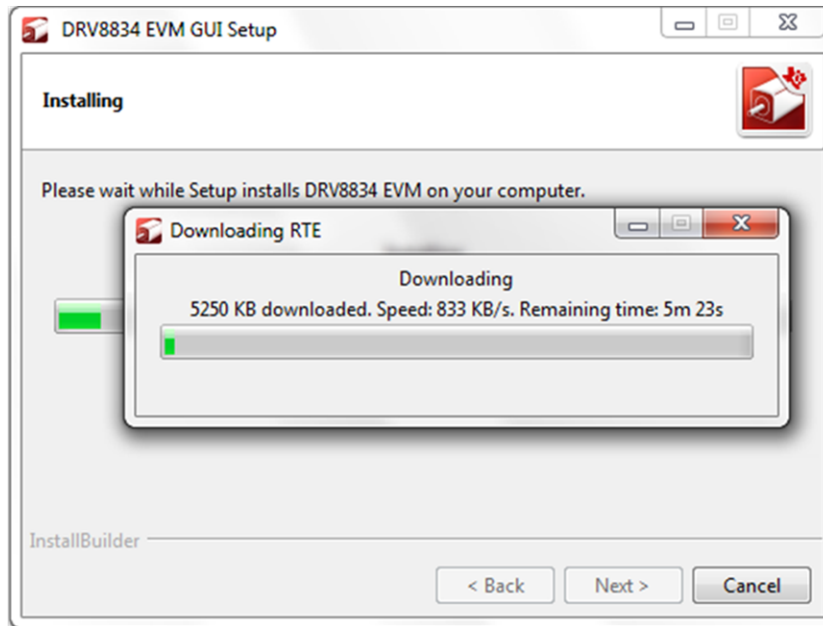

Figure 10. Downloading RTE

10. Once the download completes, LabVIEW begins with the self-extraction as shown in [Figure 11](#).

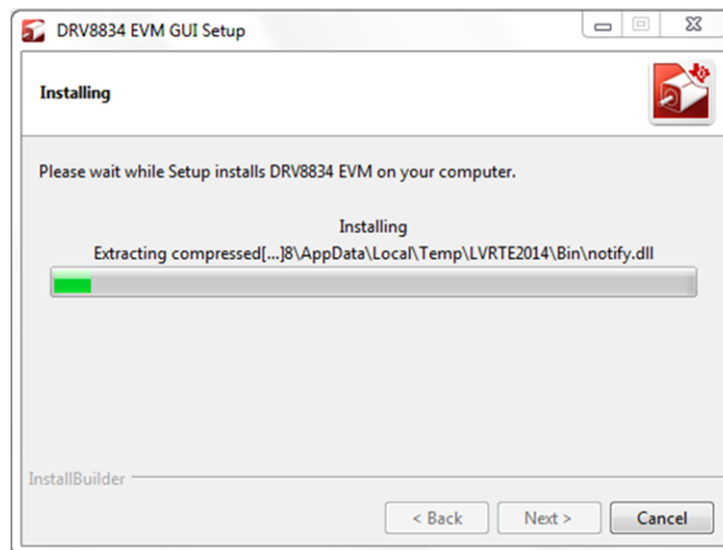

Figure 11. LabVIEW RTE Self Extraction

11. A screen appears as shown in [Figure 12](#). It initializes the LabVIEW RTE Installation.

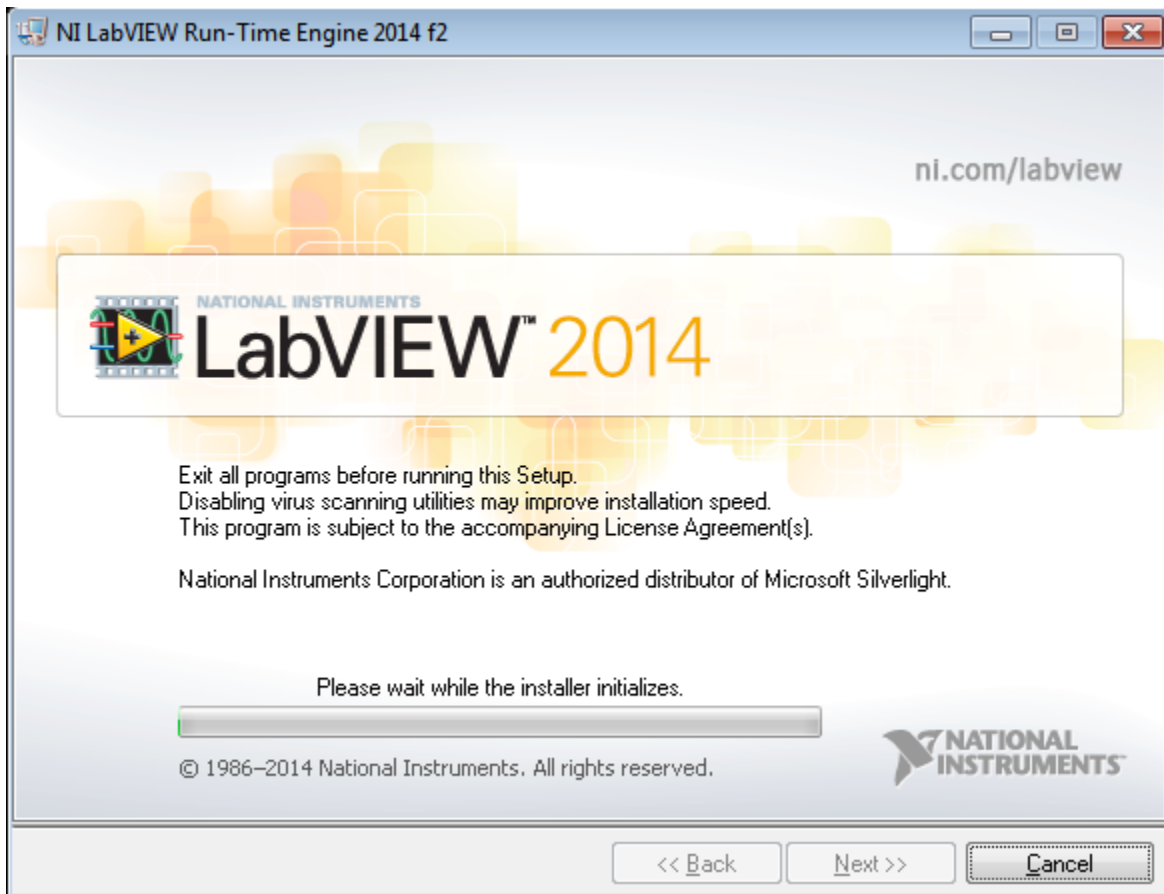

Figure 12. LabVIEW RTE Installation Initialization

12. A display as shown in [Figure 13](#) appears which indicates the progress of LabVIEW RTE installation.

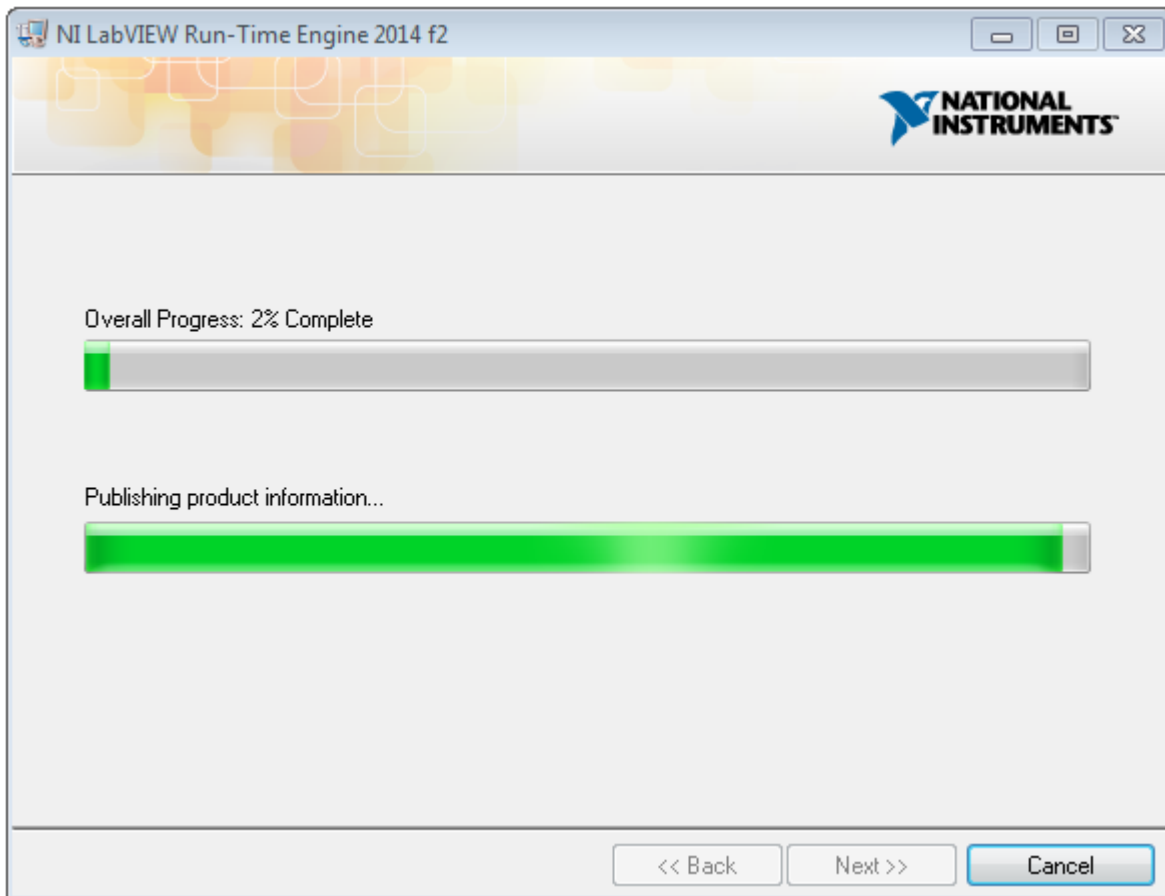

Figure 13. Installation of LabVIEW RTE in Progress

13. Once the LabVIEW RTE 2014 is installed, DRV 8834 EVM GUI component installs.
14. After DRV8834 Installation, FTDI Installation begins. A screen as shown in [Figure 14](#) appears, click **Extract** to proceed.

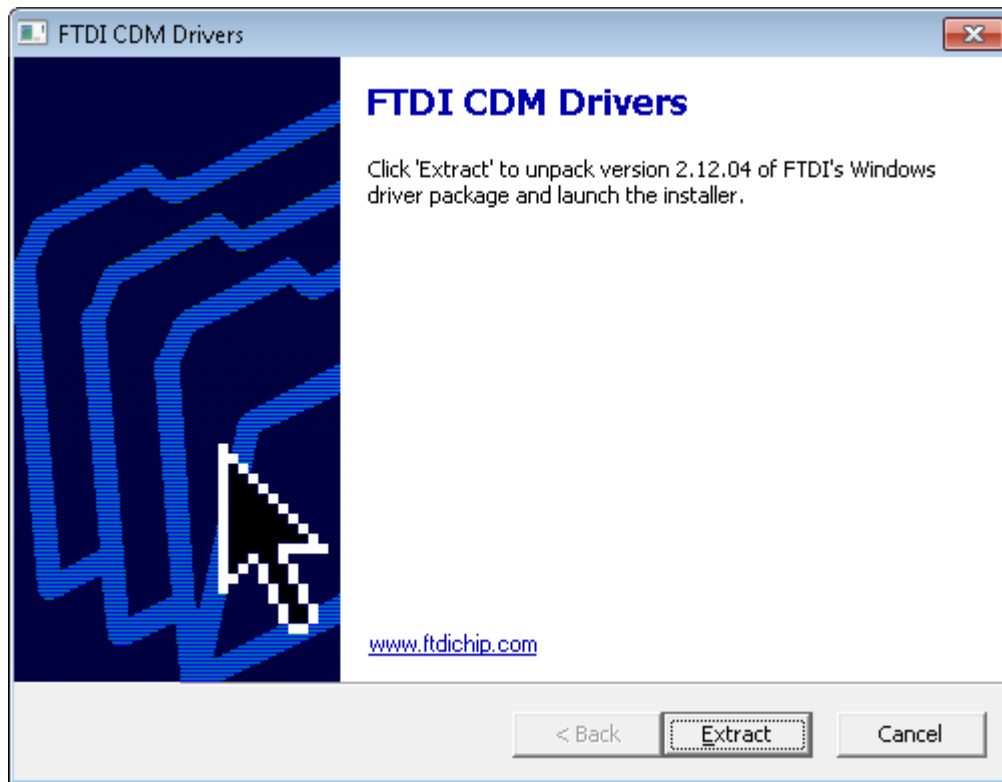

Figure 14. FTDI Installation Initialization

15. A screen as shown in [Figure 15](#) appears, click **Next** to proceed.

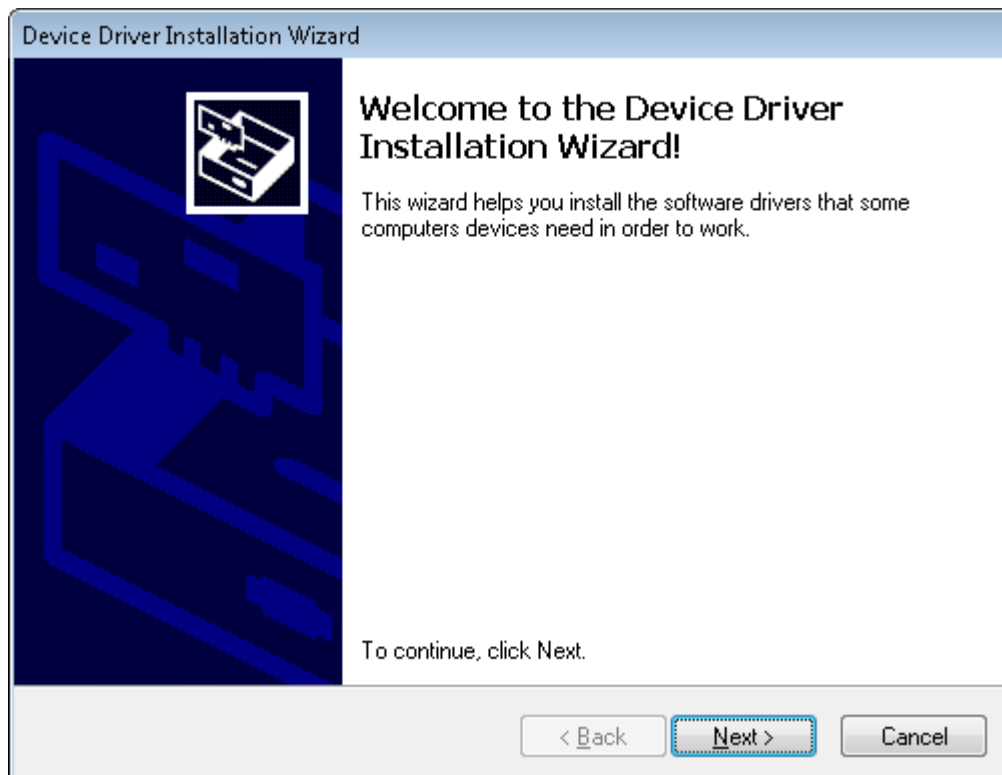

Figure 15. Driver Installation Wizard

16. The License Agreement appears on screen as shown below.
17. Read through the License Agreement carefully and enable the "I Accept this Agreement" radio button and Click on **Next**.

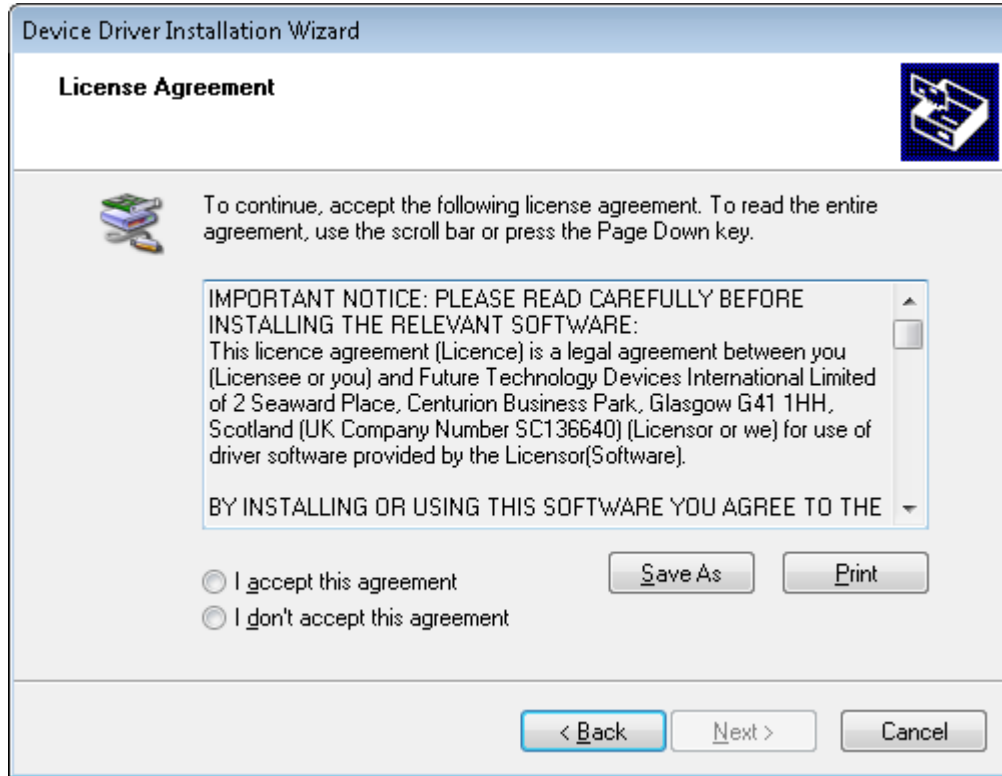

Figure 16. License Agreement for FTDI Driver

18. Click **Finish** to complete the Driver Installation.

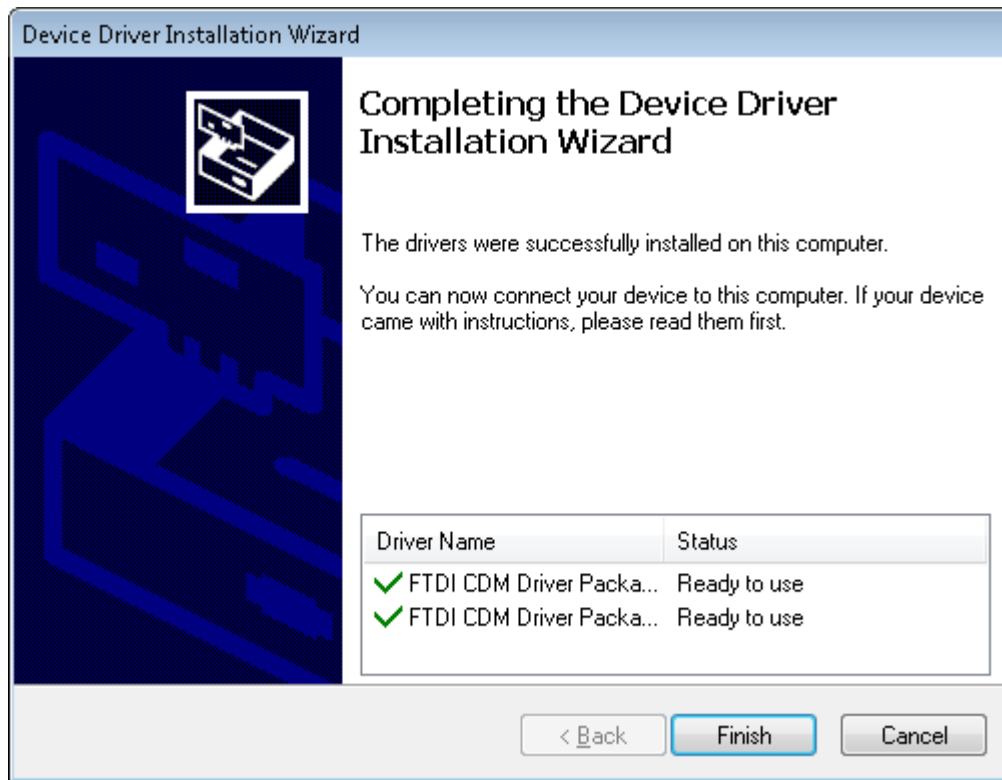

Figure 17. Driver Installation Completion

19. [Figure 18](#) appears denoting the completion of DRV8834 EVM GUI Installation. Click **Finish**.

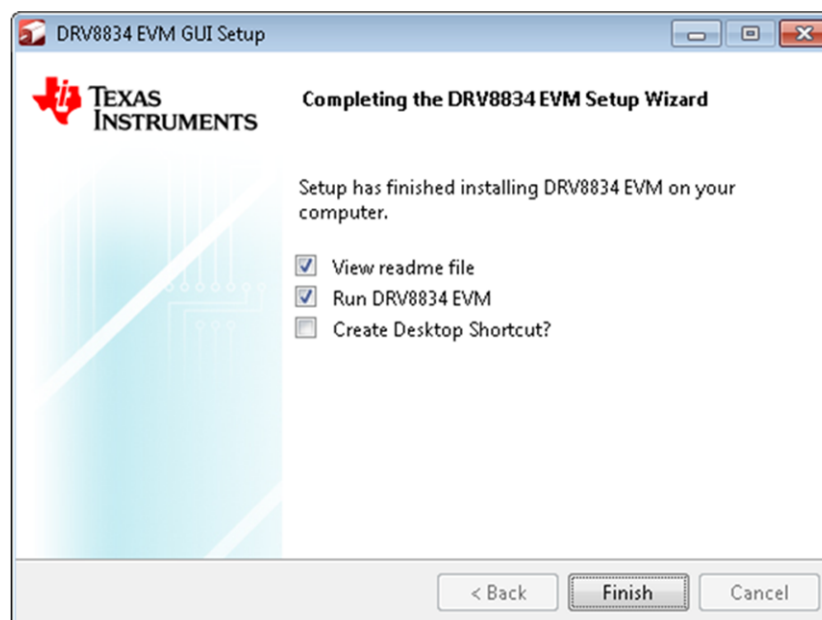

Figure 18. Installation Complete

20. A Readme window as shown in [Figure 19](#) appears displaying the link for LV 2014 RTE.

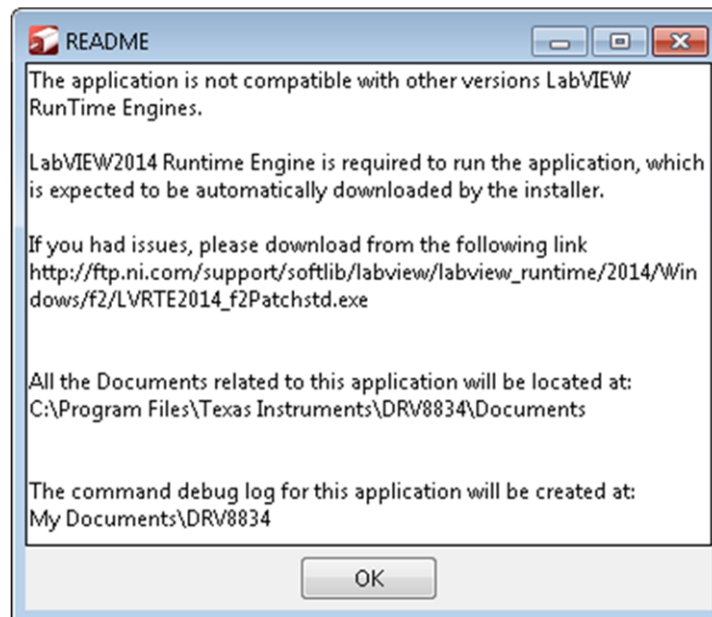

Figure 19. Readme Window

WARNING

The DRV8834 EVM GUI requires the LabVIEW Run-Time Engine 2014 to be installed before the GUI executes. Please note the application is not compatible with other versions of LabVIEW Runtime Engine.

You can download National Instruments LabVIEW Run-Time Engine 2014 from the below link:
[LabVIEW Run-Time Engine 2014](http://ftp.ni.com/support/softlib/labview/labview_runtime/2014/Windows/f2/LVRTE2014_f2Patchstd.exe)

NOTE: DRV8834 EVM GGUI executable has been built in LabVIEW 2014 (32-bit) version, and it expects the LabVIEW Run-Time Engine version to be LabVIEW Run-Time Engine (32-bit version).

4 The Windows Application

The DRV8834EVM Windows application is the software counterpart for the DRV8834 EVM. It allows the PC computer to connect to the MSP430F2617 microcontroller through an USB interface chip. Once connection is established and commands are sent, microcontroller takes care of configuring control signals and administering certain levels of automation, such as microstepping coordination, stepping rate acceleration and deceleration, ITrip configuration and PWM generation.

The graphical user interface (GUI) has been designed to allow for all of the DRV8834 device's functionality to be tested without having to intervene with the hardware, except for the adjusting of the reference voltage and decay selector switches.

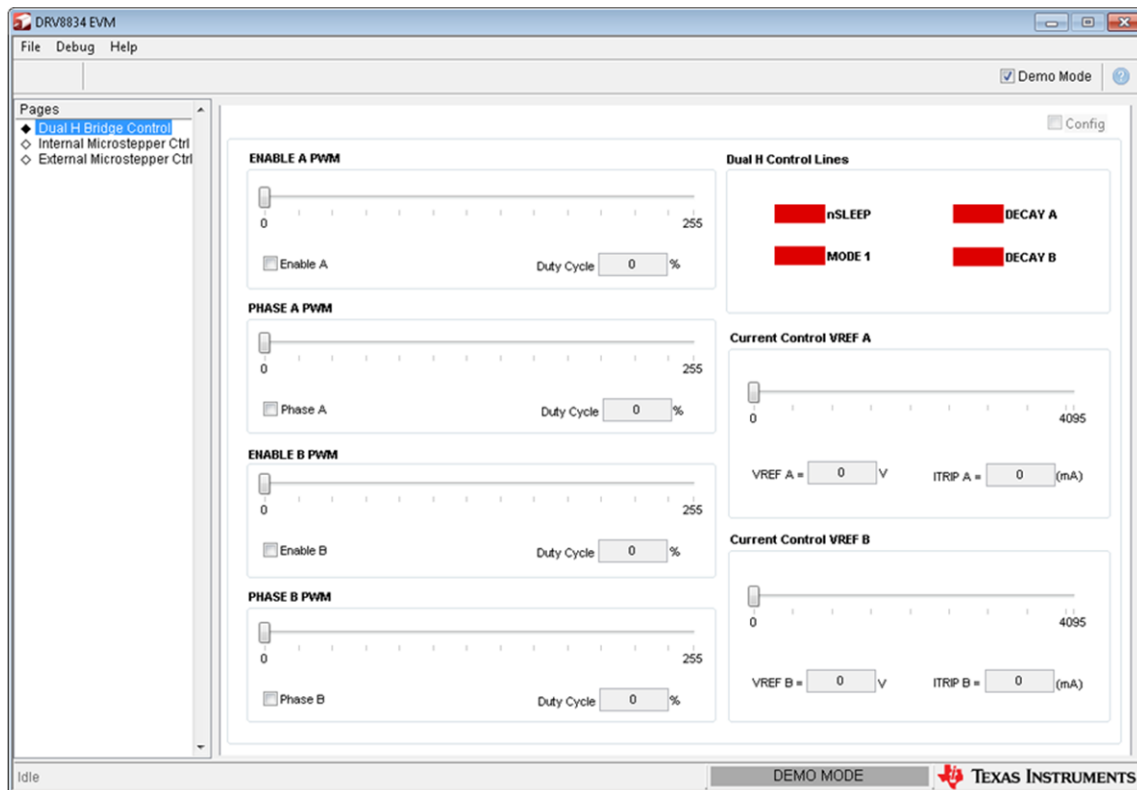

Figure 20. DRV8834EVM.exe Main Screen

All the control signals needed to control motor enablement (nENABLE or ENABLEx), direction of rotation (PHASEx or DIR), current control (VREFx) and PWM control for both enablement and direction control signals are made available throughout one of the three control tabs.

Each one of the three tabs will place the microcontroller and driver chip into one of the three operation modes. The three tabs are described below.

4.1 Dual H Bridge Mode

See [Figure 20](#).

While in this mode, the microcontroller treats the DRV8834 as a dual H-bridge driver with independent current regulation, motor enablement and phase control.

In this mode, the Windows application offers control to ENABLE each of the two motors and control the rotation direction. It also allows control of the speed and/or direction by offering access to a PWM resource to each of the ENABLEx and PHASEx signals. Both H-bridges can be programmed with a current regulation parameter by moving the VREFx slider. Other control signals are offered in the form of check boxes.

4.1.1 Internal Microstepper Control

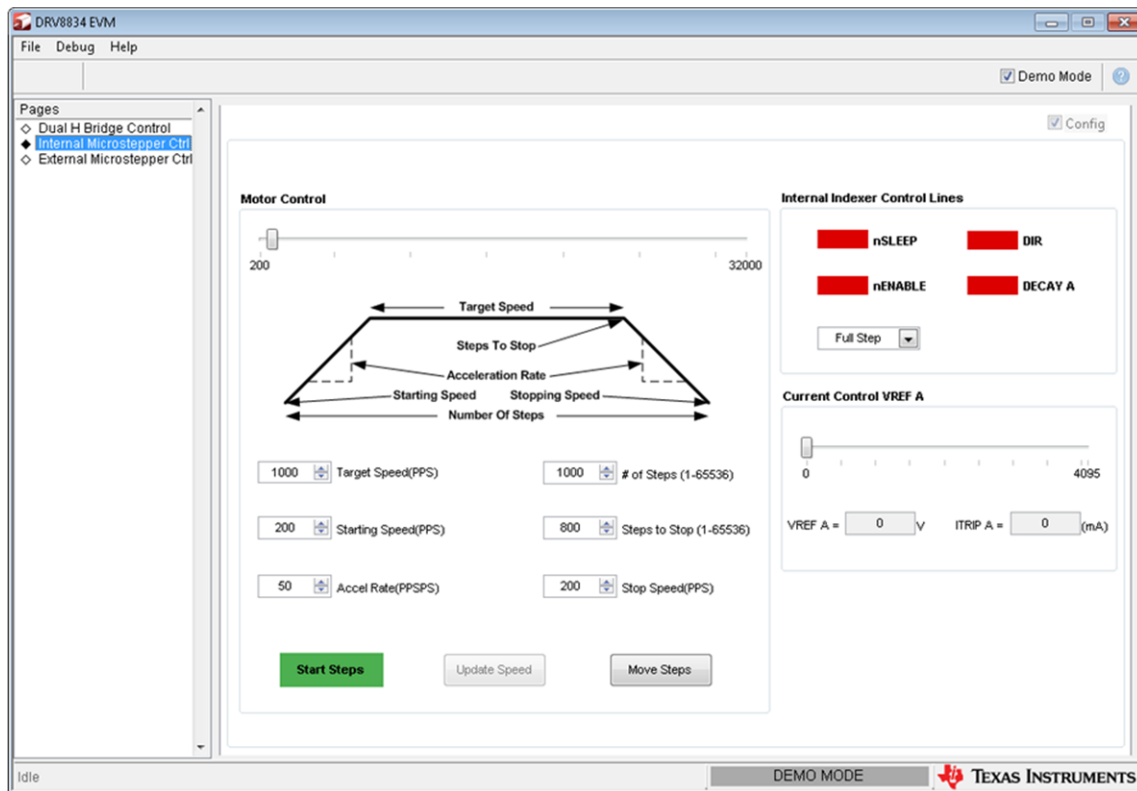

Figure 21. Internal Microstepper Control

While in this mode, the microcontroller treats the DRV8834 as an internal indexer microstepper with up to 32 degrees of microstepping driver.

In this mode, the Windows application offers control to ENABLE the driver, change motor rotation, select current regulation decay, select degrees of microstepping resolution and modify maximum current programming.

The Windows application also offers access to a series of sophisticated algorithms which allow the stepper motor actuation in both continuous rotation as well as position control mode. The algorithms offer accurate acceleration and deceleration profiles which help in the obtaining of better motion quality and performance.

4.1.2 External Microstepper Control

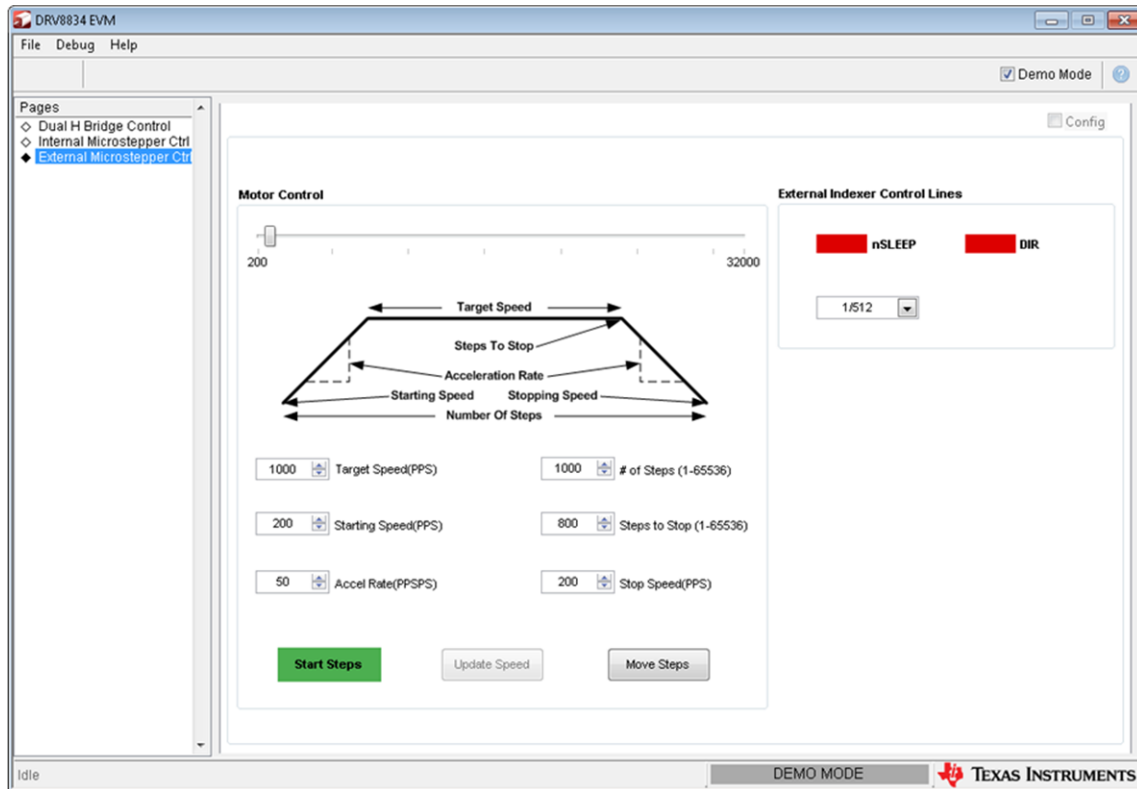

Figure 22. External Microstepper Control

While in this mode, the microcontroller treats the DRV8834 as a dual H-bridge driver with independent current regulation, motor enablement and phase control. Different than the dual H-bridge control mode in which two DC motors can be driving, while in this operation style, the microcontroller will recognize commands to issue high resolution microstepping commutation into a bipolar stepper motor.

In this mode, the Windows application offers control to change motor rotation and select degrees of microstepping resolution. The decay is programmed into the microcontroller high resolution microstepping algorithm to follow sine wave shape generation (slow decay while on quadrants 1 and 3, and mixed decay while on quadrants 2 and 4). Current is set to 1.5-A sine wave peak. To change the maximum current, the firmware’s internal look up table must be modified.

The Windows application also offers access to the same series of sophisticated algorithms which allow the stepper motor actuation in both continuous rotation as well as position control mode. The algorithms offer accurate acceleration and deceleration profiles which help in the obtaining of better motion quality and performance.

4.2 The CONFIG Control Signal

In this Windows application, the CONFIG control signal is not made available to the user. The application will modify the control signal according to which TAB is selected. When the communications are made and any tab gains focus, a serial command is sent to the microcontroller to set the CONFIG control signal accordingly. If the COM Port is not open, the serial command pertaining to this configuration is not sent.

4.3 Configuring Switches

Although the proper setting of the CONFIG control signal is made automatically, the EVM switches must still be properly configured if correct operation is to be observed. Failure to properly set these switches will result in problems with the current regulation and stepper motor functioning.

The following table shows the recommended switch positions as a different tab is selected. "Required" implies that the wrong operation will be observed if not followed. Optional implies that any other source (like the pot or an external signal) can be used, although control through the Windows application will be lost.

Table 2. Recommended Switch Positions

	DUAL H-BRIDGE	INTERNAL INDEXER	EXTERNAL INDEXER
BDECAY	MSP430 (optional)	MSP430 (optional)	MSP430 (required)
ADECAY	MSP430 (optional)	MSP430 (optional)	MSP430 (required)
BVREF	MSP430 (optional)	AVREF (required)	MSP430 (required)
AVREF	MSP430 (optional)	MSP430 (optional)	MSP430 (required)

4.4 Menu Options

- .

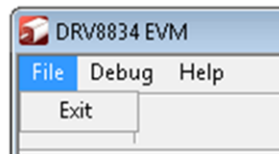

Figure 23. File Menu

- Debug - The Debug option can be used for the following operations.

Figure 24. Debug Menu

- - Demo - By selecting the Demo in the submenu, the GUI runs in simulation mode, and by unselecting it, the GUI runs in connected mode.
 - Log to File - The log to file submenu is used to log the GUI activities to a log file that is specified.
 - Debug log - The Debug log option enables to log all the activities of the user. If that is not selected, only the high-level operations log.
- Help
 - Clicking the About in the Help Menu

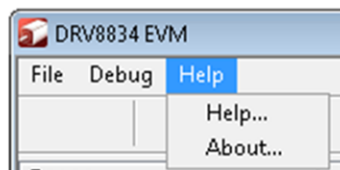

Figure 25. Help Menu

- The About Page provides the details like the Name of the GUI, GUI version, Supported OS and Copyright Information.



Figure 26. About Page

4.5 DRV8834 GPIO Control Signals

Once the application is communicating with the interface board, the control signals can be actuated by checking or un-checking boxes on any of the respective control signals frames.

Functionality of control signals is as follows. A checked box translates to a HI level on the respective control signal. Un-checked boxes translate to a LO level on the respective control signals.

4.6 Updating DAC Output for Current Control (VREF)

During evaluation, the user may want to study the operation of the ITRIP regulation scheme. Both MSP430F2617 MCU DAC channels can be controlled through the provided sliders. Moving these sliders will result on the regulated current to be directly proportional to the slider position per Equation 1.

$$I_{TRIP} = \frac{xVREF}{5 \cdot R_{SENSE}}, \text{ with } R_{SENSE} = 0.2 \Omega \tag{1}$$

It must be noted, however, that during stepper actuation with the external indexer method, the DAC channels are controlled by the microcontroller's microstepping application.

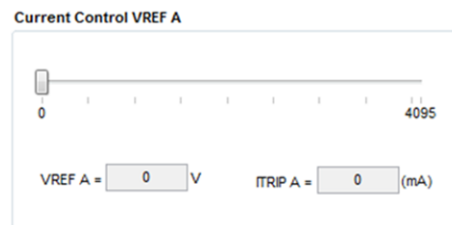

Figure 27. Current Control (VREF)

The 12-bit DAC channels 0/1 are connected to the DRV8834 VREF analog inputs VREF. Changing the DAC digital value from 0 to 4095, changes the analog voltage at the respective VREF pin from 0 V to 2.5 V respectively. See Equation 2.

$$V_{REF} = DAC_VALUE \cdot \frac{2.5 V}{4095} \tag{2}$$

Where VREF is the MCU DAC output voltage into the DRV8834 device and DAC_VALUE is a number from 0 to 4095 as, in this case, specified by the slider position.

4.7 Stepper Control

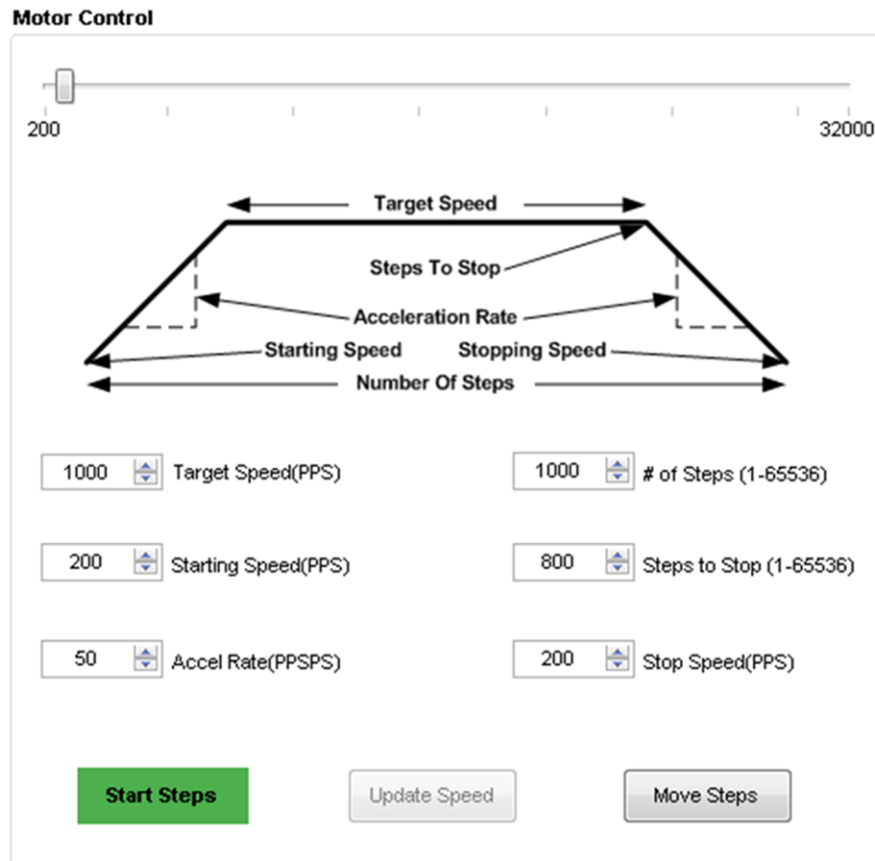

Figure 28. Motion Control

The Windows application has an area which offers access to a series of very useful stepper control algorithms. The user can control motor enablement, rotation rate, direction of rotation, current decay mode during microstepping, microstepping resolution (from full step to 32 degrees of microstepping in internal indexer mode or half step to 512 degrees of microstepping on external indexer mode) and number of steps the motor will move.

Motor motion can only happen by using an acceleration profile which will be detailed later on. A detailed explanation of each stepper control section follows.

4.7.1 Motion Control Frame

This frame allows the configuration and running of the stepper with the direction as specified by the DIR checkbox, with the current decay mode as specified under the Decay checkbox and the microstepping resolution as specified under the Microstepping Resolution drop down box.

The Motion Control frame gathers user information regarding stepping rate, or motor speed. An acceleration profile is employed to start at a programmable speed and increase stepping rate until reaching the programmable desired speed.

An internal 8-MHz timer is used to measure time and generate the steps on a timely manner. The Windows application will transform the entered number of PPS and transform it into the respective clock cycles needed for the timer to generate accurate STEP pulse timing.

The acceleration profile is coded inside of the microcontroller to accept both the starting speed PPS and target speed PPS as a clock cycle number. When the start steps command is issued (Starts Steps button is pressed), an interrupt service routine (ISR) generates steps at a rate specified by the start speed PPS parameter.

The very same start steps command computes how frequent automatic speed updates are issued and a second timer is used to change the speed according to the programmed acceleration rate profile.

Once the target speed PPS is reached, the acceleration profile ends and the motor stays running until the stop stepper command is issued (Stop Steps button). When the stepper is commanded to stop, the controller does exactly as it did while accelerating, but in reverse as to achieve deceleration until the stop speed PPS is reached, in which case the motor fully stops.

A second motor actuation is provided by the move steps command in which a programmed number of steps are issued and then the motor stopped. The acceleration and deceleration profiles work similarly as before, except when the deceleration starts to happen and when the motor actually stops are a function of the steps to stop and deceleration rate parameters.

Figure 29 shows the acceleration profile and the role each parameter plays during speed computation.

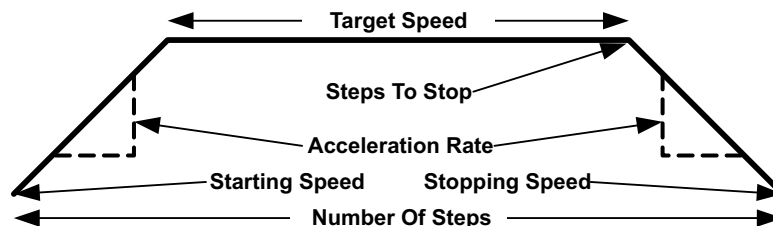

Figure 29. Acceleration Profile

The following controls are available within the motor control frame:

Start Speed PPS: Number of pulses per second (or full steps per second) at which the motor will rotate at the beginning of operation. The SW will only allow a number as small as 200 PPS and can be taken to a number as large as 65535 PPS.

Target Speed PPS: Number of pulses per second (or full steps per second) at which we want the motor to operate. The acceleration profile will start from the start speed PPS and increase stepping rate until reaching the desired speed PPS. The SW will only allow a number as small as 200 PPS and can be taken to a number as large as 65535 PPS.

Acceleration Rate (0-5000): A number from 0 to 5000 which acts as a stepping rate modifier to increase the start speed PPS up to target speed PPS.

Stop Speed PPS: Number of pulses per second (or full steps per second) at which the motor will stop rotating after the stop stepper command is invoked and the deceleration profile is issued. The deceleration profile modifies the stepper speed from the target speed and into the stop speed.

4.8 Move Steps Frame

If the user desires to move the stepper a certain number of steps, this can be easily accomplished by using the move steps function. Parameters from the other frames are reused and its utilization is as explained previously. Two new parameters have been added to properly control the limited number of steps actuation.

Number of Steps: Amount of steps the controller will issue.

Steps to Stop: The controller is continuously monitoring the step being issued and when the current step is equal to the steps to stop parameter, a deceleration profile is issued. If steps to stop is larger than the number of steps, then the motor stops abruptly and without undergoing a deceleration profile.

When a deceleration profile is issued, the controller decreases the speed until reaching the stop speed value. If the number of steps parameter is met before the deceleration profile is complete, then the motor stops at the current speed. If the stop speed is met before all the number of steps are issued, then the motor rotates at the stop speed value until all the steps are executed.

Ideally, the system must be tuned to resemble as much the case in which the controller executes all the commanded steps at a speed as close as possible to the stop speed. In the event this is not possible, due to the particular parameters being chosen, stopping the motor at a speed very close to the stop speed is often good enough to ensure good motion quality and application performance.

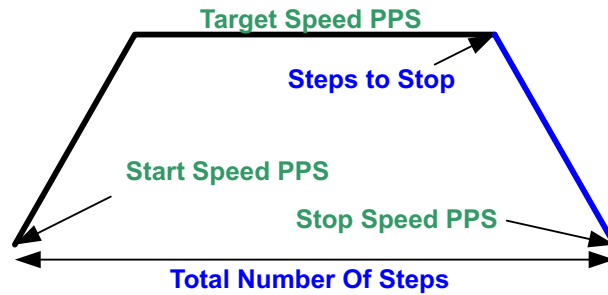

Motor Reaches Stop Speed at the Stop Speed

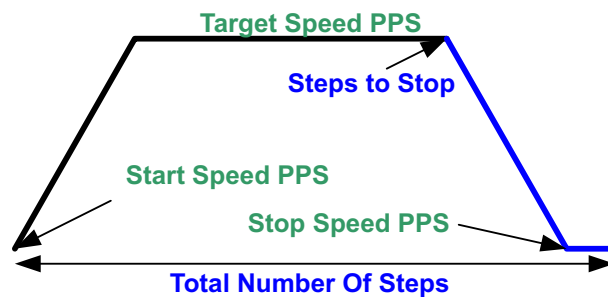

Motor Reaches Stop Speed before the Stop Speed is reached

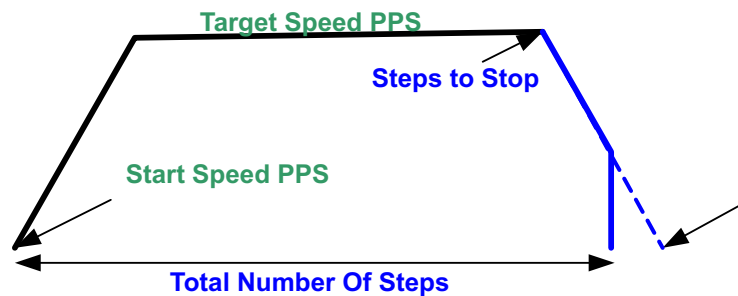

Motor runs out of Steps before reaching Stop Speed

Figure 30. Move Steps

4.8.1 Microstepping Resolution

Segmenting a full step into microsteps can be achieved by how many times we can divide the current regulation magnitude. The DRV8834 device offers the flexibility of using either internal indexing with up to 32 degrees of microstepping for the simplest implementation, or infinite degrees of microstepping when using the an external reference voltage source.

The Microstepping Resolution drop down box gives the user the option to change the full step divider factor so that microsteps from half step to 512 degrees of microstepping are obtained, depending on the chosen operating mode.

5 Schematics and Bill of Materials

5.1 Schematics

The following pages contain the schematics for the DRV8834EVM.

The DRV8834EVM schematics are also available in the form of a PDF file (SCH.pdf) inside the EVM_Related folder on the downloadable EVM software package.

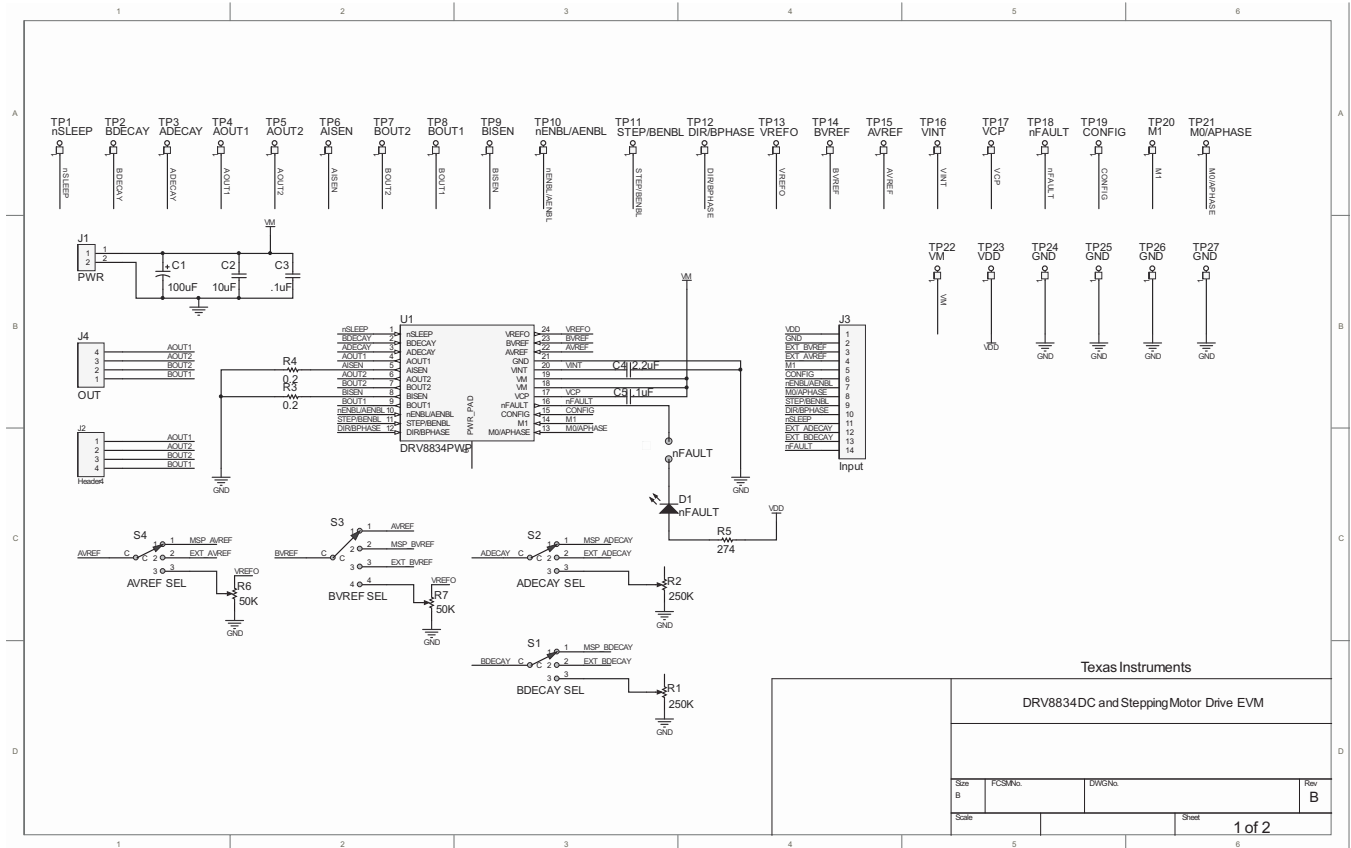

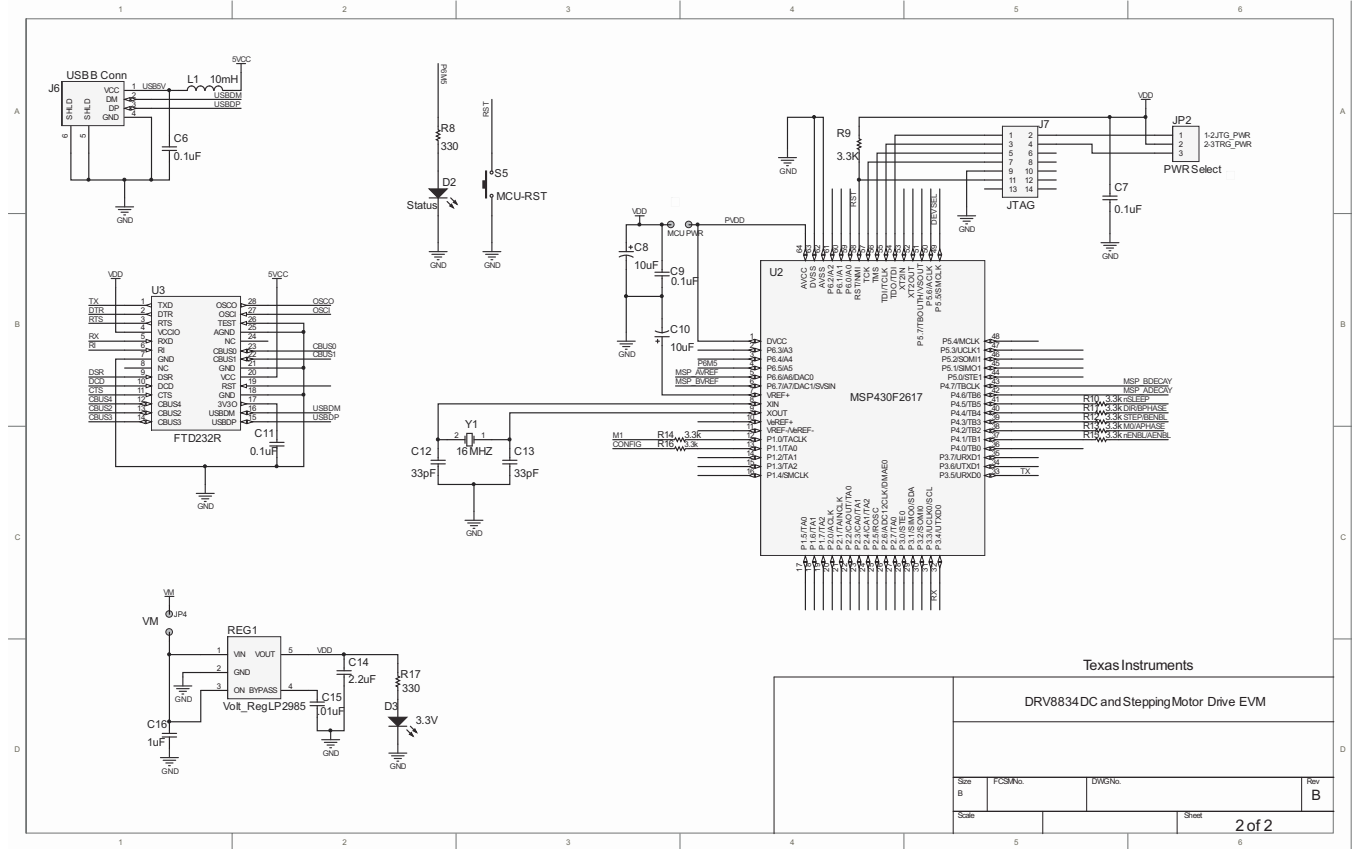

Texas Instruments			
DRV8834 DC and Stepping Motor Drive EVM			
Size B	PCSN: B	DWGNo. B	Rev B
Scale	Sheet	2 of 2	

5.2 Bill of Materials

DESIGNATOR	DESCRIPTION	MANUFACTURER	MFG PART NUMBER	VALUE	QUANTITY
C1	Polarized Capacitor (Radial)	Nichicon	RNE1C101MDS1PX	100 uF	1
C2	Capacitor	TDK Corporation	C2012X5R1C106M	10 uF	1
C3, C5	Capacitor	TDK Corporation	C1608X7R1E104K	.1 uF	2
C4	CAP CER 2.2 UF 10V Y5V 0603	TDK Corporation	C1608Y5V1A225Z	2.2 uF	1
C6, C7, C9, C11	CAP .10 UF 50 V CERAMIC X7R 0805	Kemet	C0805C104K5RACTU	0.1 uF	4
C8, C10	10 uF, 25 V Electrolytic Cap (Radial)	Nichicon	UVR1E100MDD	10 uF	2
C12, C13	CAP CERAMIC 33PF 50V NPO 0805	Yageo	CC0805JRNPO9BN330	33 pF	2
C14	Capacitor	TDK Corporation	C1608X5R0J225K	2.2 uF	1
C15	Capacitor	Murata Electronics North America	GRM188R71E103KA01D	.01 uF	1
C16	Capacitor	TDK Corporation	C1608Y5V1C105Z	1 uF	1
D1, D2, D3	LED RED CLEAR 1206 SMD	Stanley Electric & Co	HBR1105W-TR	LED RED	3
J1	TERM BLOCK 5.08 MM VERT 2POS PCB	On Shore Technologies	OSTTA024163		1
J2, J5		Sullins Connector Solutions	PBC02SAAN		2
J3	CONN HEADER .100 SINGL STR 14POS	Sullins Connector Solutions	PBC14SABN		1
J4	TERM BLOCK 5.08 MM VERT 4POS PCB	On Shore Technology Inc	OSTTA044163		1
J6	CONN USB RT ANG RECPT TYPE B BLK	Molex	67068-8000	USB B	1
J7	CONN HEADER .100 DUAL STR 14POS	Sullins	PBC07DAAN	14 Pos Header	1
JP1, JP3	Two Pin Jumper	Sullins Connector Solutions	PBC02SAAN	0.230" (5.84 mm)	2
JP2	CONN HEADER .100 SINGL STR 3POS	Sullins	PBC03SAAN	3 Pos Header	1
JP4	Two Pin Jumper	Phoenix Contact	1945096	NA	1
L1	Ferrite Bead 1.5A 40 ohm 0805 SMD	Laird-Signal Integrity Products	MI0805K400R-10	10 mH	1
R1, R2	TRIMMER 10K OHM 0.25W TH	Murata Electronics North America	PV37Y254C01B00	250 K	2
R3, R4	RES .2OHM 2W 1% 2512 SMD	Stackpole	CSRN2512FKR200	0.2	2
R5	Resistor	Panasonic - ECG	ERJ-6ENF2740V	274	1
R6, R7	TRIMMER 10K OHM 0.25W TH	Murata Electronics North America	PV37Y503C01B00	50K	2
R8, R17	RES 330 OHM 1/8W 5% 0805 SMD	Yageo	RC0805JR-07330RL	330	2
R9	RES 3.3K OHM 1/8W 5% 0805 SMD	Yageo	RC0805JR-073K3L	3.3K	1
R10, R11, R12, R13, R14, R15, R16	Resistor	Panasonic - ECG	ERJ-3GEYJ332V	3.3k	7
REG1	VoltageRegulator	Texas Instruments	LP2985-50DBVR		1
S1, S2, S4		Copal Electronics	SS-10-23NP-LE		3
S3		Copal Electronics	S-2150		1
S5	SWITCH LIGHT TOUCH 4.3 MM 100GF	Panasonic	EVQ-11A04M	Push Button	1
TP1, TP2, TP3, TP4, TP5, TP6, TP7, TP8, TP9, TP10, TP11, TP12, TP13, TP14, TP15, TP16, TP17, TP18, TP19, TP20, TP21	Glass Beaded Test Point	Kobiconn	151-101-RC	WHITE	21
TP22	Glass Beaded Test Point	Kobiconn	151-107-RC	WHITE	1
TP23	Glass Beaded Test Point	Kobiconn	151-107-RC	RED	1

DESIGNATOR	DESCRIPTION	MANUFACTURER	MFG PART NUMBER	VALUE	QUANTITY
TP24, TP25, TP26, TP27	Glass Beaded Test Point	Kobiconn	151-103-RC	BLACK	4
U1	Stepping and DC motor Driver	Texas Instruments			1
U2	IC MCU 16BIT 55K FLASH 64-LQFP	Texas Instruments	MSP430F2617TPMR	MSP430 MCU	1
U3	USB Chip	FTDI	FT232RL R	USB Driver	1
Y1	CRYSTAL 8.00 MHZ 20PF 49US	ECS Inc.	ECS-160-20-4X	Crystal	1

IMPORTANT NOTICE AND DISCLAIMER

TI PROVIDES TECHNICAL AND RELIABILITY DATA (INCLUDING DATASHEETS), DESIGN RESOURCES (INCLUDING REFERENCE DESIGNS), APPLICATION OR OTHER DESIGN ADVICE, WEB TOOLS, SAFETY INFORMATION, AND OTHER RESOURCES "AS IS" AND WITH ALL FAULTS, AND DISCLAIMS ALL WARRANTIES, EXPRESS AND IMPLIED, INCLUDING WITHOUT LIMITATION ANY IMPLIED WARRANTIES OF MERCHANTABILITY, FITNESS FOR A PARTICULAR PURPOSE OR NON-INFRINGEMENT OF THIRD PARTY INTELLECTUAL PROPERTY RIGHTS.

These resources are intended for skilled developers designing with TI products. You are solely responsible for (1) selecting the appropriate TI products for your application, (2) designing, validating and testing your application, and (3) ensuring your application meets applicable standards, and any other safety, security, or other requirements. These resources are subject to change without notice. TI grants you permission to use these resources only for development of an application that uses the TI products described in the resource. Other reproduction and display of these resources is prohibited. No license is granted to any other TI intellectual property right or to any third party intellectual property right. TI disclaims responsibility for, and you will fully indemnify TI and its representatives against, any claims, damages, costs, losses, and liabilities arising out of your use of these resources.

TI's products are provided subject to TI's Terms of Sale (www.ti.com/legal/termsofsale.html) or other applicable terms available either on ti.com or provided in conjunction with such TI products. TI's provision of these resources does not expand or otherwise alter TI's applicable warranties or warranty disclaimers for TI products.

Mailing Address: Texas Instruments, Post Office Box 655303, Dallas, Texas 75265
Copyright © 2019, Texas Instruments Incorporated