

## MOTOR SPECIFICATIONS

Part Number	<b>BL23E33-02D-03RO</b>
Length Dimension	82.5 mm [3.25 in]
Rated Voltage	48 VDC
Rated Output Power	120 W
Pole Number	8
Phase Number	3
Rated Speed	<b>4000 RPM</b>
Max Speed	5000 RPM
Rated Torque	0.29 N-m [41.07 oz-in]
Rated Current	3 Amps
Back EMF Constant	6.7 Vrms/krpm [9.48Vpeak/krpm]
Moment of Inertia	0.0000279kg-m <sup>2</sup> [1.53 oz-in <sup>2</sup> ]
Resistance	0.76 Ohms
Inductance	0.84 mH
Weight	1.08 kg [2.38 lb]

## ENCODER SPECIFICATIONS

Part Number	<b>E5 Encoder</b>
Type	Optical Incremental Encoder
Resolution	1000 CPR
Index	Yes
Output Type:	Differential

## MOTOR OPERATING SPECIFICATIONS

Hall Effect Angle	120°electrical Angle
Radial Play	0.002 in [0.05 mm] @ 0.99 lbs [0.45 kg]
End Play	0.003 in [0.08 mm] @ 99.21 lbs [45.00 kg]
Max. Radial Force	0.787 in [20.00 mm] @ 16.80 lbs [7.62 kg]
Max. Axial Force	3.37 lbs [1.53 kg]
Insulation Class	Class B
Dielectric Strength	500 VDC for 1 minute
Insulation Resistance	100 Ω min. 500 VDC
Ambient Operating Temp.	-20°C to 50°C
Storage Temperature	-20°C to 100°C
Humidity Range (%)	85% (RH) non-condensing

# DIMENSIONS

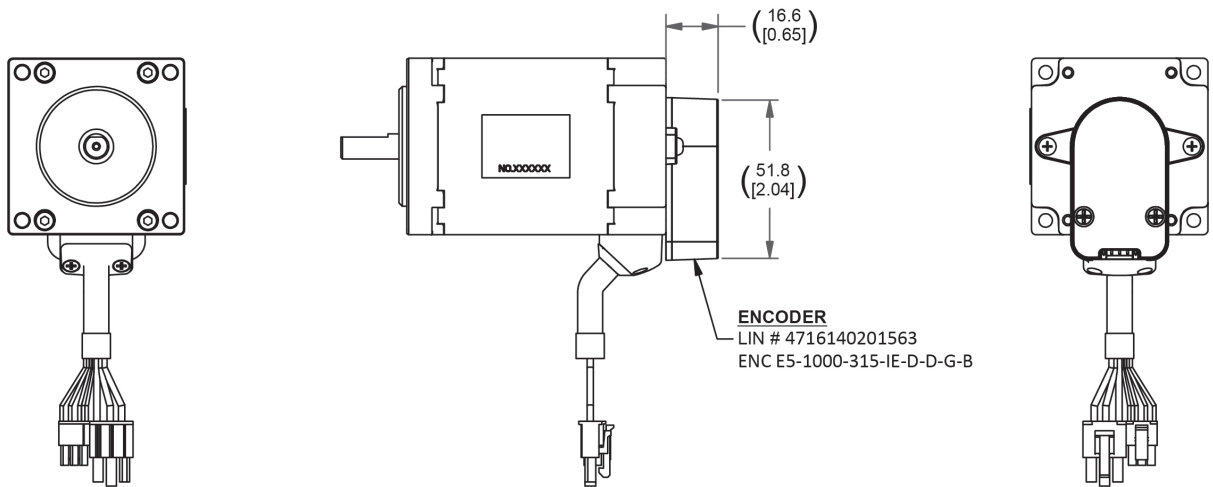
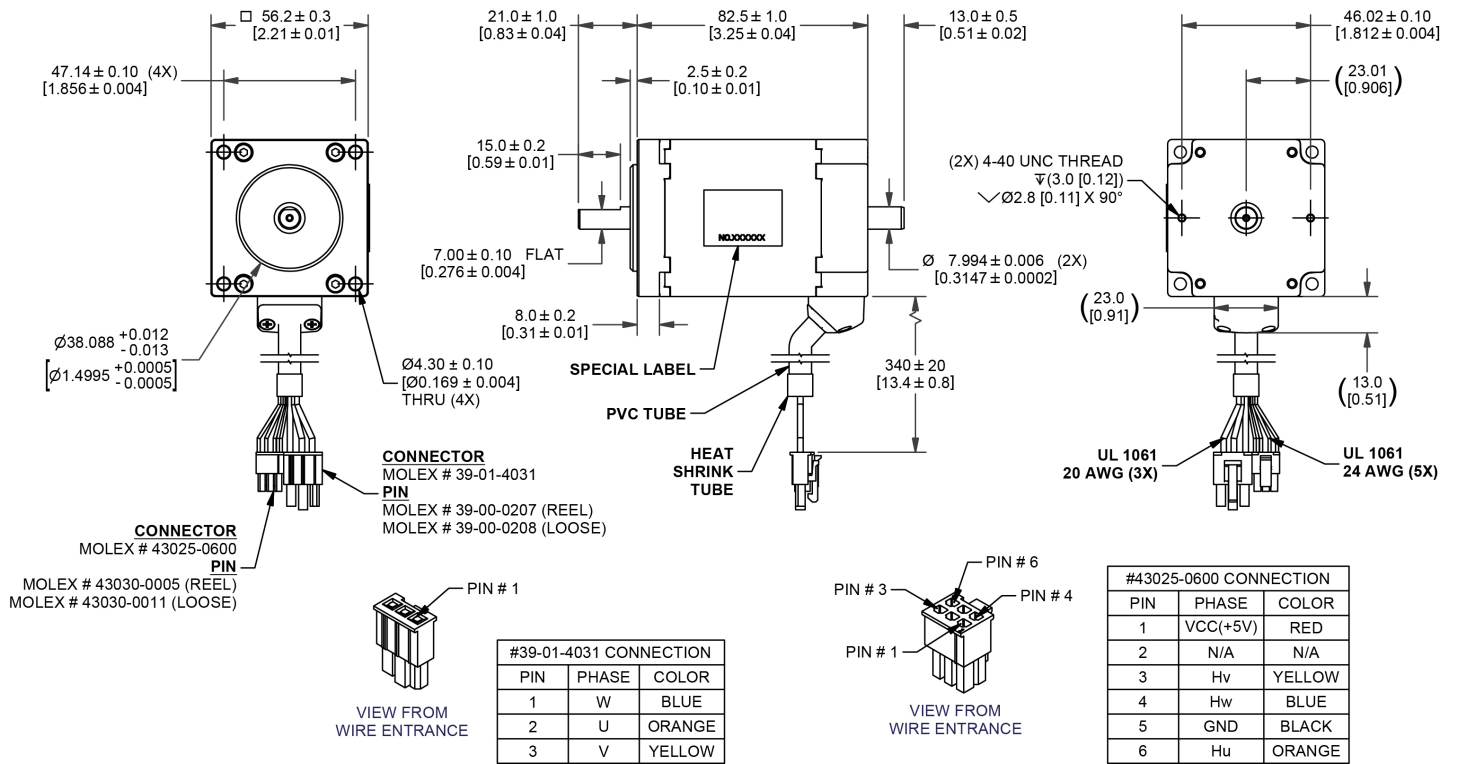

# RECOMMENDED PRODUCTS



BLDC DRIVER  
BLDC50-BL23E33-02



BLDC EXTENSION CABLE  
4201-100/300



E5 ENCODER CABLE  
CA-FC10-SH-NC-10-PKG

# PERFORMANCE CURVE

## BL23E33-02

Rated Voltage: 48 Volts, Rated Current: 3 Amps

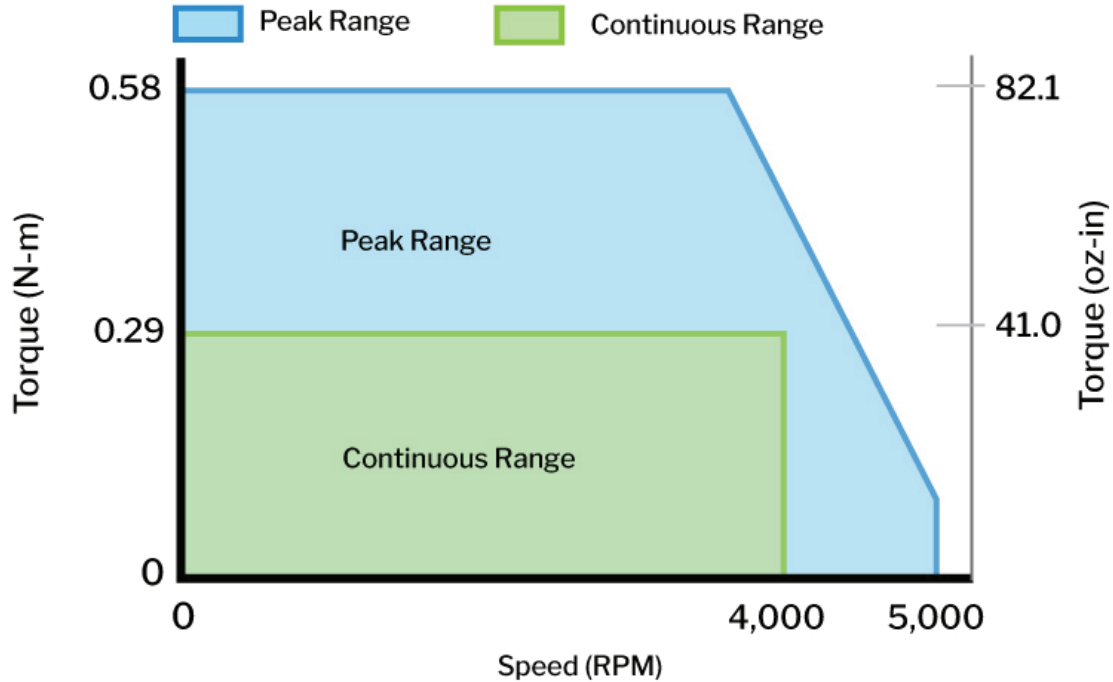

# OPERATION & USAGE TIPS

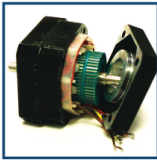

**Do not** disassemble motors; a significant reduction in motor performance will occur.

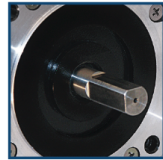

**Do not** machine shafts; this will have a negative effect on shaft run out and perpendicularity.

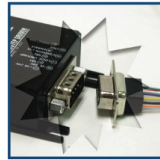

**Do not** disconnect motor from drive while in operation.

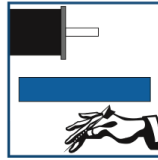

**Do not** use holding torque/detent torque of motor as a fail safe brake.



**Do not** hold motor by lead wires.



**Do not** exceed the rated current; this will burn the motor.

FAILURE TO COMPLY WITH THESE RECOMMENDATIONS WILL VOID ALL WARRANTY TERMS

# Motion Control, **Solved.**

## MOTOR ENGINEERING & MANUFACTURING



Optimized  
For Your  
Application



Quick  
Prototype  
Turnaround



Small Batch  
to OEM Volume  
Production



US Based  
Support &  
Manufacturing