



PE15N

Hardware Integration Guide

Version 2.4

global solutions: local support.

Americas: +1-800-492-2320

Europe: +44-1628-858-940

Hong Kong: +852-2923-0610

Embedded Wireless Solutions Support Center: <http://ews-support.lairdtech.com>

www.lairdtech.com/wireless

REVISION HISTORY

Version	Revision Date	Change Description	Approver
1.0	01/04/10	Initial version of the SDC-PE15N Hardware Integration Guide.	Ron Seide
1.01	03/03/10	Added RF Layout Design Guidelines section.	Ron Seide
1.02	04/09/10	Added Wi-Fi Certification information.	Ron Seide
1.03	05/04/10	Added note to Certified Antenna section regarding transmit power.	Ron Seide
1.04	05/12/10	Revised Mechanical drawing – added Antenna Port labels.	Ron Seide
1.05	06/16/10	Added links to TELEC test reports/certificates. Revised Pin Description table layout.	Ron Seide
1.06	11/10/11	Revised Pin table – removed references to 1.5V.	Andrew Chen
1.07	02/23/12	Added Current Consumption Standby numbers.	Andrew Chen
1.08	02/29/12	Added ESD Consideration information.	Andrew Chen
1.09	08/15/12	Added NCC compliance	Andrew Chen
2.0	11/6/12	Updated format (converted to Laird).	Andrew Chen
2.1	1/31/13	Updated 5 GHz Frequencies and Operating Channels	Andrew Chen
2.2	10/17/13	Removed references to summitdata.com	Sue White
2.3	12 Feb 2015	Updated Receiver Sensitivity numbers	Dale Chapman
2.4	26 Oct 2015	Added Approver column to Rev History table; fixed/removed internal links	Sue White

CONTENTS

Revision History	2
Contents	3
Scope	4
Operational Description.....	4
Block Diagram	5
Specifications	5
Pin Definitions	9
Mechanical Specifications.....	10
Connector Overview.....	10
Mounting.....	10
ESD consideration	11
RF Layout Design Guidelines	11
Regulatory	11
Certified Antennas.....	11
Documentation Requirements.....	12
FCC	12
Industry Canada	14
European Union	15
Declaration of Compliance	16

SCOPE

This document describes key hardware aspects of the SDC-PE15N embedded wireless LAN module. This document is intended to assist device manufacturers and related parties with integration of this module into their host devices. Data in this document are drawn from a number of sources and includes information found in the Broadcom BCM4322 data sheet issued in August of 2008.

The information in this document is subject to change without notice. Please contact Laird or visit the [PE15N page of the Laird website](#) to obtain the most recent version of this document.

OPERATIONAL DESCRIPTION

This device is an SDC-PE15N, an IEEE 802.11n-compliant Peripheral Components Interconnect Express (PCIe) Mini Card which operates in the 2.4 GHz and 5 GHz portions of the radio frequency spectrum.

The device is compliant with IEEE 802.11a, 802.11b, 802.11g, and 802.11n standards using Direct Sequence Spread Spectrum and Orthogonal Frequency Division Multiplexing. The device supports all 802.11a, 802.11b, and 802.11g data rates and select 802.11n data rates and automatically adjusts data rates and operational modes based on various environmental factors.



When operating on channels in the UNII-2 and UNII-2 Extended bands that are in the 5GHz portion of the frequency spectrum and are subject to Dynamic Frequency Selection requirements, the SDC-PE15N fully conforms to applicable regulatory requirements. In the event that specified types of radar are detected by the network infrastructure, the SDC-PE15N fully conforms to commands from the infrastructure for radar avoidance.

The SDC-PE15N is compliant with 32-bit PCIe Mini Card mechanical specifications and interfaces to host devices via a 52-pin edge connector. The device is based on the Broadcom BCM4322 chip which is an 802.n compliant integrated device providing a Media Access Controller (MAC), a Physical Layer Controller (PHY or baseband processor), and fully integrated dual-band radio transceiver that provides 2x2 antenna and MIMO support. The frequency stability for both 2.4 GHz (802.11b and 802.11g) and 5 GHz (802.11a) operation is +/- 20 ppm.

The PE15N has its own RF shielding and does not require shielding provided by the host device into which it is installed in order to maintain compliance with applicable regulatory standards. As such, the device may be tested in a standalone configuration via an extender card.

The device buffers all data inputs so that it will comply with all applicable regulations even in the presence of over-modulated input from the host device. Similarly, the SDC-PE15N incorporates power regulation to comply with all applicable regulations even when receiving excess power from the host device.

The SDC-PE15N provides two unique U.FL type antenna connectors to allow for diversity support when operating in 802.11a, 802.11b and 802.11g modes and 2 x 2 MIMO support when operating in 802.11n mode.

The device is labeled with all applicable regulatory information in a manner that's compliant with all regulatory standards. Regulatory operational requirements are included with this document and are to be incorporated into the operating manual of any device into which the SDC-PE15N is installed. The PE15N is designed for installation into mobile devices such as vehicle mount data terminals which typically operate at distances greater than 20 cm from the human body. See [Documentation Requirements](#) for more information.

BLOCK DIAGRAM

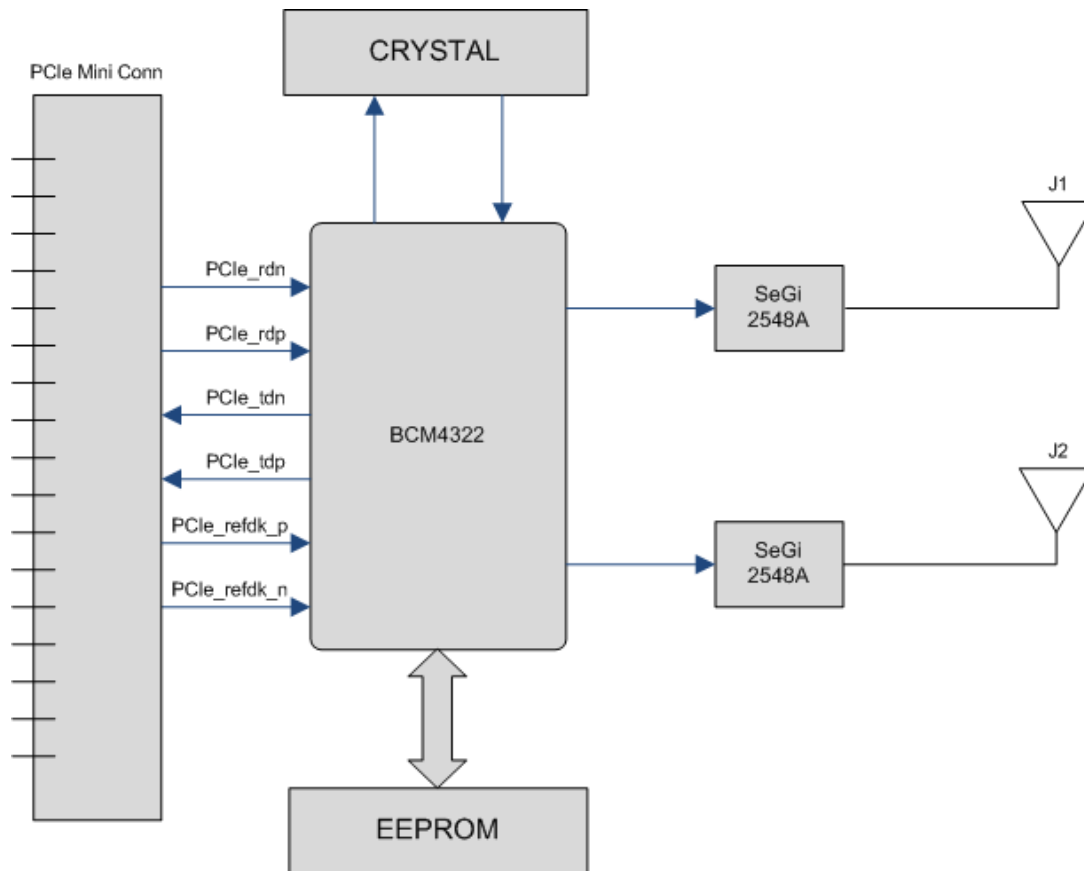

SPECIFICATIONS

Feature	Description
System Interface	32-bit Peripheral Component Interconnect Express (PCIe) Mini Card with 52 pin edge connector
Antenna Interface	2 U.FL (Hirose) connectors for 2 x 2 MIMO support
Chip Set	Broadcom BCM4322
Input Power Requirements	3.3 VDC +/- 10%
Current Consumption (At maximum transmit power setting)	Transmit: 600 mA (1980 mW) Receive: 91 mA (300 mW) Standby: 3 mA (10 mW)
Operating Temperature	-30° to 75°C (-22° to 167°F)
Operating Humidity	10 to 90% (non-condensing)
Storage Temperature	-40° to 80°C (-40° to 176°F)
Storage Humidity	10 to 90% (non-condensing)
Maximum Electrostatic Discharge	4 kV
Length	51 mm (2.01 in.)
Width	30 mm (1.18 in.)
Thickness	3.3 mm (0.13 in.)



Feature	Description
Weight	9 g (0.3 oz.)
Mounting	52 pin edge connector 2 Through Holes (non-metallic screw recommended)
Wireless Media	Direct Sequence-Spread Spectrum (DSSS) Orthogonal Frequency Divisional Multiplexing (OFDM)
Media Access Protocol	Carrier sense multiple access with collision avoidance (CSMA/CA)
Network Architecture Types	Infrastructure and ad hoc
Network Standards	IEEE 802.11a, 802.11b, 802.11d, 802.11g, 802.11h, 802.11i, 802.11n
Data Rates Supported	802.11a (OFDM): 6, 9, 12, 18, 24, 36, 48, 54 802.11b (DSSS): 1, 2, 5.5, 11 802.11g (OFDM): 6, 9, 12, 18, 24, 36, 48, 54 802.11n (OFDM, 20-MHz channels): 14, 29, 43, 58, 87, 116, 130, 144 802.11n (OFDM 40-MHz channels): 30, 60, 90, 120, 180, 240, 270, 300
Modulation	BPSK @ 1, 6, 9, 14, 30 Mbps QPSK @ 2, 12, 18, 29, 43, 60, 90 Mbps CCK @ 5.5, 11 Mbps 16-QAM @ 24, 36, 58, 87, 120, 180 Mbps 64-QAM @ 48, 54, 116, 130, 144, 240, 270, 300 Mbps
Regulatory Domain Support	FCC (Americas, Parts of Asia and Middle East) ETSI (Europe, Middle East, Africa and Parts of Asia) MIC (formerly TELEC) (Japan) KCC (Korea)
2.4 GHz Frequency Bands	ETSI 2.4 GHz to 2.483 GHz FCC 2.4 GHz to 2.473 GHz MIC 2.4 GHz to 2.495 GHz KCC 2.4 GHz to 2.483 GHz
5 GHz Frequency Bands	ETSI 5.15 GHz to 5.35 GHz 5.47 GHz to 5.725 GHz FCC 5.15 GHz to 5.35 GHz 5.47 GHz to 5.725 GHz 5.725 GHz to 5.82 GHz MIC 5.15 GHz to 5.35 GHz KCC 5.15 GHz to 5.35 GHz 5.725 GHz to 5.82 GHz
2.4 GHz, 20 MHz-wide Operating Channels	ETSI: 13 (3 non-overlapping) FCC: 11 (3 non-overlapping) MIC: 14 (4 non-overlapping)

Feature	Description
	KCC: 13 (3 non-overlapping)
5 GHz, 20 MHz-wide Operating Channels	ETSI: 19 non-overlapping FCC: 23 non-overlapping MIC: 8 non-overlapping KCC: 12 non-overlapping
5 GHz, 40 MHz-wide Operating Channels	ETSI: 9 non-overlapping FCC: 11 non-overlapping MIC: 4 non-overlapping
Transmit Power Settings	802.11a: 14 dBm (25 mW) 802.11b: 17 dBm (50 mW) 802.11g: 17 dBm (50 mW) 802.11n (20 MHz wide 2.4 GHz channel operation): 15 dBm (30 mW) 802.11n (40 MHz wide 2.4 GHz channel operation): 14 dBm (25 mW) 802.11n (20 MHz wide 5 GHz channel operation): 15 dBm (30 mW) 802.11n (40 MHz wide 5 GHz channel operation): 14 dBm (25 mW)
Typical Receiver Sensitivity	802.11a 6 Mbps -92 dBm 24 Mbps -84 dBm 54 Mbps -75 dBm (PER <= 10%) 802.11b 1 Mbps -96 dBm 11 Mbps -88 dBm (PER <= 10%) 802.11g 6 Mbps -90 dBm 24 Mbps -83 dBm 54 Mbps -73 dBm (PER <= 10%) 802.11n (20 MHz channels) 6.5 Mbps -90 dBm 39 Mbps -79 dBm 65 Mbps -70 dBm (PER <= 10%) 802.11n (40 MHz channels) TBD
Delay Spread	600 ns @ 1 Mbps 350 ns @ 12 Mbps 500 ns @ 2 Mbps 350 ns @ 18 Mbps 400 ns @ 5.5 Mbps 250 ns @ 24 Mbps 400 ns @ 6 Mbps 250 ns @ 36 Mbps 400 ns @ 9 Mbps 150 ns @ 48 Mbps 200 ns @ 11 Mbps 150 ns @ 54 Mbps

Note: Maximum transmit power varies according to individual country regulations. All values nominal, +/-2 dBm.

Note: All values nominal, +/-3 dBm.

*Note: We cannot currently test Typical Receiver Sensitivity for 802.11n due to lack of availability of an applicable AP (one that functions in **Greenfield mode**). We will have these numbers as soon as possible.*

Feature	Description
Security	Standards Wireless Equivalent Privacy (WEP) Wi-Fi Protected Access (WPA) IEEE 802.11i (WPA2) Encryption Wireless Equivalent Privacy (WEP, RC4 Algorithm) Temporal Key Integrity Protocol (TKIP, RC4 Algorithm) Advanced Encryption Standard (AES, Rijndael Algorithm) Encryption Key Provisioning Static (40-bit and 128-bit lengths) Pre-Shared (PSK) Dynamic 802.1X Extensible Authentication Protocol Types EAP-FAST PEAP-GTC EAP-TLS PEAP-MSCHAPv2 EAP-TTLS LEAP PEAP-TLS
Operating Systems Supported	Windows XP Professional and Embedded
Compliance	ETSI Regulatory Domain EN 300 328_ EN 301 489_ EN 301 893 (R&TTE Directive 3.2)/ EN 301 893 (DFS Test Report) EN 62311:2008 EN60950-1 EU 2002/95/EC (RoHS) FCC Regulatory Domain Part 15.247 Subpart C Part 15.407 Subpart E Industry Canada RSS-210 MIC Regulatory Domain Article 2 Item 19, Category WW (2.4Ghz Channels 1-13) Article 2 Item 19-2, Category GZ (2.4GHz Channel 14) Article 3 Item 19-3, Category XW (5150-5250 W52 & 5250-5350 W53) NCC Certification
Certifications	<u>Wi-Fi Alliance</u> 802.11a, 802.11b, 802.11g, 802.11n WPA Enterprise WPA2 Enterprise Cisco Compatible Extensions (Version 4)  
Warranty	3-Year Warranty
<i>All specifications are subject to change without notice</i>	

PIN DEFINITIONS

Pin #	Pin Name	I/O	Power Type	Description
1	WL_GPIO_1	O	VDDIO	Wake on Wireless – Not currently supported in the software. May be left open
2	VCC3_3			3.3V Module Power
3	WLAN_ACTIVE	O	VDDIO	Output to BT device. When high, indicates that WLAN is transmitting or receiving. Do not connect when not used
4	GND			Ground
5	BT_ACTIVE	I	VDDIO	Input from BT device. When high, indicates Bluetooth is transmitting or receiving. The Summit radio does not transmit when BT_ACTIVE is high. Tie to GND when not in use
6	No Connect			No Connect. Not Used. Leave Open (Float)
7	CLKREQ_L			Reference clock request signal
8	No Connect			Not Used. Leave Open (Float)
9	GND			Ground
10	No Connect			Not Used. Leave Open (Float)
11	REFCLK_N			Differential reference clock
12	No Connect			Not Used. Leave Open (Float)
13	REFCLK_P			Differential reference clock
14	No Connect			Not Used. Leave Open (Float)
15	GND			Ground
16	No Connect			Not Used. Leave Open (Float)
17	No Connect			Not Used. Leave Open (Float)
18	GND			Ground
19	No Connect			Not Used. Leave Open (Float)
20	RF_DISABLE_L			Module Disable
21	GND			Ground
22	PERST_L			Module Reset
23	PETn0			Differential receive
24	VAUX_3_3			Auxiliary 3.3 V Module Power
25	PETp0			Differential receive
26	GND			Ground
27	GND			Ground
28	No Connect			No Connect. Not Used. Leave Open (Float)
29	GND			Ground
30	No Connect			Not Used. Leave Open (Float)
31	PERn0			Differential transmit
32	No Connect			Not Used. Leave Open (Float)
33	PERp0			Differential transmit
34	GND			Ground
35	GND			Ground

Pin #	Pin Name	I/O	Power Type	Description
36	No Connect			Not Used. Leave Open (Float)
37	GND			Ground
38	No Connect			Not Used. Leave Open (Float)
39	VCC3_3			Primary 3.3 V Module Power
40	GND			Ground
41	VCC3_3			Primary 3.3 V Module Power
42	No Connect			Not Used. Leave Open (Float)
43	No Connect			Not Used. Leave Open (Float)
44	WL_LED_ACT	O	VDDIO	WLAN LED Activity Indicator
45	No Connect			Not Used. Leave Open (Float)
46	No Connect			Not Used. Leave Open (Float)
47	No Connect			Not Used. Leave Open (Float)
48	No Connect			No Connect. Not Used. Leave Open (Float)
49	No Connect			Not Used. Leave Open (Float)
50	GND			Ground
51	No Connect			Not Used. Leave Open (Float)
52	VCC3_3			Primary 3.3 V Module Power

MECHANICAL SPECIFICATIONS

Connector Overview

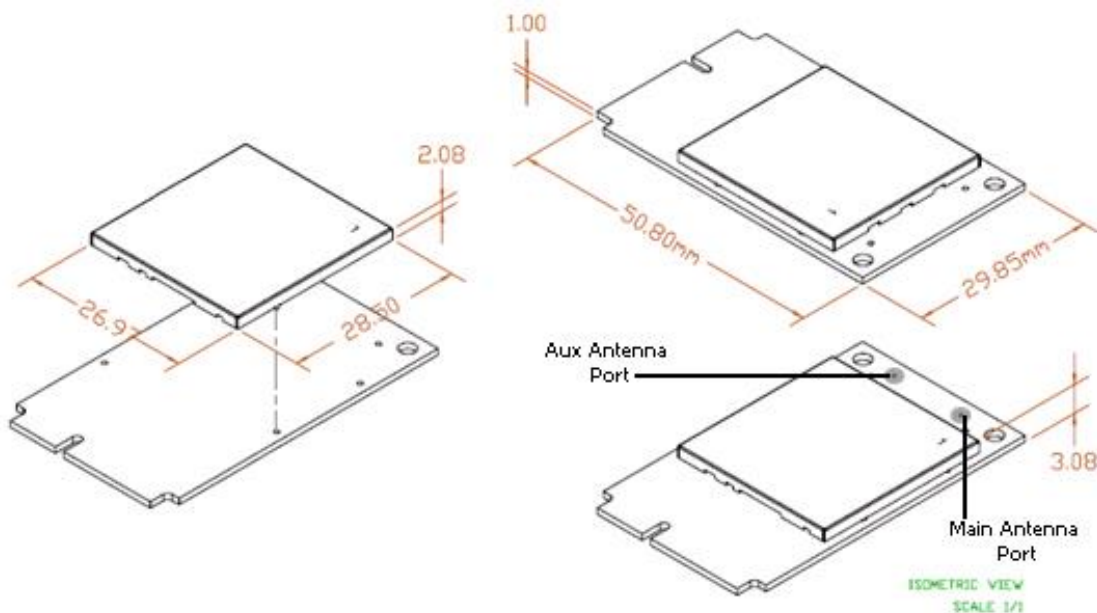

Mounting

The SDC-PE15N is fully compliant with the PCIe full length Mini Card mechanical specifications. As such, it may be connected to the host device via any standards-compliant host connector. It may be mounted to host devices using a variety of standards-compliant latches and or via the two mounting holes located on the top end of the device.

ESD Consideration

The two mounting holes are also for the purpose of ESD (electrostatic discharge) consideration. To handle maximum ESD levels, two screws must be used on the SDC-PE15N with proper grounding (connected to the customer's main board ground and the case ground of the device).

RF LAYOUT DESIGN GUIDELINES

The following is a list of RF layout design guidelines and recommendation when installing a Summit radio into your device. Please note that because each device is different, Summit cannot approve and/or guarantee the outcome of your specific design.

- Do not run antenna cables directly above or directly below the radio.
- Do not place any parts or run any high speed digital lines below the radio.
- If there are other radios or transmitters located on the device (such as a Bluetooth radio), place the devices as far apart from each other as possible.
- Ensure that there is the maximum allowable spacing separating the antenna connectors on the Summit radio from the antenna. In addition, do not place antennas directly above or directly below the radio.
- Summit recommends the use of a double shielded 32 AWG cable for the connection between the radio and the antenna elements.

REGULATORY

Note: Operation in the 5150-5250 MHz band is limited to indoor use only.

Certified Antennas

The SDC-PE15N provides two Hirose U.FL type antenna connectors to support transmit and receive diversity. For single antenna, non-diversity applications, OEMs are advised to use the Main (not Aux) antenna connector and should disable transmit and receive diversity from the Global tab of the Summit Client Utility (SCU) software utility.

The SDC-PE15N has been tested to the regulatory standards defined in the *Certifications* section of the Specifications table above. These tests were conducted with the following antennas:

Summit SDC-CF22G Antenna

- Form Factor: Chip Antenna on PCB
- Type: Dipole
- Maximum 2.4 GHz Gain: 0 dBi

Cisco AIR-ANT 4941

- Form Factor: Whip
- Type: Dipole
- Maximum 2.4 GHz Gain: 2.2 dBi
- Tested and Certified 2.4 GHz Transmit Power: 90% of maximum setting

Radiall Larson Dipole

- Form Factor: Whip
- Type: Dipole
- Maximum 2.4 GHz Gain: 1.6 dBi (not used during testing)
- Maximum 5 GHz Gain: 5 dBi

HUBER+SUHNER

- Form Factor: Whip
- Type: Monopole
- Maximum 2.4 GHz Gain: 3 dBi
- Maximum 5 GHz Gain: 6.5 dBi
- Tested and Certified 2.4 GHz Transmit Power: 95% of maximum setting
- Tested and Certified 5 GHz Transmit Power: 100% of maximum setting

Note: The formal test reports for the SDC-PE15N show transmit power was decreased to less than 100% on 2.4 GHz edge channels. Summit has made these transmit power reductions in firmware for the edge channels. Integrators do not need to reduce transmit power on a channel-by-channel basis to account for band edge regulations.

Antennas of differing types and higher gains may be integrated as well. With the Summit Manufacturing Utility software utility, OEMs may reduce the transmit power of the SDC-PE15N to account for higher antenna gain when necessary. In some cases, OEMs may be able to reduce certification efforts by using antennas that are of like type and equal or lesser gain to the above listed antennas.

Documentation Requirements

In order to maintain regulatory compliance, when integrating the SDC-PE15N into a host device and leveraging Summit's grants and certifications, it is necessary to meet the documentation requirements set forth by the applicable regulatory agencies. The following sections (FCC, Industry Canada, and European Union) outline the information that must be included in the user's guide and external labels for the host devices into which the SDC-PE15N is integrated.

FCC

User's Guide Requirements

As outlined in the Operational Description, the SDC-PE15N complies with [FCC Part 15 Rules](#) for a Limited Modular Approval. To leverage Summit's grant, the two conditions below must be met for the host device into which the SDC-PE15N is integrated:

1. The antenna is installed with 20 cm maintained between the antenna and users.
2. The transmitter module is not co-located with any other transmitter or antenna that is capable of simultaneous operation. As long as the two conditions above are met, further *transmitter* testing is typically not required. However, the OEM integrator is still responsible for testing its end-product for any

additional compliance requirements required with this module installed, such as (but not limited to) digital device emissions and PC peripheral requirements.

IMPORTANT!

In the event that the two conditions above *cannot be met* (for example certain device configurations or co-location with another transmitter), then the FCC authorization is no longer considered valid and the FCC ID *cannot* be used on the final product. In these circumstances, the OEM integrator will be responsible for re-evaluating the end product (including the transmitter) and obtaining a separate FCC authorization.

When using Summit's FCC grant for the SDC-PE15N, the integrator must include specific information in the user's guide for the device into which the SDC-PE15N is integrated. The integrator must not provide information to the end user regarding how to install or remove this RF module in the user's manual of the device into which the SDC-PE15N is integrated. The following FCC statements must be added in their entirety and without modification into a prominent place in the user's guide for the device into which the SDC-PE15N is integrated:

"IMPORTANT NOTE: To comply with FCC RF exposure compliance requirements, the antenna used for this transmitter must be installed to provide a separation distance of at least 20 cm from all persons and must not be co-located or operating in conjunction with any other antenna or transmitter."

Federal Communication Commission Interference Statement

This equipment has been tested and found to comply with the limits for a Class B digital device, pursuant to Part 15 of the FCC Rules. These limits are designed to provide reasonable protection against harmful interference in a residential installation. This equipment generates, uses, and can radiate radio frequency energy and, if not installed and used in accordance with the instructions, may cause harmful interference to radio communications. However, there is no guarantee that interference will not occur in a particular installation. If this equipment does cause harmful interference to radio or television reception, which can be determined by turning the equipment off and on, the user is encouraged to try to correct the interference by one of the following measures:

1. Reorient or relocate the receiving antenna.
2. Increase the separation between the equipment and receiver.
3. Connect the equipment into an outlet on a circuit different from that to which the receiver is connected.
4. Consult the dealer or an experienced radio/TV technician for help.

FCC Caution: Any changes or modifications not expressly approved by the party responsible for compliance could void the user's authority to operate this equipment.

This device complies with Part 15 of the FCC Rules. Operation is subject to the following two conditions: (1) This device may not cause harmful interference, and (2) this device must accept any interference received, including interference that may cause undesired operation.

IMPORTANT NOTE: FCC Radiation Exposure Statement:

This equipment complies with FCC radiation exposure limits set forth for an uncontrolled environment. This equipment should be installed and operated with minimum distance 20cm between the radiator & your body.

Labeling Requirements

The final end product must be labeled in a visible area with the following notice:

Contains FCC ID: TWG-SDCPE15N

Industry Canada**User's Guide Requirements**

As outlined in the Operational Description, the SDC-PE15N complies with Industry Canada (IC) rules for a Limited Modular Approval. To leverage Summit's grant, the two conditions below must be met for the host device into which the SDC-PE15N is integrated:

1. The antenna is installed with 20 cm maintained between the antenna and users.
2. The transmitter module is not co-located with any other transmitter or antenna that is capable of simultaneous operation.

As long as the two conditions above are met, further *transmitter* testing is typically not required. However, the OEM integrator is still responsible for testing its end-product for any additional compliance requirements required with this module installed, such as (but not limited to) digital device emissions and PC peripheral requirements.

IMPORTANT!

In the event that the two conditions above *cannot be met* (for example certain device configurations or co-location with another transmitter), then the IC authorization is no longer considered valid and the IC ID *cannot* be used on the final product. In these circumstances, the OEM integrator will be responsible for re-evaluating the end product (including the transmitter) and obtaining a separate IC authorization.

When using Summit's IC grant for the SDC-PE15N, the integrator must include specific information in the user's guide for the device into which the SDC-PE15N is integrated. The integrator must not provide information to the end user regarding how to install or remove this RF module in the user's manual of the device into which the SDC-PE15N is integrated. In addition to the required FCC statements outlined above, the following IC statements must be added in their entirety and without modification into a prominent place in the user's guide for the device into which the SDC-PE15N is integrated:

To prevent radio interference to the licensed service, this device is intended to be operated indoors and away from windows to provide maximum shielding. Equipment (or its transmit antenna) that is installed outdoors is subject to licensing.

The integrator must list out information for each antenna used with the host device into which the SDC-PE15N is integrated. The following examples are based on antennas with which the SDC-PE15N was certified and represent an acceptable format:

Summit SDC-CF22G Antenna

- Form Factor: Chip Antenna on PCB

SDC-PE15N

Hardware Integration Guide

- Type: Dipole
- Maximum 2.4 GHz Gain: 0 dBi

Cisco AIR-ANT 4941

- Form Factor: Whip
- Type: Dipole
- Maximum 2.4 GHz Gain: 2.2 dBi
- Tested and Certified 2.4 GHz Transmit Power: 90% of maximum setting (power must be reduced to 90%)

Radiall Larson Dipole

- Form Factor: Whip
- Type: Dipole
- Maximum 2.4 GHz Gain: 1.6 dBi (not used during testing)
- Maximum 5 GHz Gain: 5 dBi

HUBER+SUHNER

- Form Factor: Whip
- Type: Monopole
- Maximum 2.4 GHz Gain: 3 dBi
- Maximum 5 GHz Gain: 6.5 dBi
- Tested and Certified 2.4 GHz Transmit Power: 95% of maximum setting (power must be reduced to 95%)
- Tested and Certified 5 GHz Transmit Power: 100% of maximum setting (no reduction of power is required in the 5 GHz band)

Labeling Requirements

The final end product must be labeled in a visible area with the following notice:

Contains IC ID: 6616A-SDCPE15N

European Union

User's Guide Requirements

The integrator must include specific information in the user's guide for the device into which the SDC-PE15N is integrated. In addition to the required FCC and IC statements outlined above, the following R&TTE statements must be added in their entirety and without modification into a prominent place in the user's guide for the device into which the SDC-PE15N is integrated:

This device complies with the essential requirements of the R&TTE Directive 1999/5/EC. The following test methods have been applied in order to prove presumption of conformity with the essential requirements of the R&TTE Directive 1999/5/EC:



- EN60950-1:2001 A11:2004
Safety of Information Technology Equipment
- EN 300 328 V1.7.1: (2006-10)
Electromagnetic compatibility and Radio spectrum Matters (ERM); Wideband Transmission systems; Data transmission equipment operating in the 2,4 GHz ISM band and using spread spectrum modulation techniques; Harmonized EN covering essential requirements under article 3.2 of the R&TTE Directive
- EN 301 489-1 V1.6.1: (2005-09)
Electromagnetic compatibility and Radio Spectrum Matters (ERM); ElectroMagnetic Compatibility (EMC) standard for radio equipment and services; Part 1: Common technical requirements.
- EN 301 489-17 V1.2.1 (2002-08)
Electromagnetic compatibility and Radio spectrum Matters (ERM); ElectroMagnetic Compatibility (EMC) standard for radio equipment and services; Part 17: Specific conditions for 2,4 GHz wideband transmission systems and 5 GHz high performance RLAN equipment
- EN 301 893 V1.5.1 (2008-12)
Electromagnetic compatibility and Radio spectrum Matters (ERM); Broadband Radio Access Networks (BRAN); Specific conditions for 5 GHz high performance RLAN equipment
- EU 2002/95/EC (RoHS)













Declaration of Compliance – EU Directive 2003/95/EC; Reduction of Hazardous Substances (RoHS)



This device is a 2.4 GHz wideband transmission system (transceiver), intended for use in all EU member states and EFTA countries, except in France and Italy where restrictive use applies.

In Italy the end-user should apply for a license at the national spectrum authorities in order to obtain authorization to use the device for setting up outdoor radio links and/or for supplying public access to telecommunications and/or network services.

This device may not be used for setting up outdoor radio links in France and in some areas the RF output power may be limited to 10 mW EIRP in the frequency range of 2454 – 2483.5 MHz. For detailed information the end-user should contact the national spectrum authority in France.

 Český [Czech]	<i>[Iméno výrobce]</i> tímto prohlašuje, že tento <i>[typ zařízení]</i> je ve shodě se základními požadavky a dalšími příslušnými ustanoveními směrnice 1999/5/ES.
 Dansk [Danish]	Undertegnede <i>[fabrikantens navn]</i> erklærer herved, at følgende udstyr <i>[udstyrets typebetegnelse]</i> overholder de væsentlige krav og øvrige relevante krav i direktiv 1999/5/EF.
 Deutsch [German]	Hiermit erkläre <i>[Name des Herstellers]</i> , dass sich das Gerät <i>[Gerätetyp]</i> in Übereinstimmung mit den grundlegenden Anforderungen und den übrigen

	einschlägigen Bestimmungen der Richtlinie 1999/5/EG befindet.
 Eesti [Estonian]	Käesolevaga kinnitab [<i>tootja nimi = name of manufacturer</i>] seadme [<i>seadme tüüp = type of equipment</i>] vastavust direktiivi 1999/5/EÜ põhinõuetele ja nimetatud direktiivist tulenevatele teistele asjakohastele sätetele.
 English	Hereby, [<i>name of manufacturer</i>], declares that this [<i>type of equipment</i>] is in compliance with the essential requirements and other relevant provisions of Directive 1999/5/EC.
 Español [Spanish]	Por medio de la presente [<i>nombre del fabricante</i>] declara que el [<i>clase de equipo</i>] cumple con los requisitos esenciales y cualesquiera otras disposiciones aplicables o exigibles de la Directiva 1999/5/CE.
 Ελληνική [Greek]	ΜΕ ΤΗΝ ΠΑΡΟΥΣΑ [<i>name of manufacturer</i>] ΔΗΛΩΝΕΙ ΟΤΙ [<i>type of equipment</i>] ΣΥΜΜΟΡΦΩΝΕΤΑΙ ΠΡΟΣ ΤΙΣ ΟΥΣΙΩΔΕΙΣ ΑΠΑΙΤΗΣΕΙΣ ΚΑΙ ΤΙΣ ΛΟΙΠΕΣ ΣΧΕΤΙΚΕΣ ΔΙΑΤΑΞΕΙΣ ΤΗΣ ΟΔΗΓΙΑΣ 1999/5/ΕΚ.
 Français [French]	Par la présente [<i>nom du fabricant</i>] déclare que l'appareil [<i>type d'appareil</i>] est conforme aux exigences essentielles et aux autres dispositions pertinentes de la directive 1999/5/CE.
 Italiano [Italian]	Con la presente [<i>nome del costruttore</i>] dichiara che questo [<i>tipo di apparecchio</i>] è conforme ai requisiti essenziali ed alle altre disposizioni pertinenti stabilite dalla direttiva 1999/5/CE.
Latviski [Latvian]	Ar šo [<i>name of manufacturer / izgatavotāja nosaukums</i>] deklarē, ka [<i>type of equipment / iekārtas tips</i>] atbilst Direktīvas 1999/5/EK būtiskajām prasībām un citiem ar to saistītajiem noteikumiem.
Lietuvių [Lithuanian]	Šiuo [<i>manufacturer name</i>] deklaruoja, kad šis [<i>equipment type</i>] atitinka esminius reikalavimus ir kitas 1999/5/EB Direktyvos nuostatas.
 Nederlands [Dutch]	Hierbij verklaart [<i>naam van de fabrikant</i>] dat het toestel [<i>type van toestel</i>] in overeenstemming is met de essentiële eisen en de andere relevante bepalingen van richtlijn 1999/5/EG.
 Malti [Maltese]	Hawnhekk, [<i>isem tal-manifattur</i>], jiddikjara li dan [<i>il-mudel tal-prodott</i>] jikkonforma mal-ħtiġijiet essenzjali u ma provvedimenti oħrajn relevanti li hemm fid-Dirrettiva 1999/5/EC.
 Magyar [Hungarian]	Alulírott, [<i>gyártó neve</i>] nyilatkozom, hogy a [<i>... típus</i>] megfelel a vonatkozó alapvető követelményeknek és az 1999/5/EC irányelv egyéb előírásainak.
 Polski [Polish]	Niniejszym [<i>nazwa producenta</i>] oświadczam, że [<i>nazwa wyrobu</i>] jest zgodny z zasadniczymi wymogami oraz pozostałymi stosownymi postanowieniami Dyrektywy 1999/5/EC.
 Português [Portuguese]	[<i>Nome do fabricante</i>] declara que este [<i>tipo de equipamento</i>] está conforme com os requisitos essenciais e outras disposições da Directiva 1999/5/CE.
 Slovensko	[<i>Ime proizvajalca</i>] izjavlja, da je ta [<i>tip opreme</i>] v skladu z bistvenimi zahtevami in

[Slovenian]	ostalimi relevantnimi določili direktive 1999/5/ES.
Slovensky [Slovak]	<i>[Meno výrobcu]</i> týmto vyhlasuje, že <i>[typ zariadenia]</i> spĺňa základné požiadavky a všetky príslušné ustanovenia Smernice 1999/5/ES.
 Suomi [Finnish]	<i>[Valmistaja = manufacturer]</i> vakuuttaa täten että <i>[type of equipment = laitteen tyyppimerkintä]</i> tyyppinen laite on direktiivin 1999/5/EY oleellisten vaatimusten ja sitä koskevien direktiivin muiden ehtojen mukainen.
 Svenska [Swedish]	Härmed intygar <i>[företag]</i> att denna <i>[utrustningstyp]</i> står i överensstämmelse med de väsentliga egenskapskrav och övriga relevanta bestämmelser som framgår av direktiv 1999/5/EG.

Labeling Requirements

The final end product must be labeled in a visible area with the following notice:

