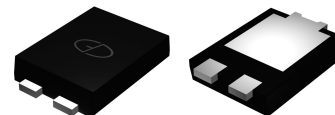
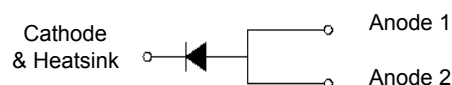


## Features

- Heatsink design
- Schottky barrier diodes
- Low forward voltage drop
- Low leakage current
- Moisture sensitivity: level 1, per J-STD-020
- Solder dip 260 °C, 10 s
- Low profile - typical height of 1.1 mm
- High temperature soldering guaranteed: 260°C/10 seconds



Package:  
eSGC (TO-277)



Schematic Diagram

## Applications

- Low voltage high frequency inverters
- DC/DC converters
- Polarity protection applications

## Absolute Maximum Ratings (T<sub>A</sub>=25°C unless otherwise noted)

Parameter	Symbol	Value	Unit
Peak Repetitive Peak Reverse Voltage	V <sub>RRM</sub>	200	V
Maximum RMS Voltage	V <sub>RMS</sub>	140	V
DC Blocking Voltage	V <sub>DC</sub>	200	V
Maximum Average Forward Rectified Current	I <sub>F(AV)</sub>	10.0	A
Peak Forward Surge Current 8.3 ms Single Half Sine-Wave Superimposed on Rated Load	I <sub>FSM</sub>	175	A
Operating Junction and Storage Temperature Range	T <sub>J</sub> , T <sub>STG</sub>	-55 to +150	°C

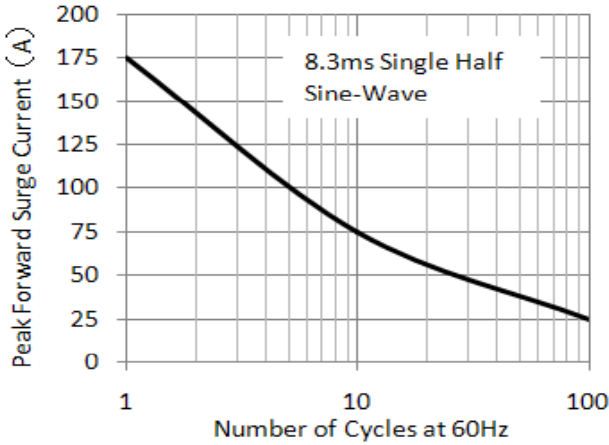
## Electrical Characteristics (T<sub>A</sub>=25°C unless otherwise noted)

Parameter	Test Conditions		Symbol	MAX.	Unit
Maximum Instantaneous Forward Voltage	I <sub>F</sub> =10A	T <sub>A</sub> =25°C	V <sub>F</sub>	0.85	V
Maximum instantaneous Reverse Current	V <sub>R</sub> =200V	T <sub>A</sub> =25°C	I <sub>R</sub>	50	uA
		T <sub>A</sub> =125°C		20	mA
Typical Junction Capacitance	4.0 V, 1 MHz		C <sub>J</sub>	206	pF
Typical Thermal Resistance	Junction to Mount		R <sub>θJM</sub> <sup>1</sup>	5	°C/W

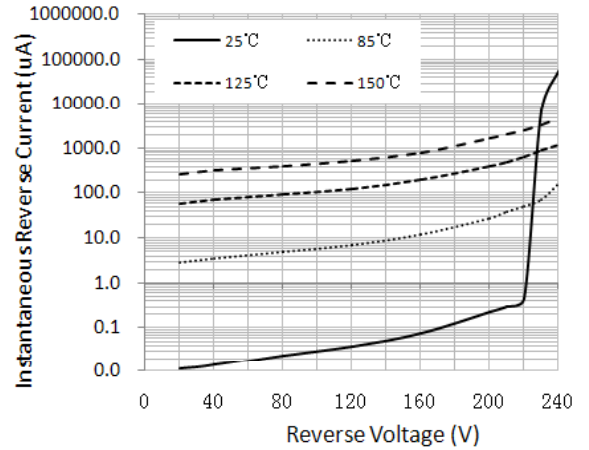
**Notes:**

1) Thermal resistance R<sub>θJM</sub> is junction to mount, mounted on P.C.B with 30\*30mm copper pad area

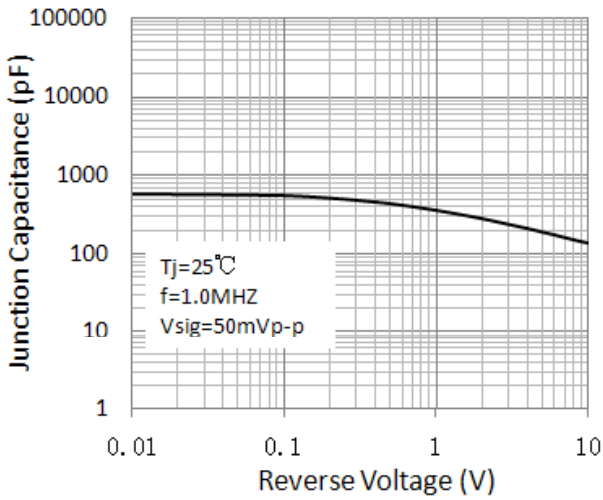
**Typical Characteristics Curves**



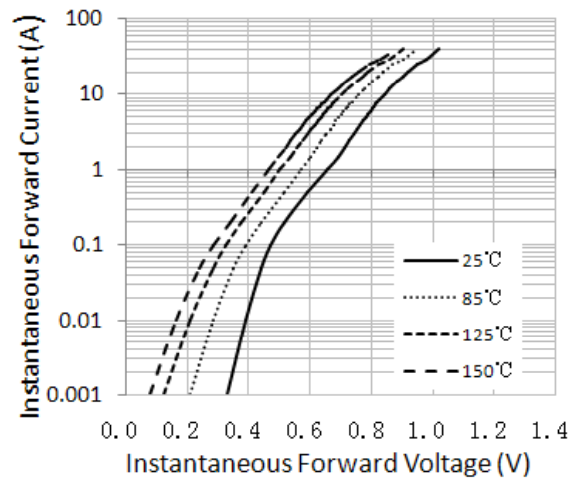
**Figure 1. Maximum Non-Repetitive Peak Forward Surge Current**



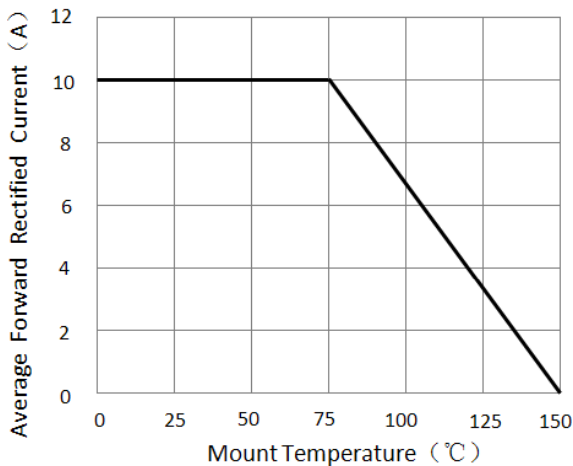
**Figure 2. Typical Reverse Characteristics**



**Figure 3. Typical Junction Capacitance**

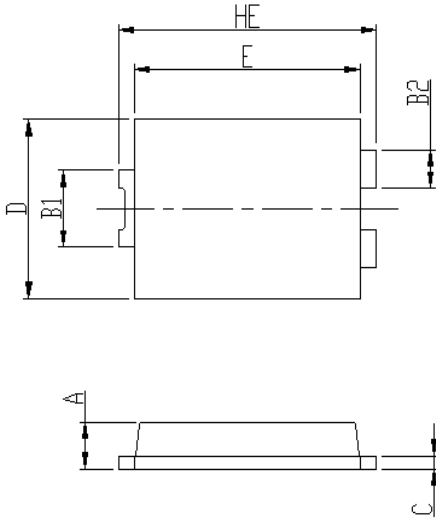


**Figure 4. Typical Instantaneous Forward Characteristics**

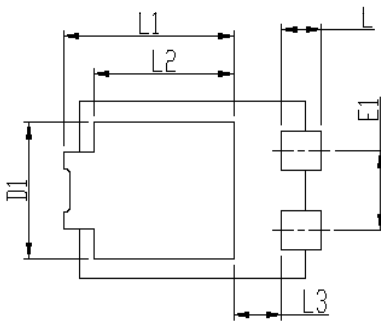


**Figure 5. Forward Current Derating Curve**

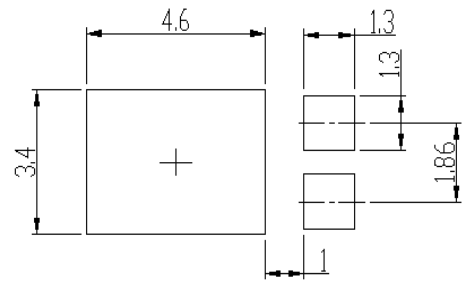
## Package Outline Dimensions eSGC (TO-277)



DIM	Unit: mm		Unit: inch	
	MIN	MAX	MIN	MAX
HE	6.4	6.6	0.252	0.260
E	5.6	5.8	0.220	0.228
D	4.1	4.3	0.161	0.169
B1	1.7	1.9	0.067	0.075
B2	0.8	1	0.031	0.039
A	1.05	1.2	0.041	0.047
C	0.3	0.4	0.012	0.016
L	0.85	1.1	0.033	0.043
L1	4.2	4.4	0.165	0.173
L2	3.52 Typ.		0.139 Typ.	
L3	1.1	1.4	0.043	0.055
D1	3	3.3	0.118	0.130
E1	1.86 Typ.		0.073 Typ.	



Soldering footprint



## Suggested Pad Layout

