

THE INFORMATION CONTAINED IN THIS DRAWING IS THE SOLE PROPERTY OF BUD INDUSTRIES INC. ANY REPRODUCTION IN PART OR WHOLE WITHOUT THE WRITTEN PERMISSION OF BUD INDUSTRIES INC. IS PROHIBITED.

DWG. NO.	CN-5707
ISSUE	REVISIONS

MATERIAL - ALUMINUM ALLOY #ADC-12  
 FINISH - NATURAL (CONTACT BUD FACTORY FOR ALTERNATE FINISHES)  
 GASKET - RATED IP65 NEOPRENE, SELF-ADHESIVE, 3mm THICK, COLOR BLACK  
 SCREWS - STAINLESS STEEL, M3.5 x 12mm LG., CSK. HEAD, SELF-THREADING

ALL HOLE DIAMETERS HAVE ±.005 TOLERANCE.  
 ALL OTHER DIMENSIONS HAVE ±.015 TOLERANCE.  
 ENCLOSURES ARE SHIPPED UNASSEMBLED WITH ALL ITEMS SHOWN.

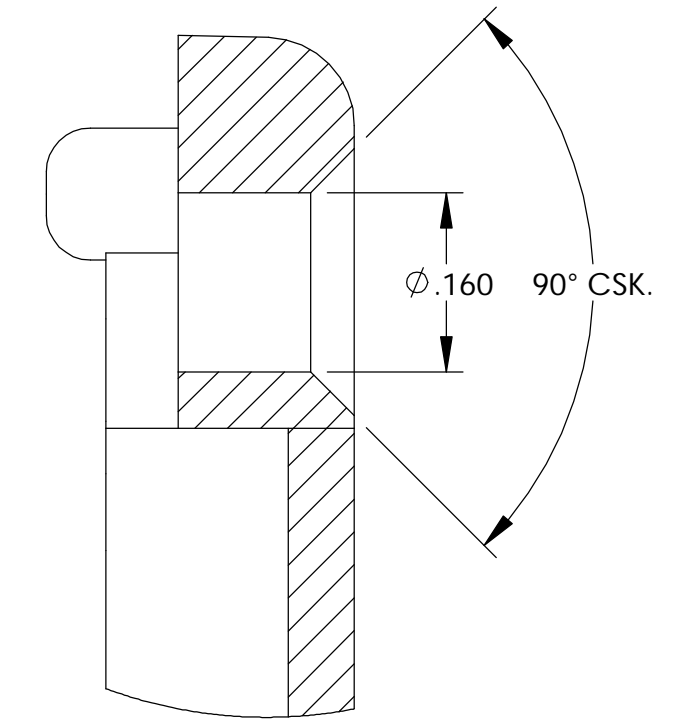
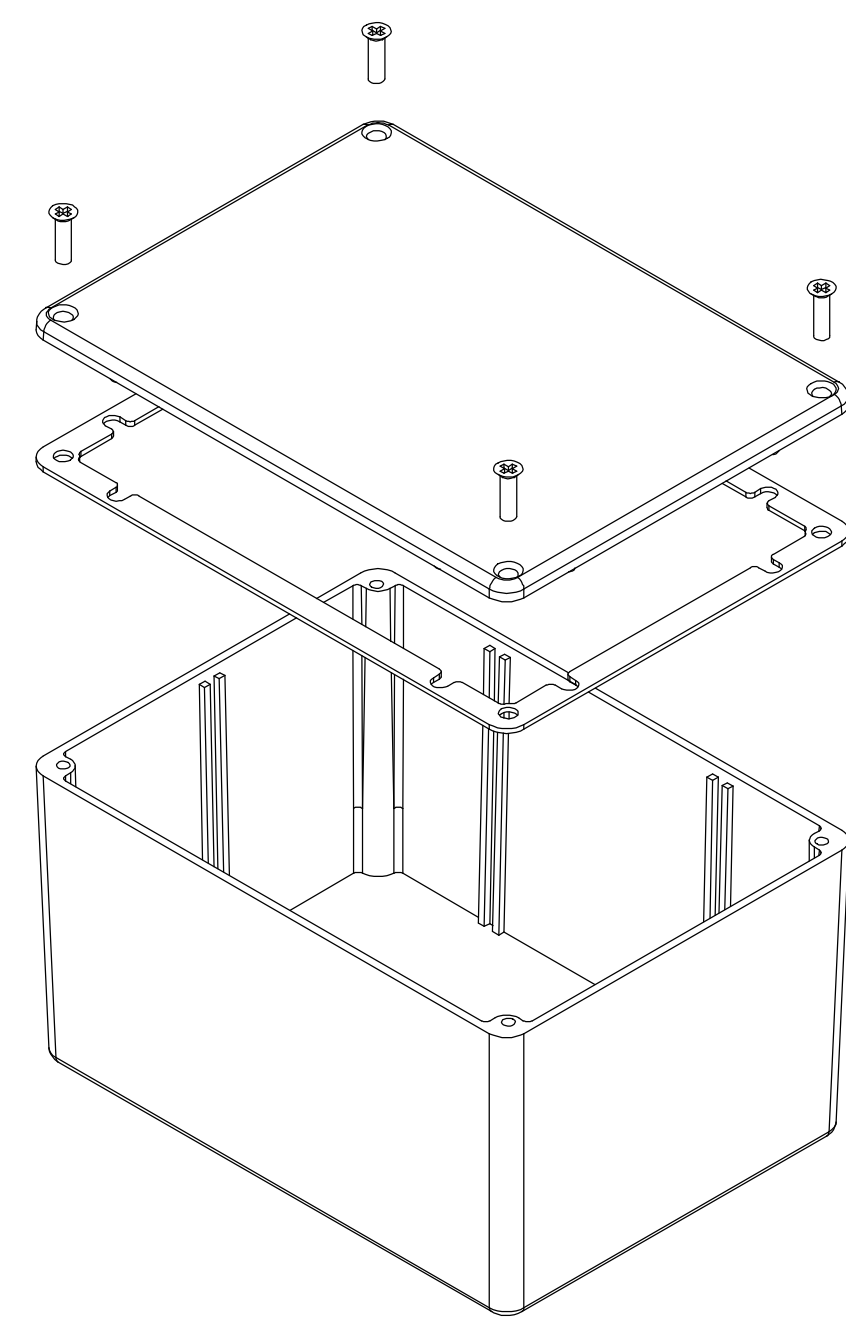

DETAIL D  
SCALE 6 : 1

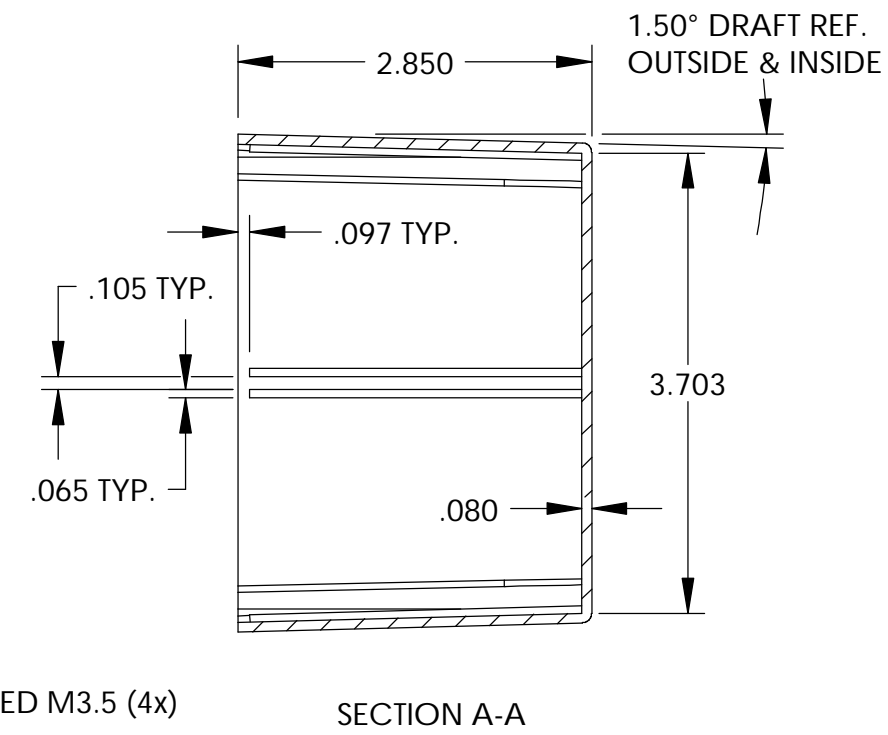
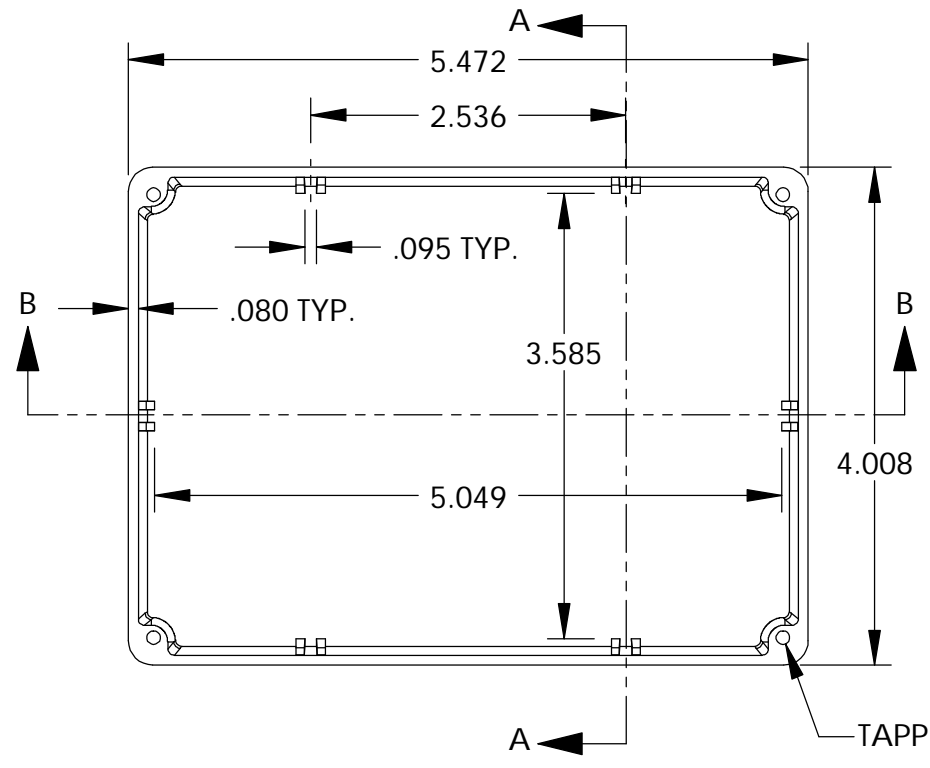

BODY

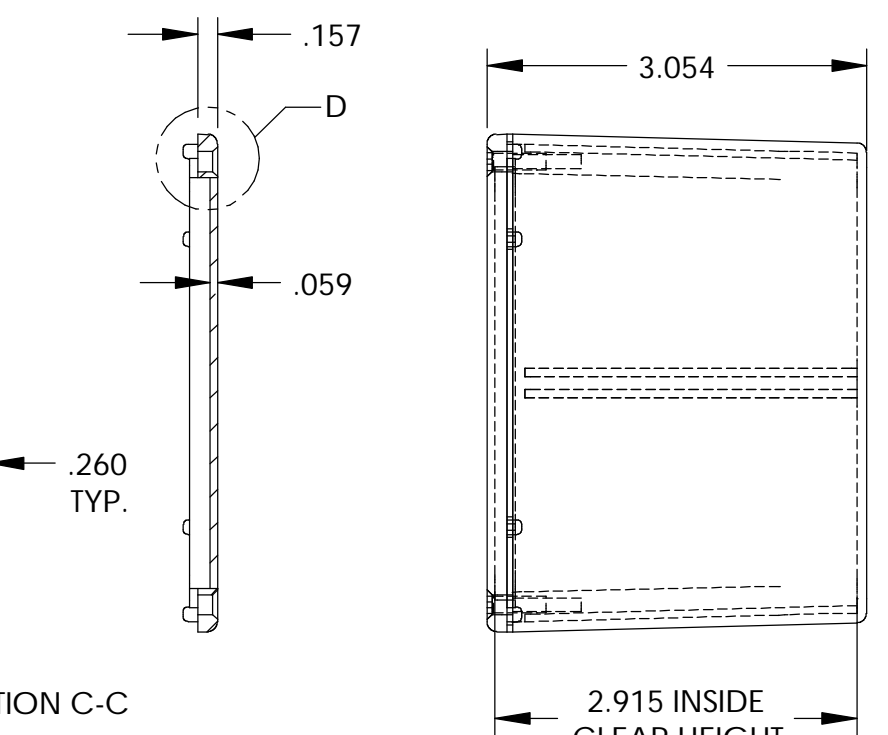
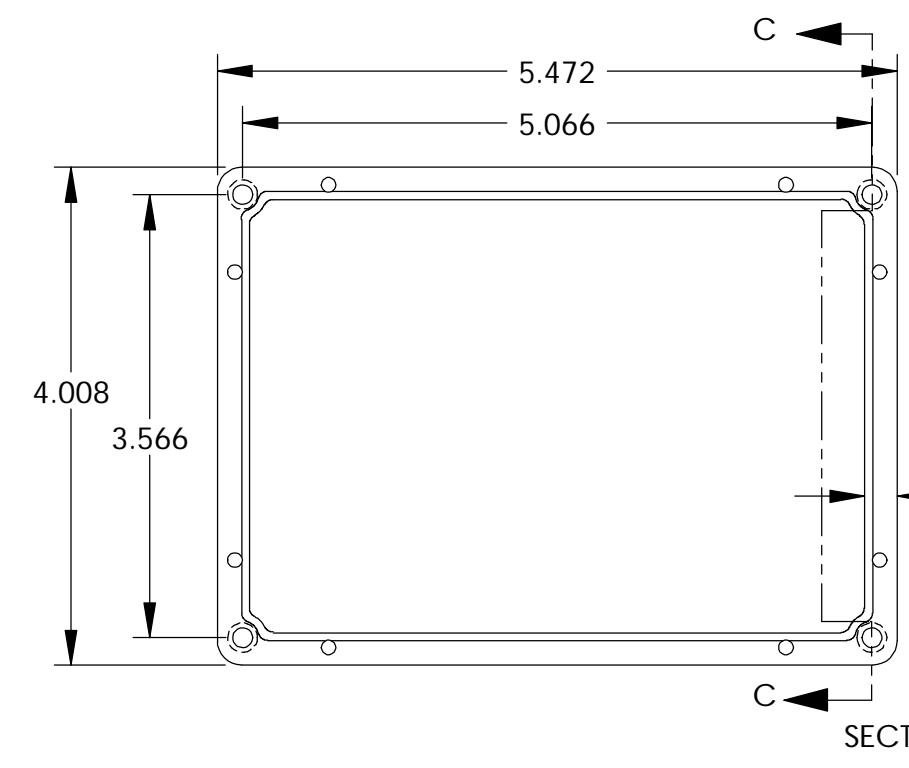

COVER

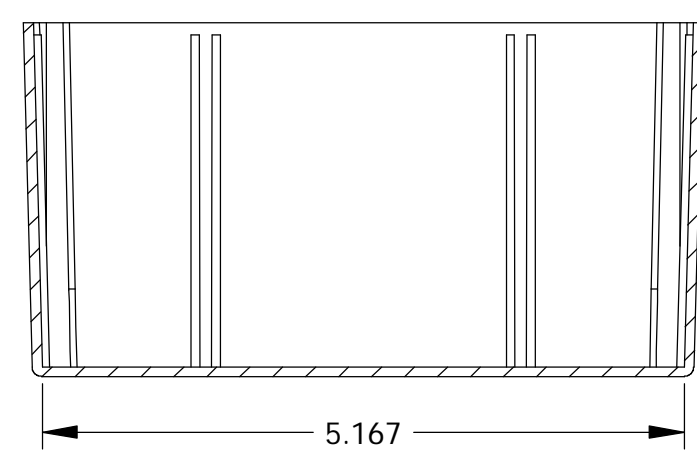

SECTION B-B

PARTS LIST		BUD INDUSTRIES INC.	
+/- .005 BETWEEN HOLE CENTERS +/- .015 FROM SHEARED EDGE +/- .032 FROM A BENT SURFACE +/- .062 BETWEEN ASSEMBLED SURFACES UNLESS OTHERWISE SPECIFIED		CAD GENERATED DRAWING. DO NOT MANUALLY UPDATE	
MATERIAL		APPROVALS	DATE
FINISH		DRAWN	3-31-06
AS NOTED		CHECKED	
AS NOTED		APPROVED	
QTY.	USED ON	SCALE	DWG. NO. CN-5707
		DO NOT SCALE DRAWING	REV.
			CAD FILE: SHEET 1 OF 1