

STRADA-SQ-FS3

Forward throw beam optimized for European tunnels, resulting in extremely efficient lighting with counter-beam method. Version with location pins. Assembly with installation tape.

TECHNICAL SPECIFICATIONS:

| | |
|----------------|----------------|
| Dimensions | 25.0 x 25.0 mm |
| Height | 16.2 mm |
| Fastening | tape |
| ROHS compliant | yes ⓘ |



MATERIAL SPECIFICATIONS:

| Component | Type | Material | Colour | Finish |
|---------------|-------------|----------|--------|--------|
| STRADA-SQ-FS3 | Single lens | PMMA | clear | |
| ROSE-TAPE | Tape | PU tape | black | |

ORDERING INFORMATION:

| Component | Type | Qty in box | MOQ | MPQ | Box weight (kg) |
|--------------------------------|-------------|------------|-----|-----|-----------------|
| CA15226_STRADA-SQ-FS3 | Single lens | 1470 | 294 | 98 | 7.4 |
| » Box size: 480 x 280 x 300 mm | | | | | |

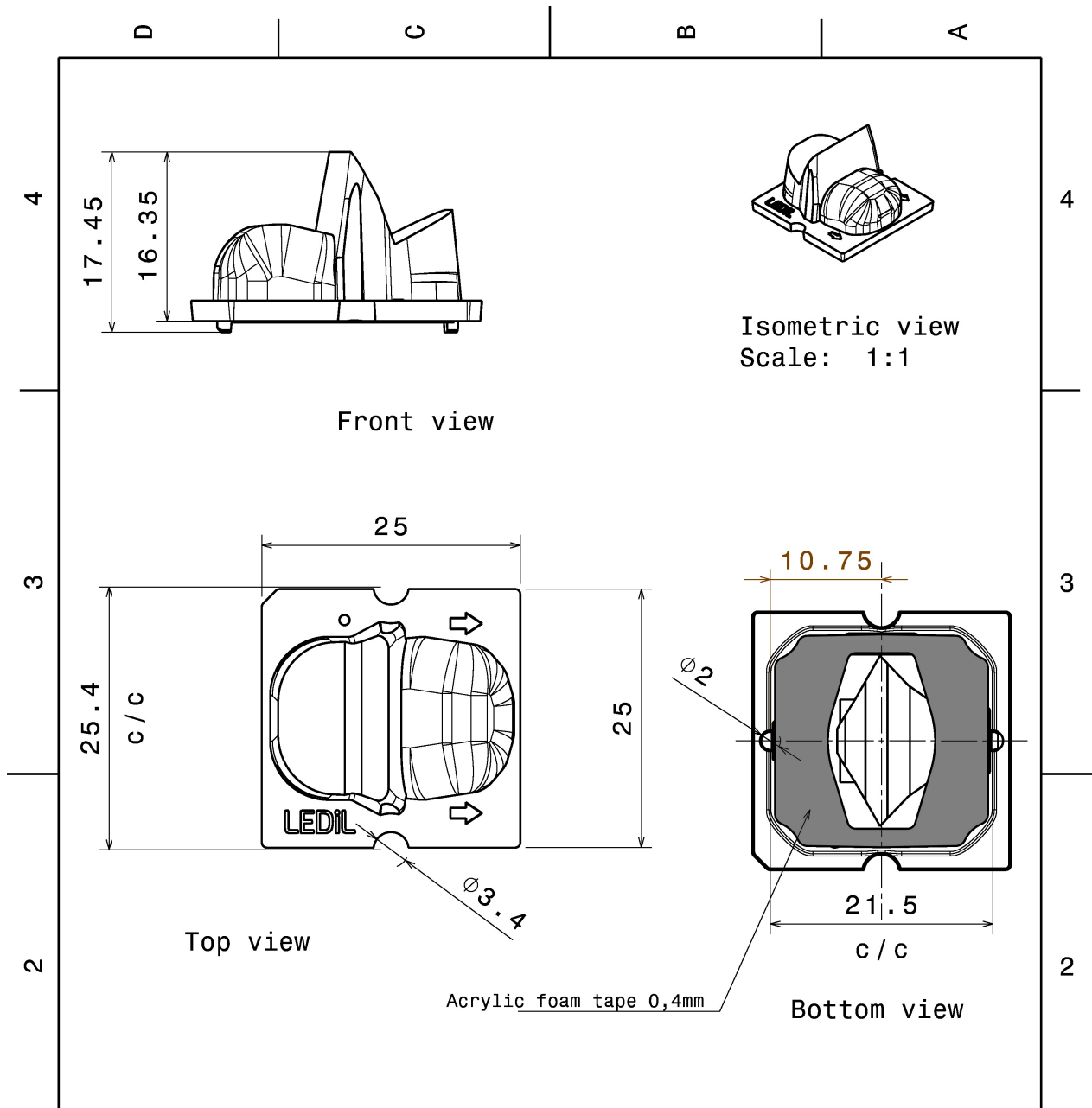

| INDEX | PART NO | DESCRIPTION | MATERIAL | COLOUR |
|---|---------|--|----------|------------------|
| 1 | C15109 | STRADA-SQ-FS3 | PMMA | |
| <p>Tolerances if not otherwise shown According to DIN ISO 2768-1 Linear measures: Up to 30mm class M, otherwise class C. According to DIN ISO 2768-2 Form and position: class L</p> | | <p>LEDiL Ledil Oy Salorankatu 10 FIN 24240 SALO Finland</p> | | |
| <p>THIRD ANGLE PROJECTION: </p> | | <p>DRAWING TITLE CA15226_STRADA-SQ-FS3</p> | | |
| <p>This drawing is the property of LEDiL Oy. It may not be reproduced, copied or communicated without a written agreement with LEDiL Oy.</p> | | <p>SIZE PART NUMBER A4 CA15226</p> | | |
| <p>SCALE 2:1</p> | | <p>WEIGHT 3,51 g</p> | | <p>SHEET 1/1</p> |

See also our general installation guide: www.ledil.com/installation_guide

PHOTOMETRIC DATA (MEASURED):



LED MK-R
 FWHM / FWTM 125.0° / 157.0°
 Efficiency 88 %
 Peak intensity 1.3 cd/lm
 LEDs/each optic 1
 Light colour White
 Required components:

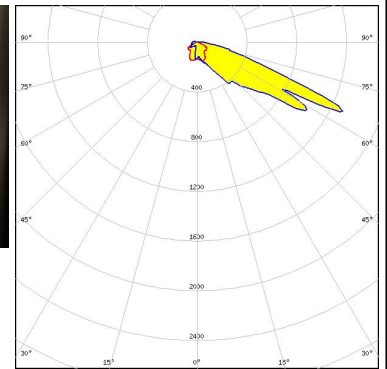

LED LUXEON M/MX
 FWHM / FWTM Asymmetric
 Efficiency 90 %
 Peak intensity 1.2 cd/lm
 LEDs/each optic 1
 Light colour White
 Required components:

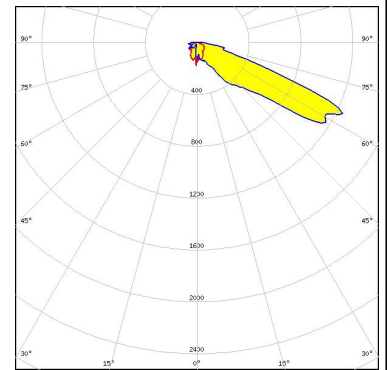

LED LUXEON MZ
 FWHM / FWTM Asymmetric
 Efficiency 91 %
 Peak intensity 2.4 cd/lm
 LEDs/each optic 1
 Light colour White
 Required components:

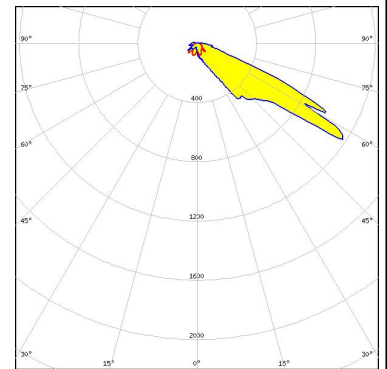

LED NV4x144A
 FWHM / FWTM Asymmetric
 Efficiency 78 %
 Peak intensity 1.2 cd/lm
 LEDs/each optic 1
 Light colour White
 Required components:

Protective plate, glass

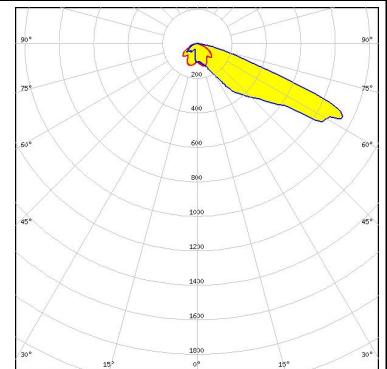

PHOTOMETRIC DATA (MEASURED):

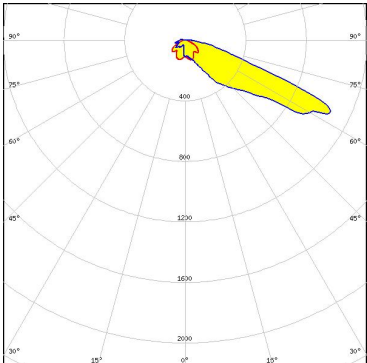
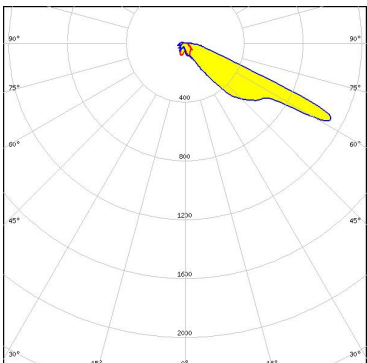
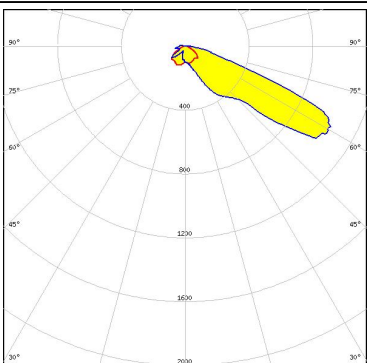
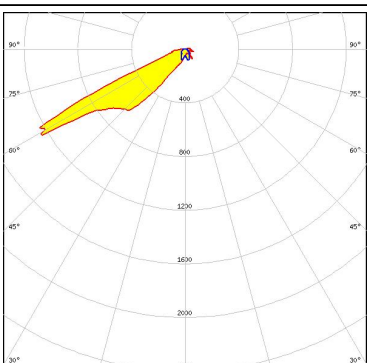
| | |
|--|---|
| <p>NICHIA</p> <p>LED NV4x144A FWHM / FWTM Asymmetric Efficiency 91 % Peak intensity 1.3 cd/lm LEDs/each optic 1 Light colour White Required components:</p> |  |
| <p>NICHIA</p> <p>LED NVSW319B FWHM / FWTM Asymmetric Efficiency 90 % Peak intensity 2.4 cd/lm LEDs/each optic 1 Light colour White Required components:</p> |  |
| <p>OSRAM <small>Opto Semiconductors</small></p> <p>LED Duris S10 FWHM / FWTM Asymmetric Efficiency 86 % Peak intensity 1.1 cd/lm LEDs/each optic 1 Light colour White Required components:</p> |  |
| <p>OSRAM <small>Opto Semiconductors</small></p> <p>LED OSLOM Square PC FWHM / FWTM Asymmetric Efficiency 91 % Peak intensity 3.1 cd/lm LEDs/each optic 1 Light colour White Required components:</p> |  |

PHOTOMETRIC DATA (SIMULATED):



LED XHP50.2
 FWHM / FWTM Asymmetric
 Efficiency 90 %
 Peak intensity 1.2 cd/lm
 LEDs/each optic 1
 Light colour White
 Required components:

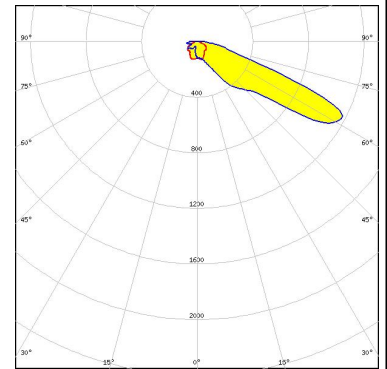

LED XHP50.2
 FWHM / FWTM Asymmetric
 Efficiency 80 %
 Peak intensity 1.1 cd/lm
 LEDs/each optic 1
 Light colour White
 Required components:

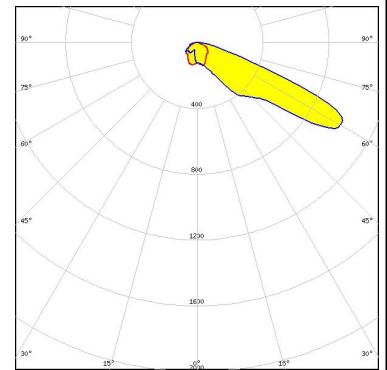

Protective plate, glass



LED XHP70
 FWHM / FWTM Asymmetric
 Efficiency 77 %
 Peak intensity 0.9 cd/lm
 LEDs/each optic 1
 Light colour White
 Required components:

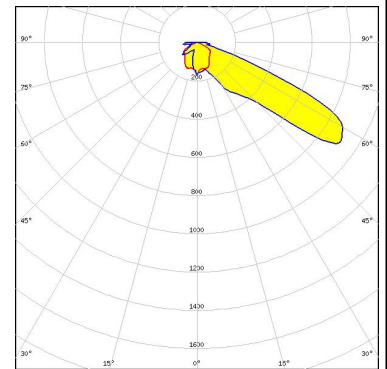

Protective plate, glass



LED XM-L2
 FWHM / FWTM Asymmetric
 Efficiency 88 %
 Peak intensity 2 cd/lm
 LEDs/each optic 1
 Light colour White
 Required components:

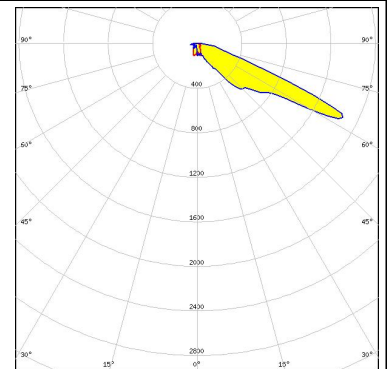

PHOTOMETRIC DATA (SIMULATED):



LED XP-G3
 FWHM / FWTM Asymmetric
 Efficiency 86 %
 Peak intensity 1.8 cd/lm
 LEDs/each optic 1
 Light colour Red
 Required components:

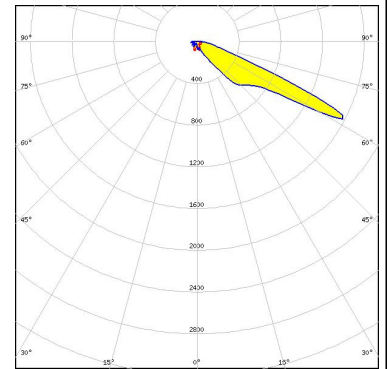

LED XP-G3
 FWHM / FWTM Asymmetric
 Efficiency 90 %
 Peak intensity 1.7 cd/lm
 LEDs/each optic 1
 Light colour White
 Required components:

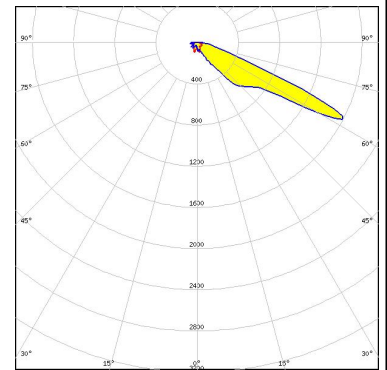

LED XT-E
 FWHM / FWTM Asymmetric
 Efficiency 87 %
 Peak intensity 2.5 cd/lm
 LEDs/each optic 1
 Light colour White
 Required components:

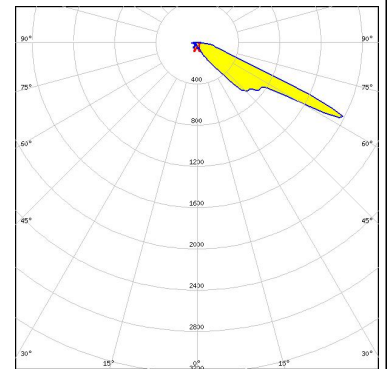

LED LUXEON 5050 Round LES
 FWHM / FWTM Asymmetric
 Efficiency 88 %
 Peak intensity 1.5 cd/lm
 LEDs/each optic 1
 Light colour White
 Required components:

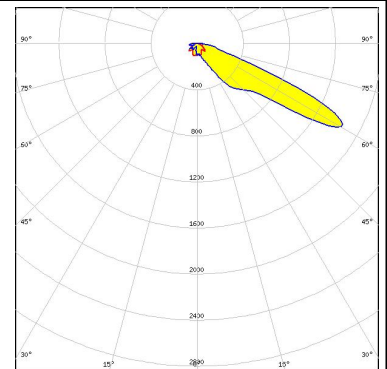

PHOTOMETRIC DATA (SIMULATED):

| | |
|--|--|
| <p>LUMILEDS</p> <p>LED: LUXEON 5050 Square LES</p> <p>FWHM / FWTM: Asymmetric</p> <p>Efficiency: 86 %</p> <p>Peak intensity: 1.5 cd/lm</p> <p>LEDs/each optic: 1</p> <p>Light colour: White</p> <p>Required components:</p> | |
| <p>LUMILEDS</p> <p>LED: LUXEON MMX</p> <p>FWHM / FWTM: Asymmetric</p> <p>Efficiency: 76 %</p> <p>Peak intensity: 1 cd/lm</p> <p>LEDs/each optic: 1</p> <p>Light colour: White</p> <p>Required components:</p> <p style="background-color: #ADD8E6; padding: 2px;">Protective plate, glass</p> | |
| <p>NICHIA</p> <p>LED: NVSxE21A</p> <p>FWHM / FWTM: Asymmetric</p> <p>Efficiency: 89 %</p> <p>Peak intensity: 2.1 cd/lm</p> <p>LEDs/each optic: 1</p> <p>Light colour: White</p> <p>Required components:</p> | |
| <p>NICHIA</p> <p>LED: NVSxx19B/NVSxx19C</p> <p>FWHM / FWTM: Asymmetric</p> <p>Efficiency: 90 %</p> <p>Peak intensity: 2.2 cd/lm</p> <p>LEDs/each optic: 1</p> <p>Light colour: White</p> <p>Required components:</p> | |

PHOTOMETRIC DATA (SIMULATED):

OSRAM

Opto Semiconductors

LED OSCONIQ P 7070
 FWHM / FWTM Asymmetric
 Efficiency 85 %
 Peak intensity 1.4 cd/lm
 LEDs/each optic 1
 Light colour White
 Required components:

Protective plate, glass

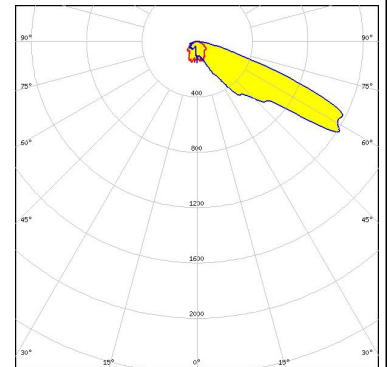

OSRAM

Opto Semiconductors

LED OSCONIQ P 7070
 FWHM / FWTM Asymmetric
 Efficiency 94 %
 Peak intensity 1.4 cd/lm
 LEDs/each optic 1
 Light colour White
 Required components:

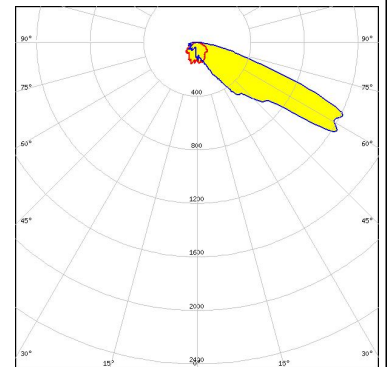

OSRAM

Opto Semiconductors

LED OSLON Square CSSRM2/CSSRM3
 FWHM / FWTM Asymmetric
 Efficiency 90 %
 Peak intensity 2.2 cd/lm
 LEDs/each optic 1
 Light colour White
 Required components:

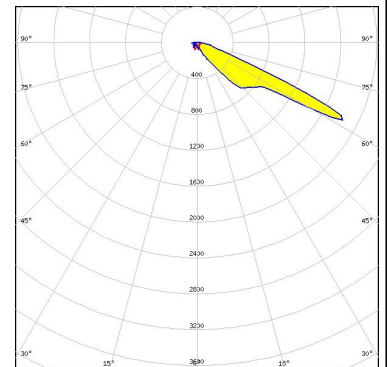

OSRAM

Opto Semiconductors

LED OSLON Square EC
 FWHM / FWTM Asymmetric
 Efficiency 89 %
 Peak intensity 2.1 cd/lm
 LEDs/each optic 1
 Light colour White
 Required components:

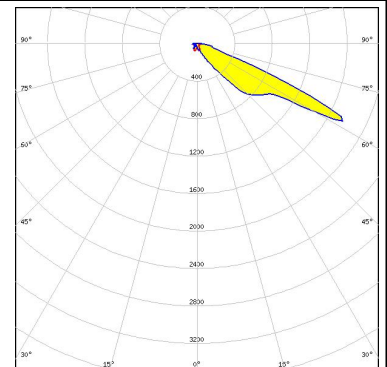

PHOTOMETRIC DATA (SIMULATED):

OSRAM

Opto Semiconductors

LED SFH 4715AS
 FWHM / FWTM Asymmetric
 Efficiency 87 %
 LEDs/each optic 1
 Light colour IR
 Required components:

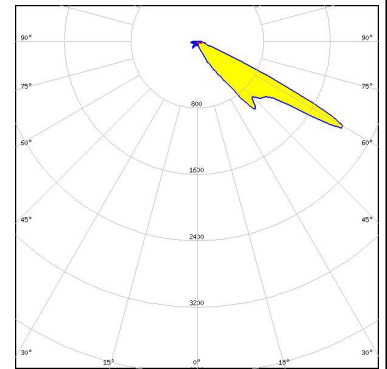

OSRAM

Opto Semiconductors

LED SFH 4716AS
 FWHM / FWTM Asymmetric
 Efficiency 87 %
 LEDs/each optic 1
 Light colour IR
 Required components:

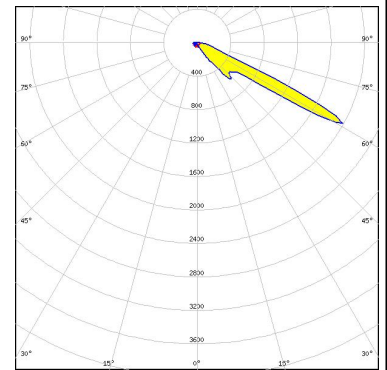

SAMSUNG

LED LH181B
 FWHM / FWTM Asymmetric
 Efficiency 87 %
 Peak intensity 1.2 cd/lm
 LEDs/each optic 4
 Light colour White
 Required components:

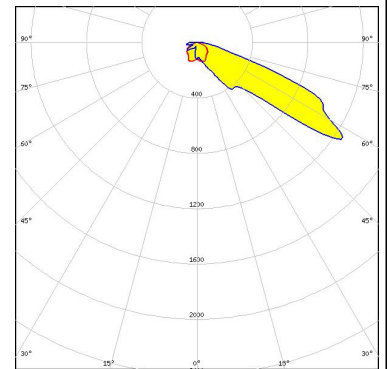

SAMSUNG

LED LH351B
 FWHM / FWTM Asymmetric
 Efficiency 86 %
 Peak intensity 1.4 cd/lm
 LEDs/each optic 1
 Light colour White
 Required components:

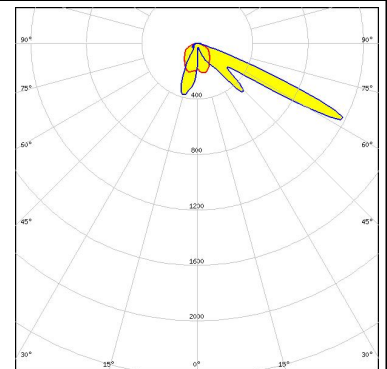

GENERAL INFORMATION:

NOTE: The typical beam angle will be changed by different color, chip size and chip position tolerance. The typical total beam angle is the full angle measured where the luminous intensity is half of the peak value.

MATERIALS:

As part of our continuous research and improvement processes, and to ensure the best possible quality and availability of our products, LEDiL reserves the right to change material grades without notice.

PRODUCT DATA USER AGREEMENT AND DISCLAIMER:

The measured data in the provided downloadable LEDiL Product Datasheets and Mechanical 2D-Drawings is rounded and provided as reference for planning. LEDiL Oy's optical specifications have been verified by conducting performance testing of the products in accordance with the company's quality system. The reported data are averaged results of multiple measurements with typical variation. LEDiL Oy reserves the right to without prior notification make changes and improvements to its products.

LEDiL Oy assumes neither warranty, nor guarantee nor any other liability of any kind for the contents and correctness of the provided data. The provided data has been generated with highest diligence but the provided data may in reality not represent the complete possible variation range of all intrinsic parameters. Therefore, in certain cases a deviation from the provided data could occur.

LEDiL Oy reserves the right to undertake technical changes of its products without further notification which could lead to changes in the provided data. LEDiL Oy assumes no liability of any kind for the possible deviation from any provided data or any other damage resulting from the usage of the provided data.

The user agrees to this disclaimer and user agreement with the download or usage of the provided files.

LEDiL Oy

Joensuunkatu 13
FI-24240 SALO
Finland

LEDiL Inc.

228 West Page Street
Suite D
Sycamore IL 60178
USA

Ledil Optics Technology (Shenzhen) Co., Ltd.

405 , Block B
Casic Motor Building
Shenzhen 518057
P.R.CHINA

Local sales and technical support

[www.ledil.com/
where_to_buy](http://www.ledil.com/where_to_buy)

Shipping locations

Salo, Finland
Hong Kong, China

Distribution Partners

[www.ledil.com/
where_to_buy](http://www.ledil.com/where_to_buy)