

Verpackt im Gurt in Anlehnung an DIN IEC 60286-3
 Tape on Reel Packaging according to DIN IEC 60286-3
 Verpackungseinheit: 600 Stück
 Packaging unit: 600 pcs

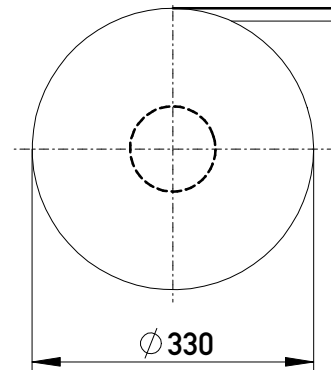

Drahtführung vorverrastet wire guide loose mounted
 Drahtführung verpresst wire guide pressed on

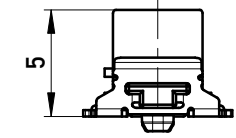
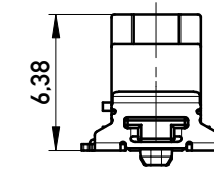

Drahtführungen nicht im Lieferumfang enthalten!
 wire guides are not included in delivery!
 Ident-Nr. für Drahtführungen (für 600 Teile): 244632
 part-no. for wire guides (for 600 parts): 244632

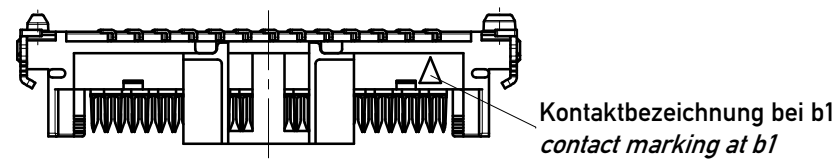
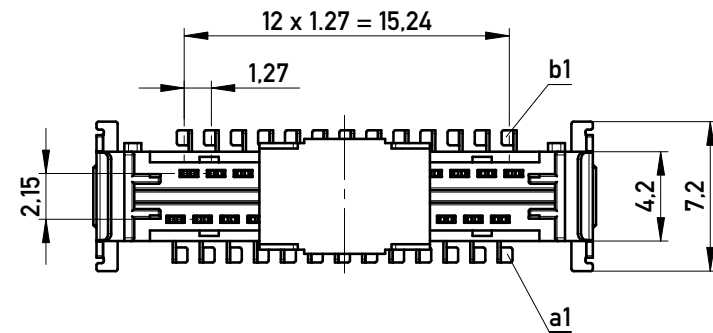

Leiterplatten-LAYOUT Vorschlag für SMT
 PCB-Layout Proposal for SMT

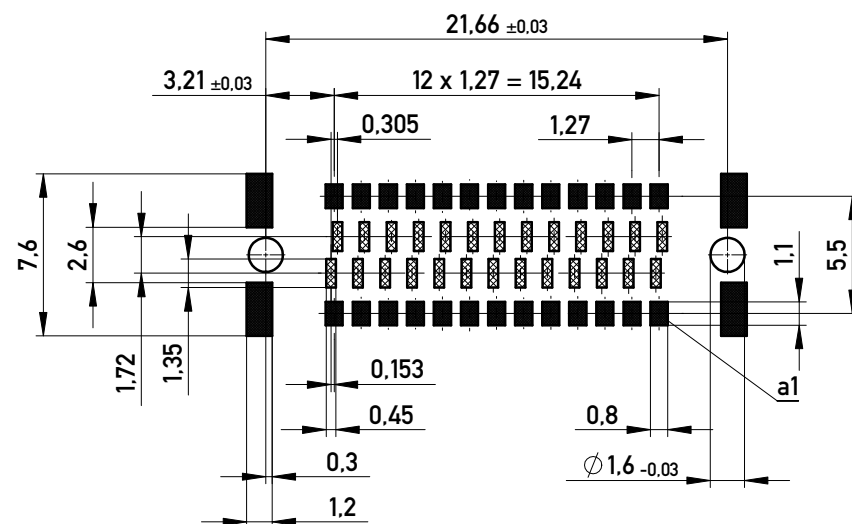

Sperrfläche
 Restricted area

Leiterplatten-LAYOUT Rückseite
 PCB-Layout Back Side

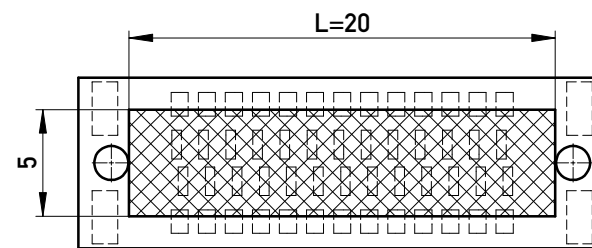

Freifläche Lx 5mm auf der Leiterplatten-Unterseite
 für das Einpresswerkzeug. Keine Bauteile plazieren
 in diesem Bereich.
 PCB back side space Lx5mm
 for press tool. Do not place any
 parts in this space.

Abspulrichtung - Reel off Direction

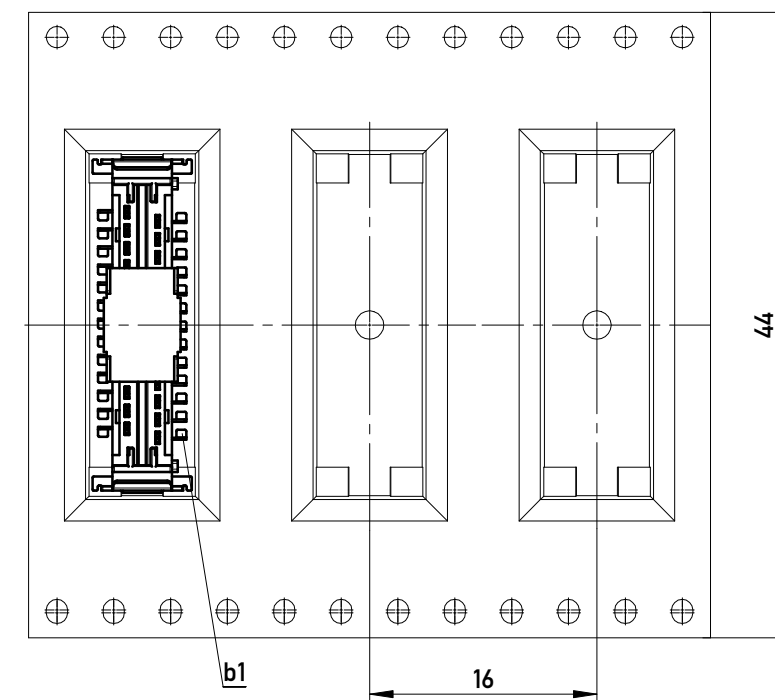

Information:	Tolerances	 All Dimensions in mm	Scale	3:1
	All rights reserved. Only for Information. To ensure that this is the latest version of this drawing, please contact one of the ERNI companies before using.		Designation 1,27 DRC board on IDC 26-polig 26-contacts	
Subject to modification without prior notice. Drawing will not be updated.		 www.ERNI.com	244629	
c	18.01.2017			
Index	Date			I A3
			Class	SMCIDC

Copyright by ERNI Production GmbH & Co. KG
 Proprietary notice pursuant to ISO 16016 to be observed.