



Main

Range of Product	Modicon TM5
Product or Component Type	Dummy module

Complementary

Range Compatibility	Modicon M258 Modicon LMC058
Product Compatibility	Logic controller Motion controller
Marking	CE

Environment

Standards	CSA C22.2 No 213 IEC 61131-2 CSA C22.2 No 142 UL 508
Product Certifications	GOST-R C-tick CSA cULus
Ambient air temperature for operation	14...131 °F (-10...55 °C) without derating horizontal installation) 14...140 °F (-10...60 °C) with derating factor horizontal installation) 14...122 °F (-10...50 °C) vertical installation)
Ambient Air Temperature for Storage	-40...158 °F (-40...70 °C)
Relative Humidity	5...95 % without condensation
IP degree of protection	IP20 IEC 61131-2
Pollution degree	2 IEC 60664
Operating altitude	0...6561.68 ft (0...2000 m)
Storage altitude	0.00...9842.52 ft (0...3000 m)
Vibration resistance	1 gn 8.4...150 Hz DIN rail 3.5 mm 5...8.4 Hz DIN rail
Shock resistance	15 gn 11 ms
Electromagnetic compatibility	Electrostatic discharge immunity test, 4 kV on contact EN/IEC 61000-4-2 Electrostatic discharge immunity test, 8 kV in air EN/IEC 61000-4-2 Susceptibility to electromagnetic fields, 1 V/m 2...2.7 GHz EN/IEC 61000-4-3 Susceptibility to electromagnetic fields, 10 V/m 80...2000 MHz EN/IEC 61000-4-3 Electrical fast transient/burst immunity test, 1 kV I/O EN/IEC 61000-4-4 Electrical fast transient/burst immunity test, 1 kV shielded cable EN/IEC 61000-4-4 Electrical fast transient/burst immunity test, 2 kV power lines EN/IEC 61000-4-4 1.2/50 µs shock waves immunity test, 0.5 kV differential mode EN/IEC 61000-4-5 1.2/50 µs shock waves immunity test, 1 kV common mode EN/IEC 61000-4-5 Conducted RF disturbances EN/IEC 61000-4-6 Conducted and radiated emissions CISPR 11

The information provided in this documentation contains general descriptions and/or technical characteristics of the performance of the products contained herein. This documentation is not intended as a substitute for and is not to be used for determining suitability or reliability of these products for specific user applications. It is the duty of any such user or integrator to perform the appropriate and complete risk analysis, evaluation and testing of the products with respect to the relevant specific application or use thereof. Neither Schneider Electric Industries SAS nor any of its affiliates or subsidiaries shall be responsible or liable for misuse of the information contained herein.

Ordering and shipping details

Category	22532 - M258 PLC
Discount Schedule	PC12
GTIN	3595864074702
Nbr. of units in pkg.	1
Package weight(Lbs)	0.92 oz (26 g)
Returnability	Yes
Country of origin	AT

Packing Units

Unit Type of Package 1	PCE
Package 1 Height	0.79 in (2 cm)
Package 1 width	2.36 in (6 cm)
Package 1 Length	4.17 in (10.6 cm)

Offer Sustainability

Sustainable offer status	Green Premium product
California proposition 65	WARNING: This product can expose you to chemicals including: Lead and lead compounds, which is known to the State of California to cause cancer and birth defects or other reproductive harm. For more information go to www.P65Warnings.ca.gov
REACH Regulation	REACH Declaration
REACH free of SVHC	Yes
EU RoHS Directive	Pro-active compliance (Product out of EU RoHS legal scope) EU RoHS Declaration
Toxic heavy metal free	Yes
Mercury free	Yes
RoHS exemption information	Yes
China RoHS Regulation	China RoHS Declaration
Environmental Disclosure	Product Environmental Profile
Circularity Profile	End Of Life Information
WEEE	The product must be disposed on European Union markets following specific waste collection and never end up in rubbish bins.
PVC free	Yes

Contractual warranty

Warranty	18 months
----------	-----------

TM5 Slice

Dimensions

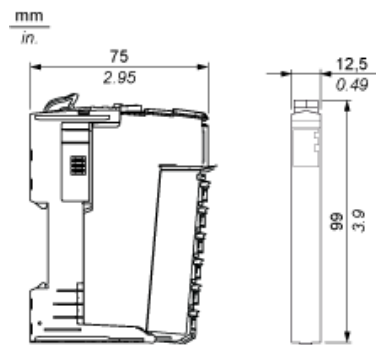

TM5 System

Spacing Requirements

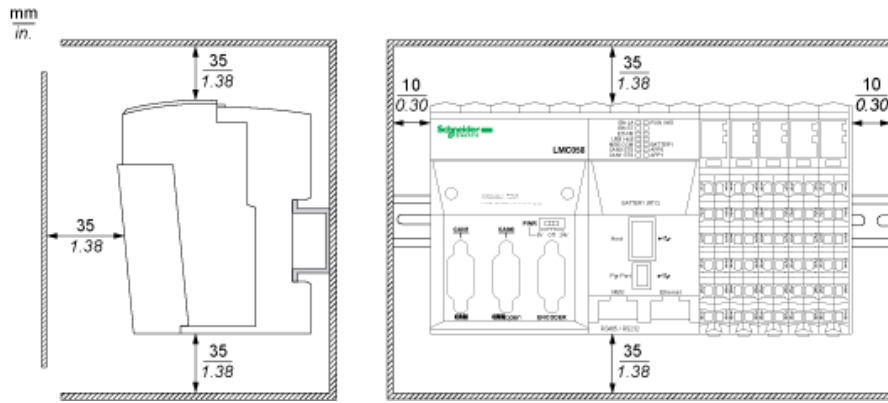



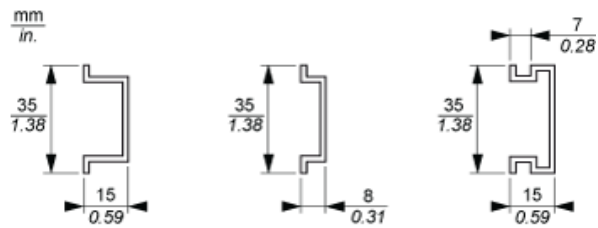

Mounting on a DIN Rail



TM5 System Wiring Recommendations

Wire Sizes to Use with the Removable Spring Terminal Blocks

mm in.				
mm ²	0,08...2,5	0,25...2,5	0,25...1,5	2 x 0,25...2 x 0,75
AWG	28...14	24...14	24...16	2 x 24...2 x 18

Dummy Module

Wiring Diagram

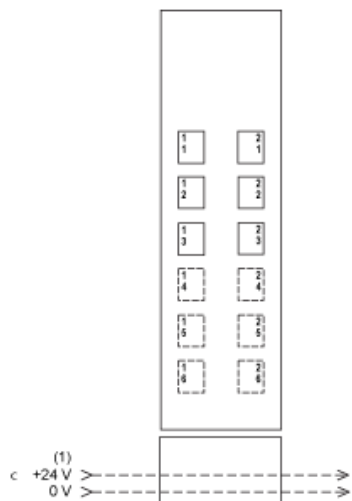

(1) 24 Vdc I/O power segment integrated into the bus bases