

# › GNAD Series

## Essential Solid State Relays

### Panel Mount - DC Output

- › Output current of 10, 20 and 40 Amps
- › Output Voltage of 5-55 V<sub>DC</sub>, 5-100 V<sub>DC</sub> and 5-200 V<sub>DC</sub>
- › Control voltage of 4-32 V<sub>DC</sub>
- › DC switching (DC loads)
- › Integrated IP20 touch-safe removable covers
- › LED input status indicator
- › Cost-effective solution



DC Switching  
Version

Product Selection - DC Switching (DC loads)			
Rated Load Current	10A	20A	40A
Output Voltage	5-200 V <sub>DC</sub>	5-100 V <sub>DC</sub>	5-55 V <sub>DC</sub>
Control Voltage			
4-32 V <sub>DC</sub>	84137650N	84137660N	84137670N

## PART NUMBERING SYSTEM

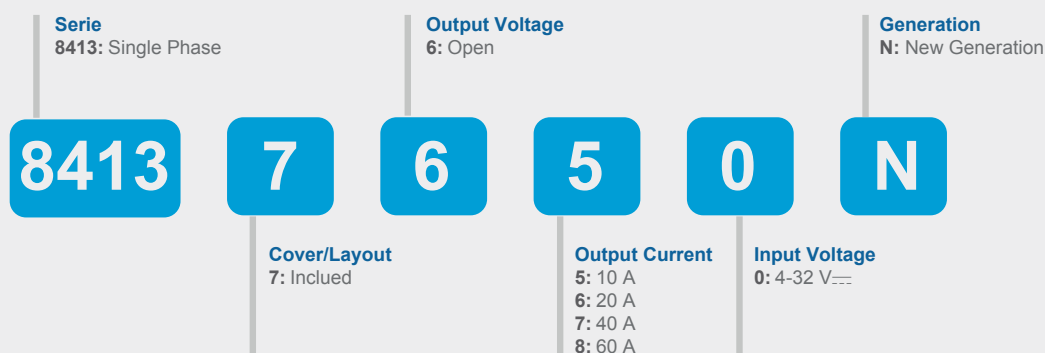

Do you need an adapted or customized solution ? Contact us on [www.crouzet.com](http://www.crouzet.com)

#### Description :

Crouzet Solid State Relays are designed to be used in almost any application, offering very long life expectancy and are easy to install, easy to use, robust and multipurpose.

For more information about Crouzet's Solid State relays, please visit [www.crouzet.com](http://www.crouzet.com).

Accessories		
Type	Description	Part-Number
Heatsink	0,9 °C/W Thermal Resistance	26532752N
Heatsink	1,1 °C/W Thermal Resistance	26532753N
Heatsink	1,2 °C/W Thermal Resistance	26532754N
Heatsink	1,75 °C/W Thermal Resistance	26532755N
Heatsink	2,2 °C/W Thermal Resistance	26532756N
Adapter	DIN Rail	26532764N
Thermal Pad	Self-Adhesive Thermal Pad	26532722N
Screws	Screw Mounting Kit	26532001
Thermal Grease	Thermal Grease for Heatsink mounting	26532003

Output Specifications <sup>(1)</sup>			
Description	10A	20A	40A
Maximum Load Current [Arms] <sup>(3)</sup>	10	20	40
Minimum Load Current [mArms]	5		
Min / Max Operating Voltage [Vrms]	5-200 V <sub>---</sub>	5-100 V <sub>---</sub>	5-55 V <sub>---</sub>
Transient Voltage [Vpk]	200	100	55
Maximum Off-State Leakage Current @ Rated Voltage [mArms]	3		
Minimum Off-State dV/dt @ Maximum Rated Voltage [V/μsec]	N/A		
Non-repetitive peak overload current @ 100 ms [Apeak]	380 @t=0,1ms	187 @t=0,1ms	320 @t=0,1ms
Maximum On-State Voltage Drop @ Rated Current [Vpeak]	0,97	0,98	0,42
Thermal Resistance Junction to Case (Rjc) [°C/W]	0,66	1,4	0,9
Minimum Heat Sink for Rated Current @ 40 °C [°C/W]	3,1	3	3,6

Input Specifications	
Description	4-32 V <sub>---</sub>
Input Voltage Range	4-32 V <sub>---</sub> <sup>(4)</sup>
Maximum Reverse Voltage	-32 V <sub>---</sub>
Minimum Turn-On Voltage	3,5 V <sub>---</sub>
Must Turn-Off Voltage	1 V <sub>---</sub>
Minimum Input Current (for on-state)	34 mA
Maximum Input Current [mA]	35 mA
Nominal Input Impedance [Ohms]	Current Limited
Maximum Turn-On Time [msec]	0,02
Maximum Turn-Off Time [msec]	0,02

General Specifications			
Description	10A	20A	40A
Dielectric Strength, Input/Output to Ground (50/60Hz)	2500 V		
Minimum Insulation Resistance (@ 500 V <sub>---</sub> )	10 <sup>9</sup> Ω		
Maximum Capacitance, Input/Output	8pf		
Ambient Operating Temperature Range	-25 to 90 °C		
Ambient Storage Temperature Range	-40 to 100 °C		
Weight (typical)	80 g		

General Specifications			
Description	10A	20A	40A
Housing Material	UL94 V-0		
Baseplate Material	Aluminium		
Input Terminal Screw Torque Range (in-lb/Nm)	11-18 / 1,2-2,0		
Load Terminal Screw Torque Range (in-lb/Nm)	18-26 / 2-3		
SSR Mounting Screw Torque Range (in-lb/Nm)	11-16 / 1,2-1,8		
Humidity per IEC60068-2-78	40-85 %		
LED Input Status Indicator	Green		
MTBF (Mean Time Between Failures) at 40 °C ambient temperature <sup>(5)</sup>	25		
MTBF (Mean Time Between Failures) at 60 °C ambient temperature <sup>(5)</sup>	17		

General Notes
<sup>(1)</sup> All parameters at 25 °C unless otherwise specified
<sup>(3)</sup> Heat sinking required, see derating curves.
<sup>(4)</sup> Increase minimum voltage by 1 V for operations from -20 to -40 °C.
<sup>(5)</sup> All parameters at 50 % power rating and 100% duty cycle (contact tech support for detailed report).

**Diagrams**  
**Wiring**

GNAD

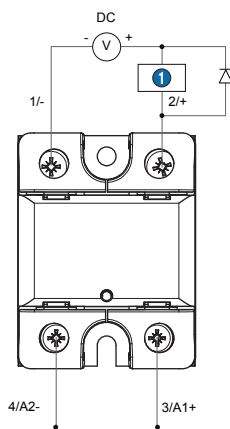

TERMINALS	WIRE SIZE		Terminal Screw Torque (N.m)
	SOLID	STRANDED	
<b>Input</b>	18..14 AWG (0.75..2.5 mm <sup>2</sup> ) 2 x 18..14 AWG (0.75..2.5 mm <sup>2</sup> )	18..14 AWG (0.75..2.5 mm <sup>2</sup> ) 2 x 18..14 AWG (0.75..2.5 mm <sup>2</sup> )	1.2 - 2
<b>Output</b>	16..8 AWG (1.5..10 mm <sup>2</sup> ) 2 x 16..8 AWG (1.5..10 mm <sup>2</sup> )	16..8 AWG (1.5..6 mm <sup>2</sup> ) 2 x 16..10 AWG (1.5..6 mm <sup>2</sup> )	2 - 3

GNAD

1 Load

Diagrams

Equivalent Circuit Block

GNAD Series DC control

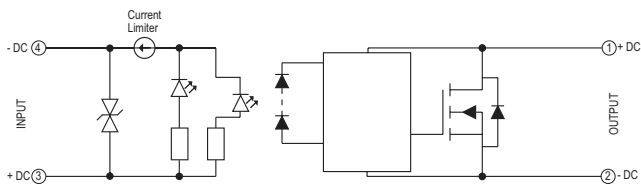

Input current vs Input Voltage  
Standard Regulated DC inputs

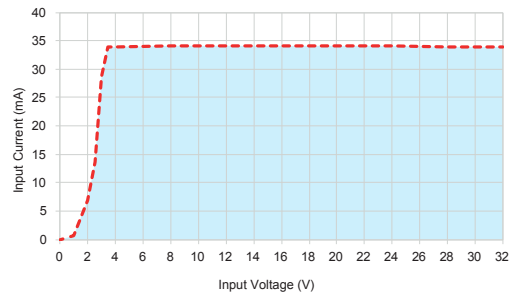

Diagrams

Dimensions (mm)

GNAD front view

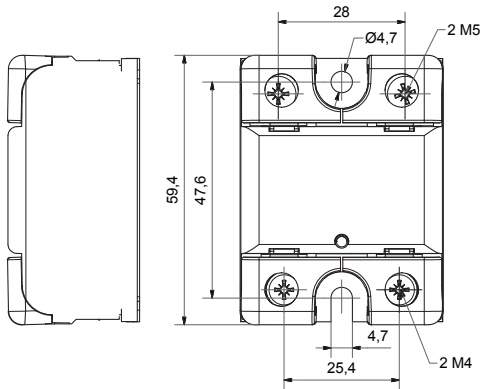

GNAD side view

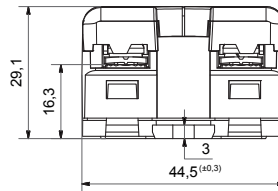

Curves

Surge Current Information

GNAD - 10 A

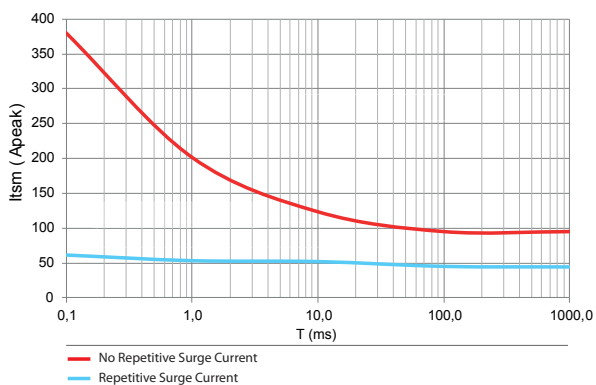

GNAD - 20 A

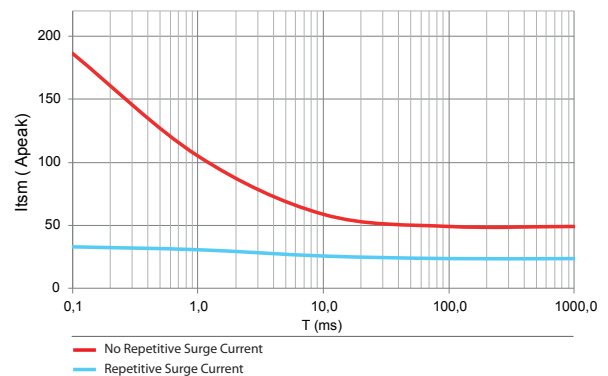

GNAD - 40 A

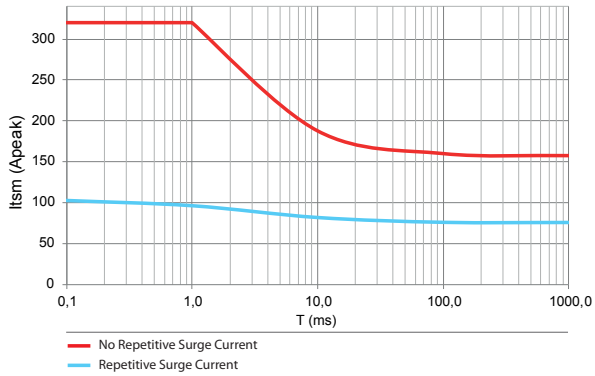

Curves

Thermal Derating Curves

GNAD - 10 A

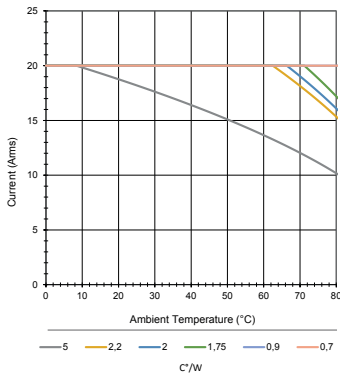

GNAD - 20 A

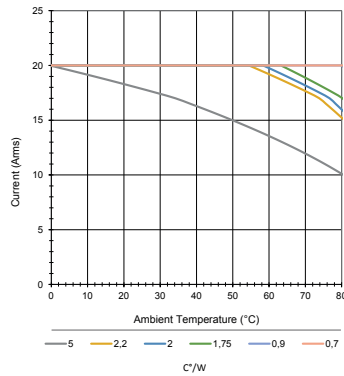

GNAD - 40 A

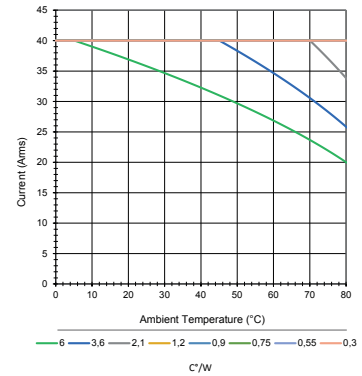

Standards Specifications

IEC/EN61000-4-4 (bursts)  
 IEC/EN61000-4-5 (surge)  
 VIBRATION resistance IEC 60068-2-6  
 SHOCK resistance IEC 60068-2-27

4 kv crit B  
 1 kv crit B  
 10 g  
 50 G (11 ms)



Warning :

The product information contained in this catalogue is given purely as information and does not constitute a representation, warranty or any form of contractual commitment. Crouzet and its subsidiaries reserve the right to modify their products without notice. It is imperative that we should be consulted over any particular use or application of our products and it is the responsibility of the buyer to establish, particularly through all the appropriate tests, that the product is suitable for the use or application. Under no circumstances will our warranty apply, nor shall we be held responsible for any application (such as any modification, addition, deletion, use in conjunction with other electrical or electronic components, circuits or assemblies, or any other unsuitable material or substance) which has not been expressly agreed by us prior to the sale of our products.