

SUMMARY

Wires

Low voltage 5



Image is for illustrative purpose only

Series	0B
Termination type	Female solder
IP rating	50
AWG wire size	30.00 - 22.00
Cable Ø	0.00 - 0.00 mm
Status	active
Matching parts	FGG.0B.305.CLAD52Z

Download

[Request a quote](#)

[Catalog](#)

TECHNICAL DETAILS

Mechanics

Shell Style/Model	EE*: Fixed receptacle, nut fixing (back panel mounting)
Keying	1 key (alpha=0, plug: male contacts, receptacle: female contacts)
Housing Material	Brass (chrome plated [SAE AMS 2460]) shell and collet nut, nickel plated [SAE AMS QQ N 290] brass latch sleeve and mid pieces
Weight	5.15 g

Performance

Configuration	0B.305 : 5 Low Voltage
Insulator	L: PEEK (UL 94 / V-0/1.5)
Rated Current	6.5 Amps

Specifications

Contact Type: Solder
Contact Dia.: 0.7 mm (0.028in)
Bucket Dia.: 0.8 mm (0.031in)
Max. Solid Conductor: 0.34 mm² (AWG 22)
Max. Stranded Conductor: 0.34 mm² (AWG 22)
R (max): 6.1 mOhm
Vtest (contact-shell): 700 V (AC), 1000 V (DC)
Vtest (contact-contact): 1000 V (AC), 1400 V (DC)

LEMO products and services are provided "as is". LEMO makes no warranties or representations with regard to LEMO product & services or use of them, express, implied or statutory, including for accuracy, completeness, or security. The user is fully responsible for his products and applications using LEMO components.

Others

Endurance (Shell): 5000
 Temp (min / max): -55°C / +250°C
 Humidity (max): <=95% [at 60 deg C / 140 F]
 Vibration: 15 g [10 Hz - 2000 Hz]
 Shock Resistance: 100 g [6 ms]
 Climatical Category: 50/175/21
 Shielding (min): 75 dB (10 MHz)
 Shielding (min): 40 dB (1 GHz)
 Salt Spray Corrosion: >1000 hr
 12NC part number: 4022.438.33673

DRAWINGS

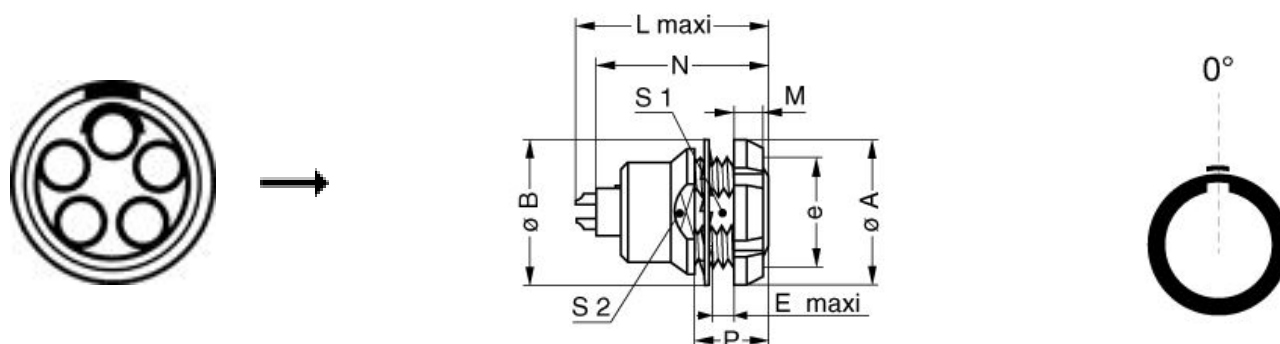

Dimensions

	A	B	E	L	M	N	P	S1	S2	e
mm.	12	12.5	2.4	20.7	2.5	19.1	6.3	8.2	9	M9x0.6
in.	0,47	0,49	0,09	0,81	0,10	0,75	0,25	0,32	0,35	









RECOMMENDED BY LEMO

Tools

Spanner wrench: [Socket for torque wrench DCM.0S.M09.4](#)

LEMO products and services are provided "as is". LEMO makes no warranties or representations with regard to LEMO product & services or use of them, express, implied or statutory, including for accuracy, completeness, or security. The user is fully responsible for his products and applications using LEMO components.

Cables

CMN.05.T22.051QGZE	TPR (medical)	Grey	
CMN.05.T28.029PGCE	PVC	GREY	
CMN.05.T28.029PGZE		Grey	
CMN.05.T28.029PNCE	PVC	Black	
CMN.05.T28.029PNZE			
150250	PVC	Grey	
50090	PVC	Black	
50140	PVC	Grey	
5050	PVC	Black	

LEMO products and services are provided "as is". LEMO makes no warranties or representations with regard to LEMO product & services or use of them, express, implied or statutory, including for accuracy, completeness, or security. The user is fully responsible for his products and applications using LEMO components.