

CONTACT SIZE	MIN. INSUL. O.D.	MAX. INSUL. O.D.	WIRE RANGE [mm ²] REF ONLY
16	.088 [2.23]	.145 [3.68]	14-20 AWG [2.0-0.5]

REV NC DTV06-18S*

REVISIONS			
SYM	DESCRIPTION	DATE	APPROVED
NC	NEW RELEASE PER E.O. P17202	3-29-01	RJR

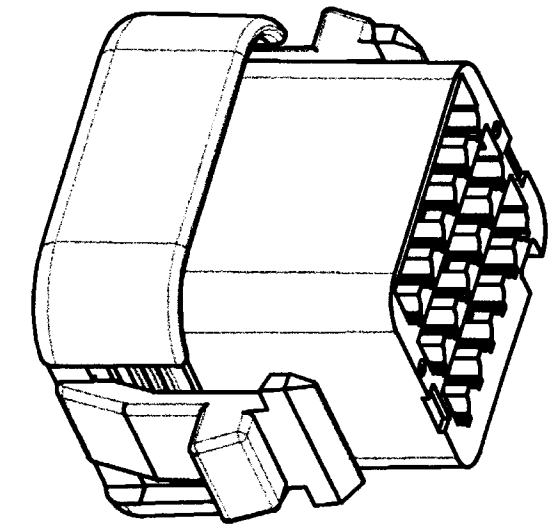
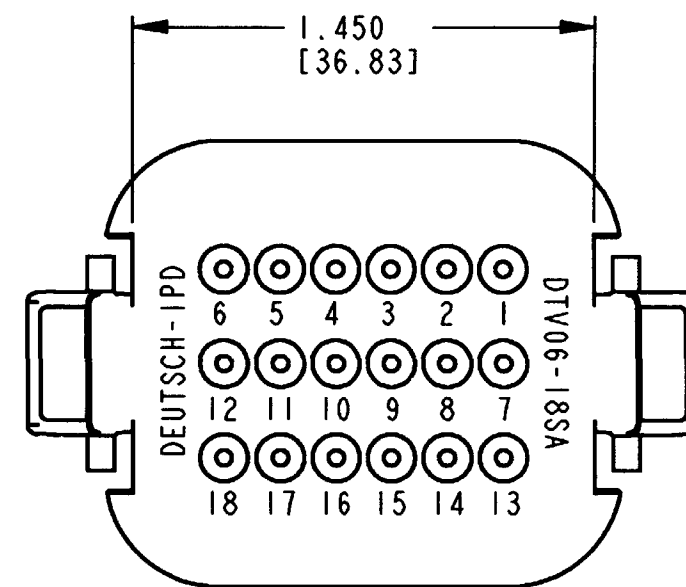
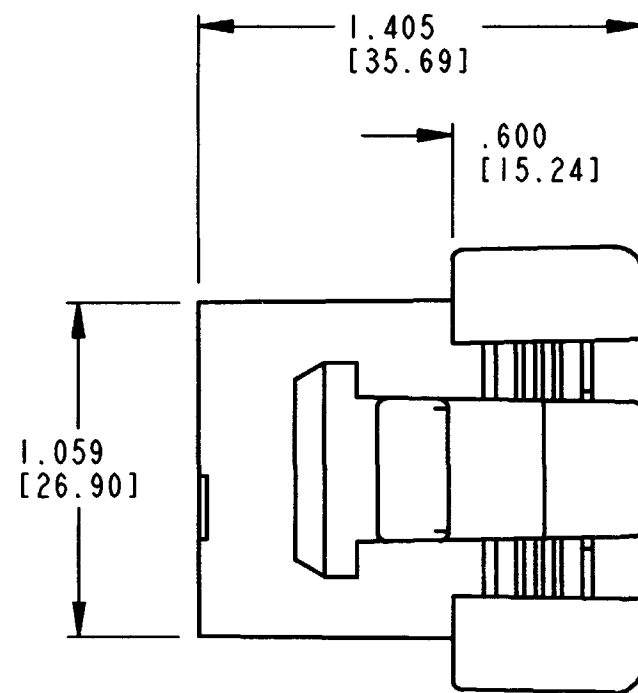

- 6. MATERIAL: HOUSING: PLASTIC; GROMMET: RUBBER.
 - 5. THIS PLUG MATES WITH DTV02-18P*-**** RECEPTACLE. (* = A,B,C,D KEYS; **** = ALL MODIFICATIONS.) CONSULT FACTORY FOR MODS.
 - 4. FOR CONTACT AND WIRE PERFORMANCE AND APPLICATION CHARACTERISTICS, SEE ENVELOPE DRAWINGS 0425-015-0000.
 - 3. ITEMS SOLD SEPARATELY: SECONDARY WEDGE LOCK WV-18S
 - 2. DIMENSION TOLERANCE: ±.025 [0.64]
 - 1. ALL DIMENSIONS ARE INCHES [mm].
- NOTES: UNLESS OTHERWISE SPECIFIED

8. DATE CODE: MONTH IS REPRESENTED BY SEQUENTIAL ALPHA CHARACTERS. EX: A = JANUARY; YEAR IS REPRESENTED BY LAST NUMERICAL DIGIT. EX: 9 = 2009

7. SEE SHEET 2 FOR OTHER KEY ARRANGEMENTS.

SIGNATURE & DATE		PLUG 18 CONTACTS, SIZE 16 KEYS A,B,C & D DTV SERIES	CP 072	MATL. CODE
DR	S. PALLUTH 03/21/01		The Deutsch Company DEUTSCH I.P.D. 3850 INDUSTRIAL AVE. HEMET, CALIF. 92545	
CHK	J.C. [Signature] 3/26/01		B DTV06-18S* DWG SIZE CODE 11139 SHEET 1 OF 2	
PE	S. Palluth 3/22/01			
APPD	[Signature] 3/22/01	ENVELOPE		
SCALE	NONE [W]			

REV NC	DTV06-18S*	REVISIONS			
		SYM	DESCRIPTION	DATE	APPROVED
			SEE SHEET 1	3-29-01	RDR

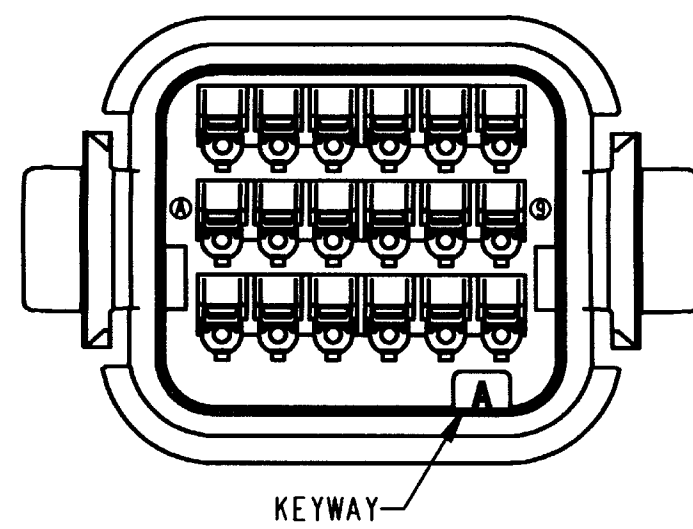

DTV06-18SA
KEY ARRANGEMENT -A-
COLOR: GREY

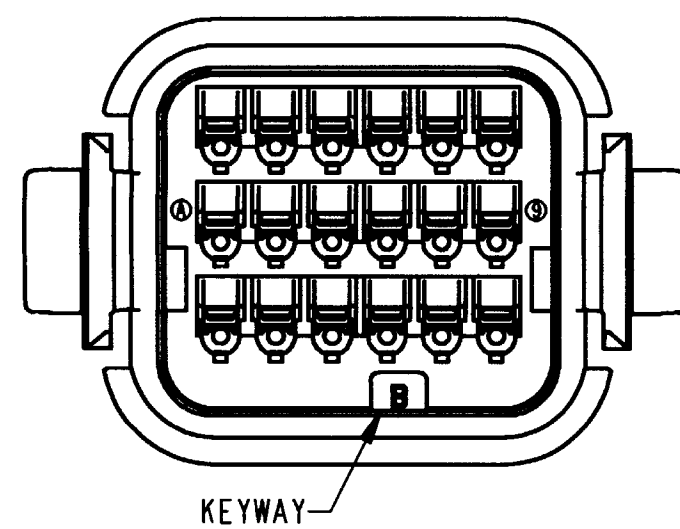

DTV06-18SB
KEY ARRANGEMENT -B-
COLOR: BLACK

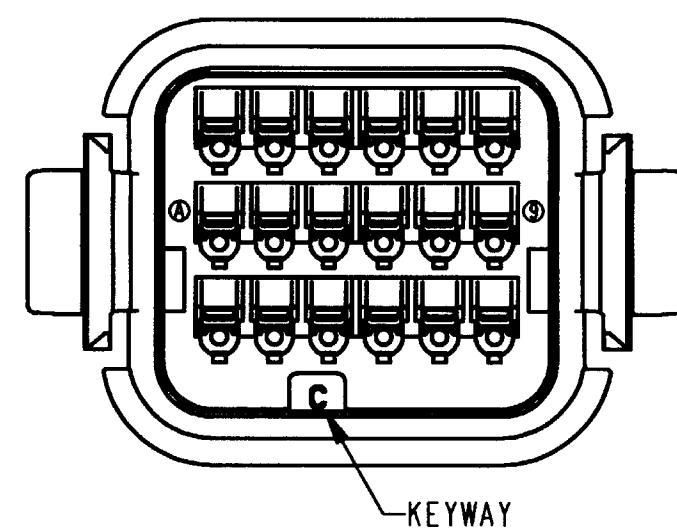

DTV06-18SC
KEY ARRANGEMENT -C-
COLOR: GREEN

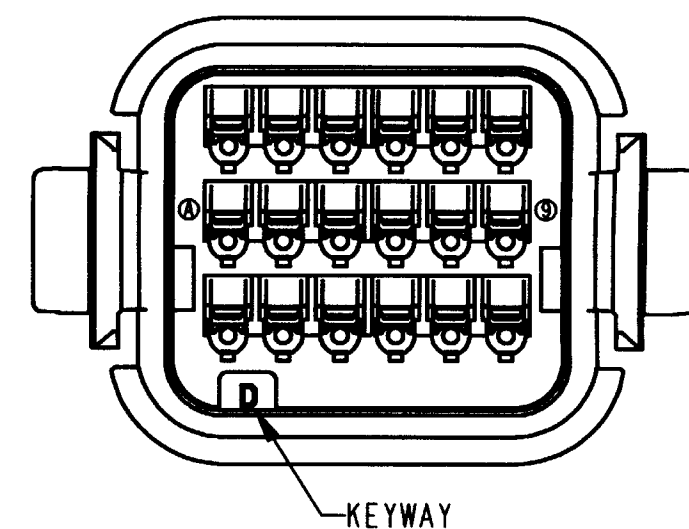

DTV06-18SD
KEY ARRANGEMENT -D-
COLOR: BROWN

NOTES:

SIGNATURE & DATE		PLUG 18 CONTACTS, SIZE 16 KEYS A, B, C & D DTV SERIES	CP 072	MATL. CODE	
DR	S. PALLUTH 03/21/01		The Deutch Company DEUTSCH I. P. D. 3850 INDUSTRIAL AVE. HEMET, CALIF. 92545		
CHK	<i>[Signature]</i> 3/26/01		B	DTV06-18S*	
PE	<i>[Signature]</i> 3/21/01			DWG SIZE	CODE 11139
APPD	<i>[Signature]</i> 3/22/01	ENVELOPE			
SCALE	NONE				