



Typical unit shown for illustration purposes only

DEVELOPMENT OVERVIEW

D1U54T-M-2500-12-HxxC is a series of 2500 W 54.5 mm wide highly efficient AC and HVDC input front end power modules that provide a 12Vdc main output and a standby output. The high power density low-profile packaging achieves >58 W/in³ and provides active current sharing capability, a multifunction status LED, hardware logic signals, PMBus™ digital communications. This power module is ideal for delivering reliable power to servers, workstations, storage systems and other 12 V distributed power architectures.

ORDERING GUIDE

Part Number	Total Output Power at Nominal Input Voltage ^{1,2}		Main Output	Standby Output	Airflow Direction
	200-277 Vac, 190-400 Vdc	100-120 Vac			
D1U54T-M-2500-12-HA3C	2515 W	1275 W	12 Vdc	5.0 Vdc	F → B
D1U54T-M-2500-12-HA4C					F ← B
D1U54T-M-2500-12-HB3C	2536 W	1296 W	12 Vdc	12 Vdc	F → B
D1U54T-M-2500-12-HB4C					F ← B
D1U54T-M-2500-12-HC3C	2509.9 W	1269.9 W	12 Vdc	3.3 Vdc	F → B
D1U54T-M-2500-12-HC4C					F ← B

FEATURES

- 2500 W continuous main 12 Vdc output power¹
- 96% minimum efficiency at 50% load, 80 PLUS® certified Titanium
- Anderson Saf-D-Grid Input Connector for full HVDC range
- Compact high power density of >58 W/in³
- 3.3 / 5.0 / 12 Vdc Standby Output Options
- 54.5 mm x 321.5 mm x 40.0 mm (<1U height)
- Comprehensive Temperature, Current & Voltage fault protection
- N+1 redundancy, hot pluggable
- Active ISHARE for main output includes ORing isolation for both outputs
- PMBus™ 1.2 digital communications
- RoHS Compliant
- Two Year Warranty

INPUT CHARACTERISTICS

Parameter	Conditions	Min.	Nom.	Max.	Units			
Input Voltage Range ^{1,3}		90	100-120	132	Vac			
		180	200-277	305	Vac			
		190	190-400	400	Vdc			
Input AC Source Frequency		47	50 / 60	63	Hz			
Turn-on Input Voltage	Ramp up	74		84	Vac			
		185		192	Vdc			
Turn-off Input Voltage	Ramp down	70		80	Vac			
		180		190	Vdc			
Maximum Input Current	100-120/200-277 Vac, 50 / 60 Hz			16	A			
	190-400 Vdc			15	A			
Inrush Current	Cold start; <200 ms, 264 Vac 25 °C; excludes effects of x-caps			50	Apk			
Power Factor	230 Vac / 60 Hz; 100% load		0.99		%			
Efficiency	230 Vac/230 Vdc, 25 °C Excluding fan load				Min.			
					Units			
					@ 10% load	90.0	90.5	%
					@ 20% load	94.0	94.1	%
					@ 50% load	96.0	96.1	%
@ 100% load	91.0	93.3	%					

OUTPUT VOLTAGE CHARACTERISTICS

Output	Parameter	Conditions	Min.	Nom.	Max.	Units
12 V	Voltage Set Point	230Vac; 50% load; 25 °C; measured at remote sense	11.94	12.00	12.06	Vdc
	Line and Load Regulation ⁵	Measured at power module side of connector	-1		+1.5	%
	Ripple Voltage & Noise ^{4,5}	20MHz bandwidth			120	mV p-p
	Output Current ¹	180-305 Vac; 190-400 Vdc			208.3	Adc
		90-132 Vac			105	Adc
Load Capacitance				30,000	µF	
3.3 Vsb	Voltage Set Point	230 Vac; 50% load; Tamb =25 °C, at remote sense	3.28	3.30	3.32	Vdc
	Line and Load Regulation ⁶	Measured at power module side of connector	3.14	3.30	3.46	Vdc
	Ripple Voltage & Noise ^{4,6}	20 MHz Bandwidth			75	mV p-p
	Output Current				3	Adc
	Load Capacitance				3,000	µF
5 Vsb	Voltage Set Point	230 Vac; 50% load; Tamb =25 °C, Measured at remote sense	4.98	5.00	5.03	Vdc
	Line and Load Regulation ⁶	Measured at power module side of connector	4.76	5.00	5.24	Vdc
	Ripple Voltage & Noise ^{4,6}	20 MHz Bandwidth			75	mV p-p
	Output Current				3	Adc
	Load Capacitance				3,000	µF
12 Vsb	Voltage Set Point	230 Vac; 50% load; Tamb =25 °C, Measured at remote sense	11.94	12.00	12.06	Vdc
	Line and Load Regulation ⁶	Measured at power module side of connector	11.70	12.00	12.30	Vdc
	Ripple Voltage & Noise ^{4,6}	20MHz Bandwidth			120	mV p-p
	Output Current				3	Adc
	Load Capacitance				1,000	µF

1. De-rating applies to certain models, input voltage and temperature conditions; refer to [De-rating](#) tables for details

2. Includes standby output at 100% FL

3. Insert power supply into mating connector prior to applying input voltage

4. Measured with 0.1 µF of ceramic capacitance and 10 µF of tantalum capacitance on each of the power supply outputs. A short coaxial cable to scope is used.

5. Minimum Load of 8.5 A applied to meet these limits.

6. Minimum Load of 0.25 A applied to meet these limits



For full details visit our website:

www.murata-ps.com/rohs



OUTPUT CHARACTERISTICS

Parameter	Conditions	Min.	Typ.	Max.	Units
Startup Time	AC ramp up			3	s
Transient Response	12 V Main 50% load change step (max.), $\geq 10\%$; 1 A/ μ s slew rate; 2,000 μ F output capacitance	-5		+5	% nom
	Recovery Time to within output regulation limits		2		ms
	Vsb, 50% load change step (max.), $\geq 10\%$; 1 A/ μ s slew rate	-5		+5	% nom
	Recovery Time to within Vsb output regulation limits		2		ms
Current sharing accuracy	Main output; 30% -100% full load	-5		+5	%
Hot Swap Transients	All outputs remain in regulation	-5		+5	%
Holdup Time	230-240 Vac / 240-400 V HVDC input voltage ranges, 2500 W load, main output dropping to 10.8V	10			ms
	115-240 Vac / 190-400 V HVDC input voltage ranges, 1200 W load, main output dropping to 10.8 V	20			ms

ENVIRONMENTAL CHARACTERISTICS

Parameter	Conditions	Min.	Typ.	Max.	Units
Storage Temperature Range		-40		70	°C
Operating Temperature Range ^{1,2}	Refer to De-rating curves for details	-5		50	
Operating Humidity	Non-condensing	5		90	%
Storage Humidity	Non-condensing	5		95	
Altitude ^{1,2,3}	De-rating applies ≥ 40 °C intake temperature			4000	m
Shock	30G non-operating				
MTBF	Per Telcordia SR-332 M1C3 @40 °C, 230 Vac, 100% full load	540K			Hrs.
Safety Approval Standards (Pending)	IEC 60950-1:2005, IEC 60950-1:2005/AMD1:2009, IEC 60950-1:2005/AMD2:2013 [CSA] IEC 62368-1:2014 [CSA] CAN/CSA-C22.2 No. 62368-1:14 [CSA] UL 62368-1 2nd Ed. [CSA] EN 62368-1:2014+A11 [TÜV SUD] IS 13252(Part 1):2010/ IEC 60950-1:2005 (BIS) CNS13438 (095/06/01), CNS14336-1 (099/09/30), CNS 15663 5 (102) [BSMI] GB17625.1-2012, GB4943.1-2011, GB/T9254-2008 (Class A) [CQC] K60950-1 (2011-12) [KCC]				
Input Fuse	Dual 20A/420VAC/420DC fuse provided as a series protective element in both input "line" and "neutral" connection				
Weight	Approximately 1.324 kg				

- Meets NEBS abnormal requirements of 55 °C (Sea Level), adjusted to 65°C (@ 1 °C/1,000 ft) to approximate the effects of altitude of 1800M
- Based on a power supply operating in a free air environment. Performance within end user's system may be impacted due to the effects of back-pressure imposed by the end use system design. Power module is protected from OTP faults by internal OTP sensors. Refer to PMBus ACAN for additional details. It is incumbent upon the end-user to ensure sufficient access to airflow when designing the system in which these modules will be installed.
- Meets China safety spacing requirements

AIRFLOW CHARACTERISTICS

P - Q Curve (Front to Back)

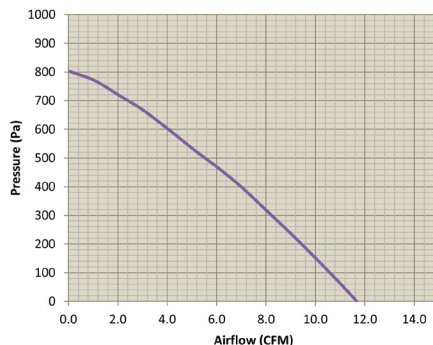

P - Q Curve (Back to Front)

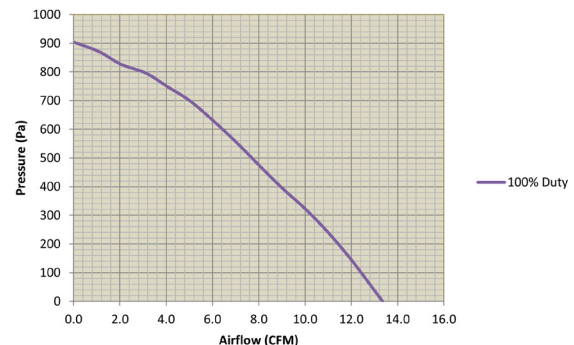

Based on test report dated 5/11/2021, sample serial NF2105S2000J; fan model PFB0412EN-E#11

PROTECTION CHARACTERISTICS

Output Voltage	Parameter	Conditions	Min.	Typ.	Max.	Units
-	Over temperature ²	Auto restart	76	80	84	°C
12V	Overvoltage	Latching ¹	13.0	14	16.0	V
	Overcurrent (180-264 Vac)	Hiccup mode, 5 retries before Latch-off ¹ . Protection is delayed 100 ms to accommodate Peak Power	220		250	
	Overcurrent (90-150 Vac)	Hiccup mode, 5 retries before Latch-off ¹	105		120	A
12Vsb	Overvoltage	Latching ¹	13.0		16.0	V
	Overcurrent	Hiccup	3.1		4.5	A
5.0Vsb	Overvoltage	Latching ¹	5.4		6.2	V
	Overcurrent	Hiccup	3.1		5.0	A
3.3Vsb	Overvoltage	Latching ¹	3.6		4.4	V
	Overcurrent	Hiccup	3.1		5.0	A

EMISSIONS AND IMMUNITY

Parameter	Conditions	Units
Input Current Harmonics	IEC/EN 61000-3-2	Complies with Class A limits
Voltage Fluctuation and Flicker	IEC/EN 61000-3-3	Complies
Conducted Emissions	FCC 47 CFR Part15/CISPR22/EN55032	Class A with 6 dB margin
ESD Immunity	IEC/EN 61000-4-2	±8KV Contact; ±15KV air discharge; Criteria A
Radiated Field Immunity	IEC/EN 61000-4-3	3V/m, 1 KHz, 80% AM, 80 MHz to 1 GHz Criteria A ⁴
Electrical Fast Transients/Burst Immunity	IEC/EN 61000-4-4	Level 3 (2 kV), criteria A ⁴
Surge Immunity	IEC/EN 61000-4-5	Level 3 (2 kV Line-Earth, 1 kV Line-Line), Criteria A ³
RF Conducted Immunity	IEC/EN 61000-4-6	Level 2 (3 V/m) Criteria A ⁴
Voltage Dips, Interruptions	IEC/EN 61000-4-11	230 Vin, 100% load, Phase 0°, Dip 100% Duration 10 ms (A) 230 Vin, 50% load, Phase 0°, Dip 100% Duration 20 ms (Vsb:A, V1:B) 230 Vin, 100% load, Phase 0°, Dip 100% Duration > 20 ms (Vsb, V1:B)

STATUS INDICATOR (SINGLE BICOLOUR LED)

Condition	LED Status
Standby Mode: Main output = OFF; AC PRESENT	Blinking green 1 Hz
Standby Mode: Main output = ON; No faults detected	Solid green
Fault Detected ⁵ ; Main output, Vsb output, Fan, overtemperature, input OVP	Solid Amber
AC input power absent or no I2C slave address detected (See ADDR signal for configuration details); Vsb OVP	Off
Power Supply Warning Event ⁵	Blinking Amber
Cold Redundant mode – “COLD_STANDBY” / “FORCED STANDBY” MODE	Blinking green 2 Hz

ISOLATION CHARACTERISTICS

Parameter	Conditions	Min.	Typ.	Max.	Units
Insulation Safety Rating / Test Voltage	Input to Output - Reinforced	5000			Vdc
	Input to Chassis - Basic	2500			Vdc
Isolation	Output to Chassis (functional isolation only)	500			Vdc

- Latch-off requires recycling either the input power or toggling PS_ON to resume operation
- As detected by the internal air intake PMBus reporting sensor. Warning indication (PMBus status register bits and Amber LED status) occurs at 95 °C nominal and recovers at 90 °C nominal; fault indication and shutdown engages at 100 °C nominal and recovers at 95 °C nominal. Operating above the maximum specified operating temperature is consider abnormal and prolonged operation under such conditions may negatively impact power supply and is not recommended. Should airflow through the power module be inadequate or restricted, the power module's internal hot-spot sensors may act to self-protect by shutting down the main output regardless of the intake airflow temperature. Refer to [PMBus ACAN](#) for additional details such as reading temperature and fault thresholds.
- Measured at power supply's input connector
- Contingent upon final system design
- LED indication is concurrent with the PMBus™ Status_XX Register fault/warn bit flags. LED fault/warn state clears upon removal of fault/warn stimulus however associated PMBus™ set fault/warn bit flags and SMBALERT# signal (faults only) can only be cleared by writing “CLEAR_FAULTS” PMBus command or recycling the input power, or toggling PS_ON signal. Refer to PMBus™ ACAN for further details including fault/warn thresholds, supported register bits and masking capability

STATUS AND CONTROL SIGNALS			
Signal Name	I/O	Description	Interface Details
INPUT_OK Link to: Pin Table	Output	INPUT_OK signal is driven high when input source is present and within acceptable limits and driven low to indicate loss of input power. This signal deasserts ≥ 5 ms before loss of main output and provides an accurate indication of loss of AC input voltage.	Pulled up via 511R to internal house-keeping supply voltage ² and pulled down to DC Return via 10 k Ω resistor
PW_OK (Output OK) Link to: Pin Table	Output	The signal is asserted, driven high, by the power supply to indicate 12V main output is valid. Should a 12V main output fault occur, the PW_OK signal will de-assert + driven low. PW_OK output is driven low to indicate that the main output is outside of lower limit of regulation.	Pulled up internally via 10 k Ω to internal house-keeping supply voltage ² . A logic high >2.0 Vdc A logic low <0.8 Vdc Driven low by internal CMOS buffer (open drain output)
SMBALERT# (FAULT) Link to: Pin Table	Output	SMBALERT# is driven low to alert the system that the power supply has detected a fault condition as defined in the PMBus ACAN, supported STATUS_XX Register fault bits ¹ . This alert asserts when any of the supported STATUS_XX register fault bits are set. This signal is driven high to indicate normal operation. SMBALERT# is de-asserts (fault indication cleared) by either of the following, provided the fault condition is removed: 1) recycling input power 2) Issuing "clear_faults" PMBus command 3) toggling the PS_ON signal The LED fault indication reflects the SMBALERT# status	Pulled up internally via 10 k Ω to house-keeping supply voltage ² . A logic high >2.0 Vdc A logic low <0.8 Vdc Driven low by internal CMOS buffer (open drain output)
PRESENT_L (Power Supply Absent) Link to: Pin Table	Output	The signal is used to detect the presence (installed) of a Power module by the host system and is connected to power module's logic SGND within the power module.	Passive connection to +VSB_Return. A logic low <0.8 Vdc
PS_ON (Main Out Enable/Disable)	Input	This signal ¹⁸ is pulled up, within the power supply, to the internal housekeeping supply. The power supply main 12V output will be enabled when this signal is pulled low (to output return). In the low state the signal input shall not source more than 1mA of current. The 12V main output will be disabled when the input is driven higher than 2.4 V, or open circuited. Cycling this signal shall clear latched fault conditions.	Pulled up internally to internal bias supply ² . A logic high >2.0 Vdc A logic low <0.8 Vdc Input is via CMOS Schmitt trigger buffer

STATUS AND CONTROL SIGNALS																															
Signal Name	I/O	Description	Interface Details																												
ADDR (Address) Link to: Pin Table LED Table	Input	An external pull-down resistor $\leq 180 \text{ k}\Omega$ must be placed on the system/host side between the ADDR pin and +12V Main / VSB_Return to enable/turn-on the main output. This same resistor also sets the slave addresses as defined in the following table:	DC voltage between the limits of 0 and +3.3 Vdc System side pull-down resistor required, $\leq 180 \text{ k}\Omega$																												
		<table border="1"> <thead> <tr> <th>External Resistor Value (K-ohm, $\leq +5\%$) Pin D2</th> <th>INTERNAL CONTROLLER</th> <th>EXTERNAL EEPROM</th> </tr> </thead> <tbody> <tr> <td>0.82</td> <td>0xB0</td> <td>0xA0</td> </tr> <tr> <td>2.7</td> <td>0xB2</td> <td>0xA2</td> </tr> <tr> <td>5.6</td> <td>0xB4</td> <td>0xA4</td> </tr> <tr> <td>8.2</td> <td>0xB6</td> <td>0xA6</td> </tr> <tr> <td>15</td> <td>0xB8</td> <td>0xA8</td> </tr> <tr> <td>27</td> <td>0xBA</td> <td>0xAA</td> </tr> <tr> <td>56</td> <td>0xBC</td> <td>0xAC</td> </tr> <tr> <td>180</td> <td>0xBE</td> <td>0xAE</td> </tr> </tbody> </table>		External Resistor Value (K-ohm, $\leq +5\%$) Pin D2	INTERNAL CONTROLLER	EXTERNAL EEPROM	0.82	0xB0	0xA0	2.7	0xB2	0xA2	5.6	0xB4	0xA4	8.2	0xB6	0xA6	15	0xB8	0xA8	27	0xBA	0xAA	56	0xBC	0xAC	180	0xBE	0xAE	
		External Resistor Value (K-ohm, $\leq +5\%$) Pin D2		INTERNAL CONTROLLER	EXTERNAL EEPROM																										
		0.82		0xB0	0xA0																										
		2.7		0xB2	0xA2																										
		5.6		0xB4	0xA4																										
		8.2		0xB6	0xA6																										
		15		0xB8	0xA8																										
		27		0xBA	0xAA																										
56	0xBC	0xAC																													
180	0xBE	0xAE																													
A serial clock [®] line compatible with PMbus™ Power Systems Management Protocol Part 1 – General Requirements Rev 1.2. No additional internal capacitance is added that would affect the speed of the bus. The signal is provided with a series isolator device to disconnect the internal power supply bus in the event that the power module is unpowered.	VIL is 0.8 V maximum VOL is 0.4 V maximum when sinking 3 mA VIH is 2.1 V minimum																														
A serial data [®] line compatible with PMbus™ Power Systems Management Protocol Part 1 – General Requirements Rev 1.2. The signal is provided with a series isolator device to disconnect the internal power supply bus in the event that the power module is unpowered.	VIL is 0.8 V maximum VOL is 0.4 V maximum when sinking 3 mA VIH is 2.1 V minimum																														
Remote sense connections intended to be connected at and sense the voltage at the point of load. The voltage sense will interact with the internal module regulation loop to compensate for voltage drops due to connection resistance between the output connector and the load. If remote sense compensation is not required then the voltage can be configured for local sense by: <ol style="list-style-type: none"> V1_SENSE directly connected to main output V1_SENSE_RTN directly connected to +12V Main/VSB_Return 	Compensation for up to 0.12 Vdc total connection drop (output and return connections).																														
This signal is connected between sharing units forming an ISHARE bus. It is a bi-directional analog bus voltage controls the current share between sharing units. The power module responds to change in bus voltage and also can change the bus voltage based on the load drawn from it. For single Power module, the voltage on the pin/ISHARE bus would read approximately 8 Vdc at 100% load. For two identical units sharing the same 100% load this would read approximately 4 Vdc for perfect current sharing (i.e. 50% module load capability per unit). This signal is also used by cold redundant enabled power supplies to determine Main output on/off state.	Analogue voltage: +8 V maximum; 10 k Ω to +12V_RTN																														
1. PMBus command SMBALERT_MASK write transactions are support; the system/host can configure the specific fault bits that effect SMBALERT# 2. Approximately 3.1 Vdc for 3.3 / 12Vsb models or 4.8 Vdc for 5Vsb models, internal reference "STBY_PULL"																															

Murata Power Solutions

TIMING SPECIFICATIONS

Unless otherwise specified, the following notes apply to all timing specifications:

1. $T_a = 25\text{ }^\circ\text{C}$, V_{in} & $V_{in\text{ nom.}} = 200\text{-}240\text{ Vac}$
2. Resistive load, 100% full load, both outputs

Turn-On Delay & Output Rise Time

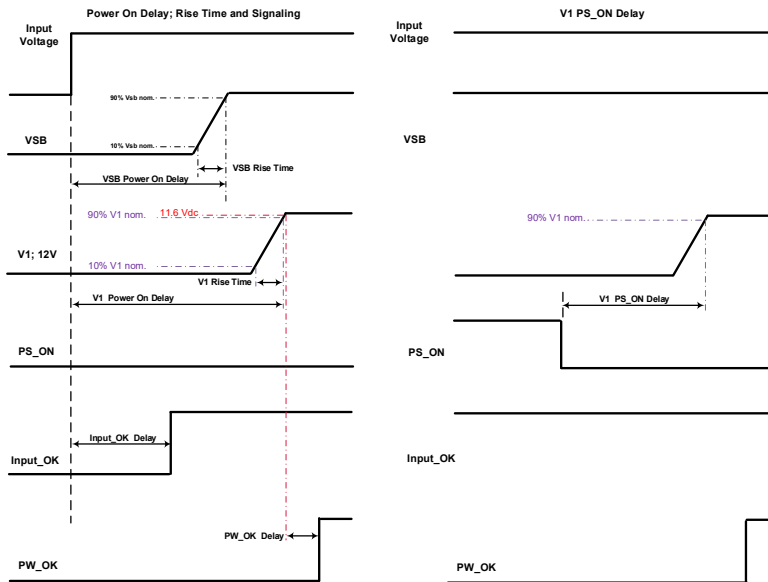

Time	Min	Max
Vsb Rise time; see Fig. 1	3 ms	9 ms
V1 Rise time; see Fig. 2	7 ms	15 ms
Vsb Power-on-delay; see Fig. 3		2700 ms
V1 Power-on-delay; see Fig. 4		3000 ms
V1 PS_ON delay; see Fig. 5	100 ms	400 ms
V1 PW_OK delay; see Fig. 6	100 ms	400 ms
Input_OK detect; see Fig. 7	100 ms	1500 ms

Shutdown by PS_ON. Fall Time and Signaling

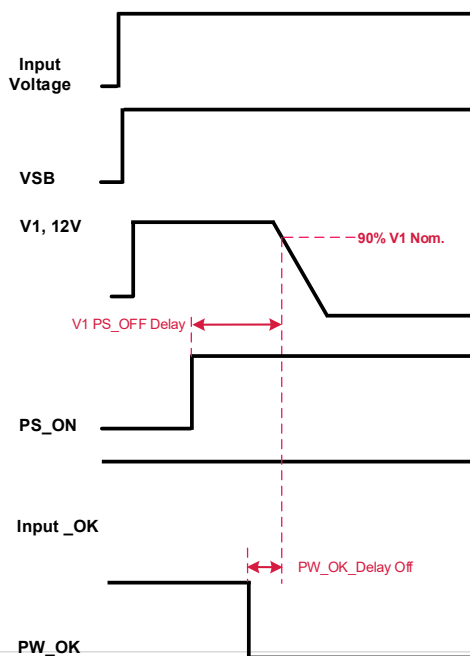

Turn-Off Timing	Min	Max	Notes
V1 PS_OFF delay	0 ms	5 ms	
PW_OK delay off	1 ms		

TIMING SPECIFICATIONS

Power Removal Holdup and Signaling

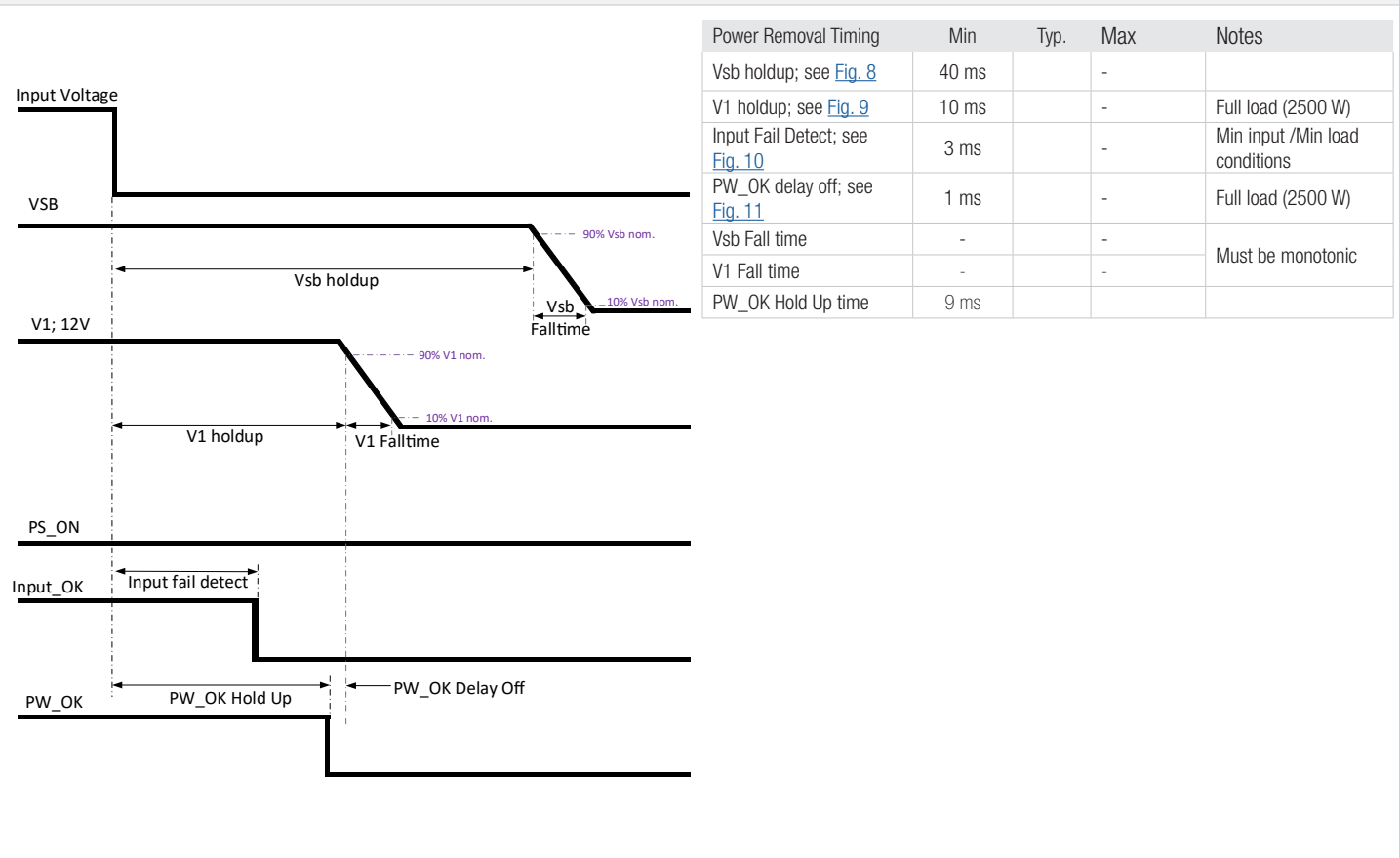

TYPICAL PERFORMANCE DATA

TIMING CHARACTERISTICS

The following terms may be used interchangeably throughout this section:
 "Enable" = "PS_ON" signal; "V1" = 12V Main output; "V2" = Vsb output; "PGOOD" = PW_OK

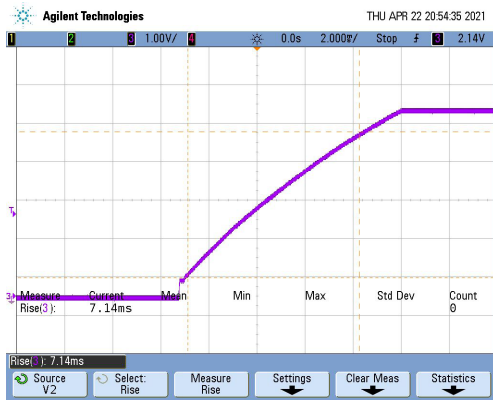

Fig. 1
 Vsb output risetime; 25C 230Vac in, 100% load



Fig. 2
 12V main output rise-time; 25C 230Vac in, 100% load

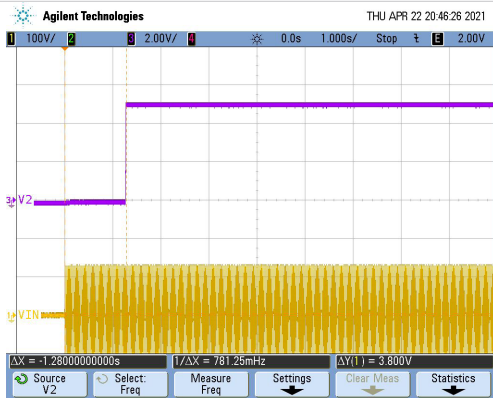

Fig. 3
 Vsb power on delay; 25C 230Vac in, 100% load

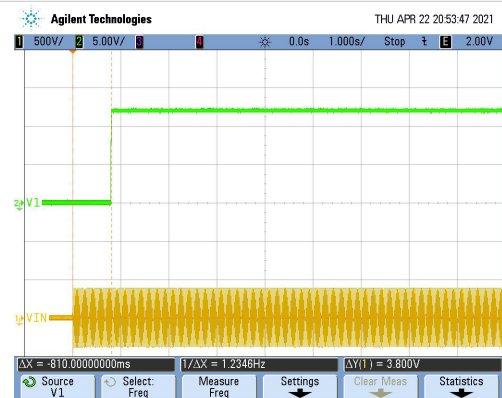

Fig. 4
 12V main power on delay; 25C 230Vac in, 100% load

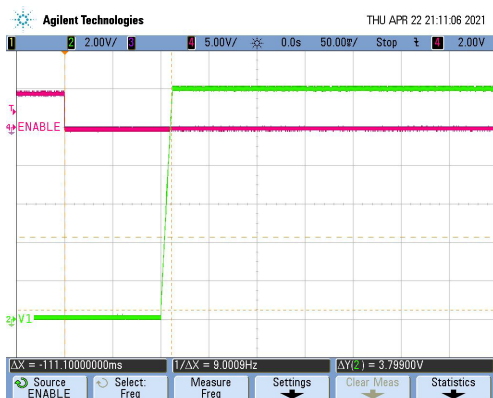

Fig. 5
 12V main PS_ON delay; 25C 230Vac in, 100% load



Fig. 6
 V1 PW_OK delay; 25C 230Vac in, 100% load

TYPICAL PERFORMANCE DATA

TIMING CHARACTERISTICS

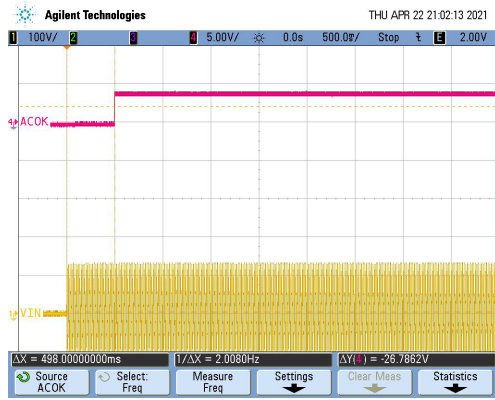

Fig. 7

Vin Detect, 90vrms (60hz) input, 25C 230Vac in, Min. load



Fig. 8

Vsb hold-up; 25C 230Vac in, 100% load

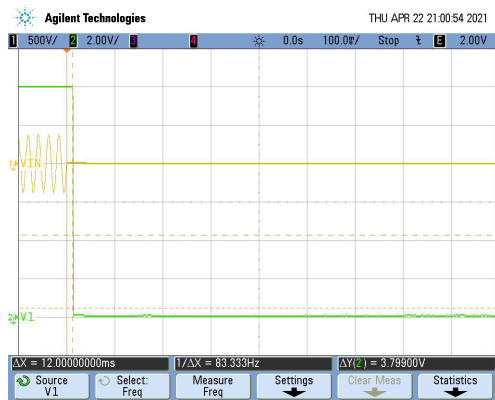

Fig. 9

V1 holdup; 25C 230Vac in, 100% load

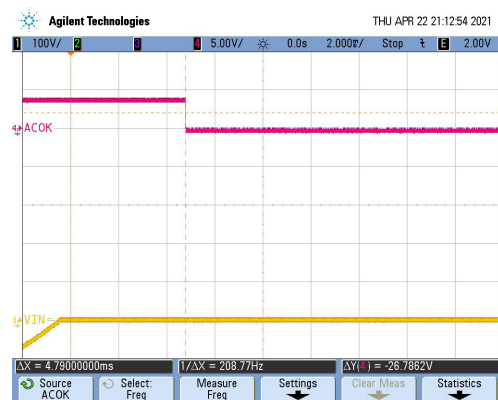

Fig. 10

Input Fail detect; 25C; 90Vac input; Min. Load

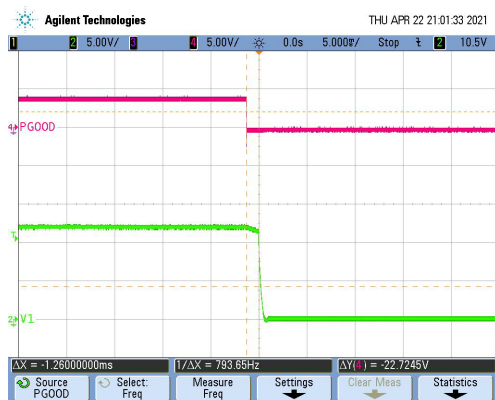

Fig. 11

PW_OK delay off; 25C 230Vac in, 100% load

TYPICAL PERFORMANCE DATA

Efficiency Performance

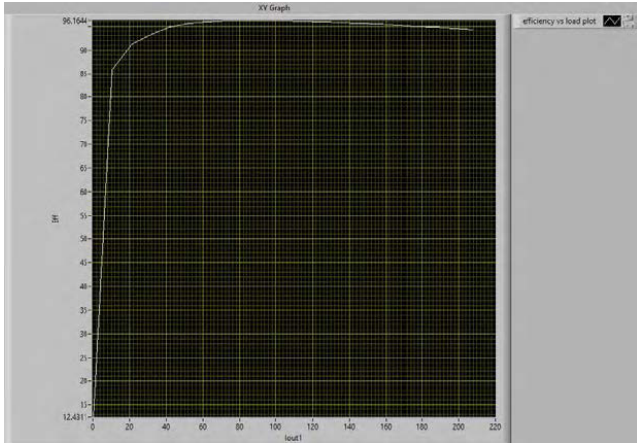

Fig. 12
Efficiency; 230Vac input 25C

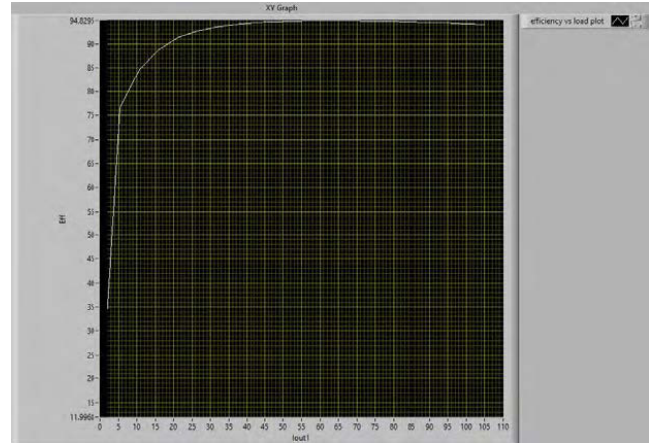

Fig. 13
Efficiency; 115Vac input 25C

POWER DE-RATING VS TEMPERATURE & INPUT VOLTAGE

The following tables illustrate the maximum Main 12V output power and current vs air intake temperature and nominal input voltage. The standby output may be loaded up to 100% FL without further impact to De-rating.

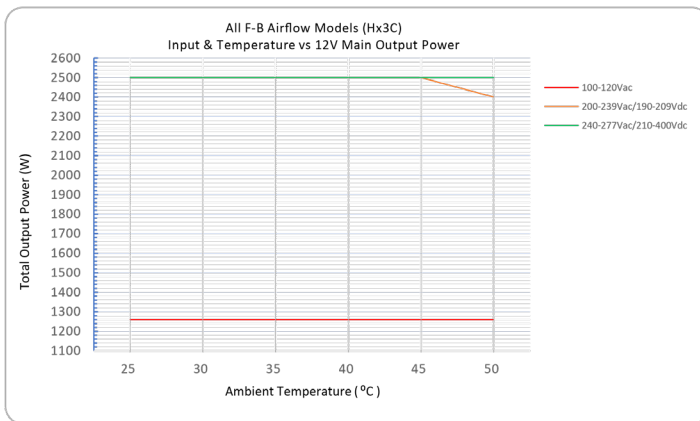

Fig. 14
Main Output Power De-rating table Front to Back airflow models (Hx3C)

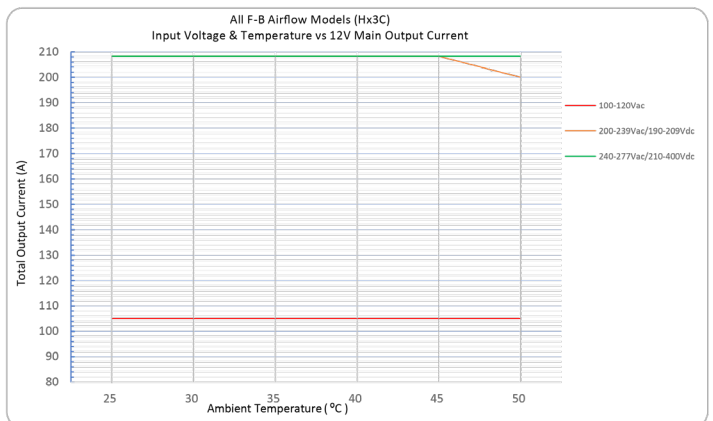

Fig. 15
Main Output Current De-rating table Front to Back airflow models (Hx3C)

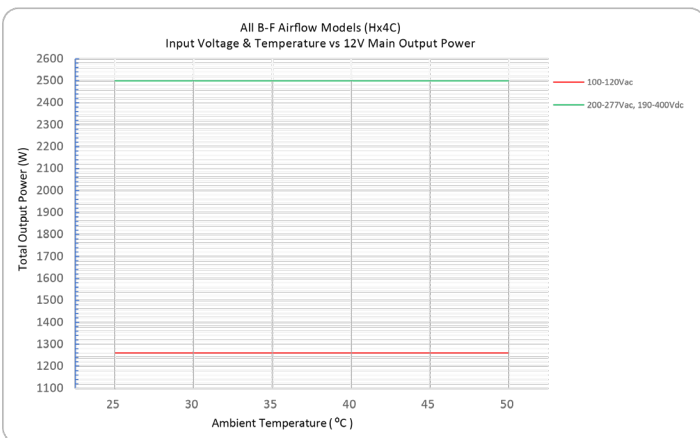

Fig. 16
Main Output Power De-rating table Back to Front airflow models (Hx4C)

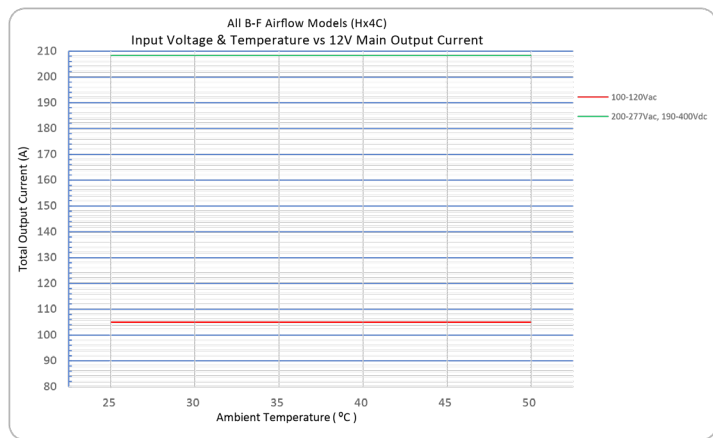
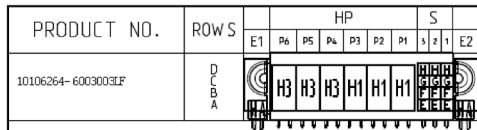
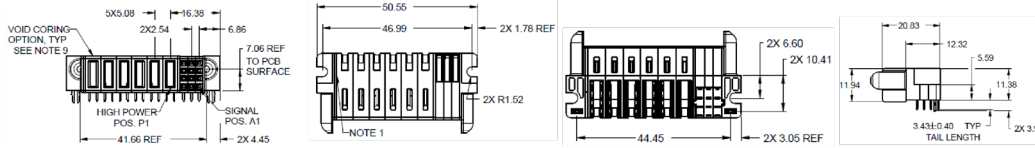

Fig. 17
Main Output Current De-rating table Front to Back airflow models (Hx4C)

Link [back to front page](#)

DC OUTPUT & SIGNAL INTERFACE CONNECTOR

System Side: FCI/Amphenol 10106264-6003003LF



CODE	DESCRIPTION
E	STD SIGNAL CONTACT, ROW A
F	STD SIGNAL CONTACT, ROW B
G	STD SIGNAL CONTACT, ROW C
H	STD SIGNAL CONTACT, ROW D
H1	MLBF HIGH POWER CONTACT(3.43)
H3	STD HIGH POWER CONTACT(3.43)
HA	METAL HOLD DOWN

Power Module Side: FCI/Amphenol 10106262-6003006LF

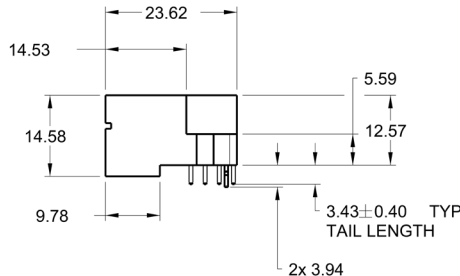
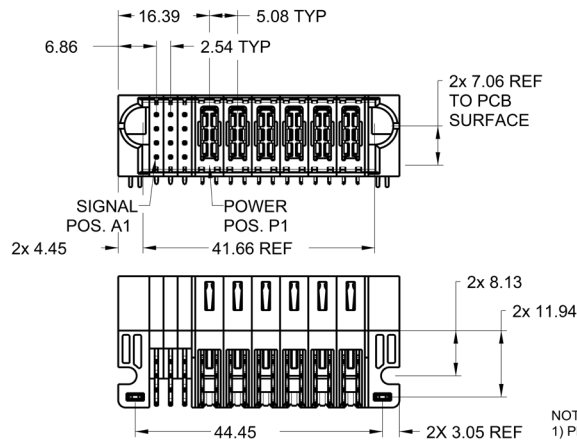
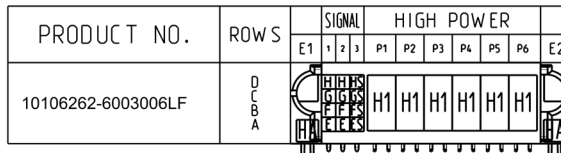
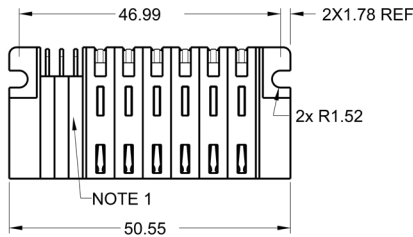

CODE	DESCRIPTION
E	MLBF SIGNAL CONTACT, ROW A (3.43)
ES	MLBF2 SIGNAL CONTACT, ROW A (3.43)
F	MLBF SIGNAL CONTACT, ROW B (3.43)
FS	MLBF2 SIGNAL CONTACT, ROW B (3.43)
G	MLBF SIGNAL CONTACT, ROW C (3.43)
GS	MLBF2 SIGNAL CONTACT, ROW C (3.43)
H	MLBF SIGNAL CONTACT, ROW D (3.43)
H1	STD HIGH POWER CONTACT (3.43)
HA	METAL HOLD DOWN
HS	MLBF2 SIGNAL CONTACT, ROW D (3.43)

- NOTES:
- 1) PRODUCT MARK:
PART NUMBER AND DATE CODE TO BE MARKED ON THIS SURFACE .
THE MARK CAN BE OMITTED IF THERE IS NOT ENOUGH SPACE ON THIS SURFACE.
 - 2) MATERIALS:
-HOUSING : HIGH TEMP THERMOPLASTIC WITH GLASS FIBER, UL94V-0, BLACK.
-POWER CONTACT : HIGH CONDUCTIVITY COPPER ALLOY.
-SIGNAL CONTACT : COPPER ALLOY.
 - 3) PLATING SPECIFICATION : 10116351
 - 4) DENOTES CONNECTOR KEEP OUT ZONE.
 - 5) DATUM AND BASIC DIMENIONS ARE ESTABLISHED BY CUSTOMER.
 - 6) ALL HOLE DIAMETERS ARE FINISHED HOLE SIZES.
 - 7) 1.15+/-0.025MM DRILLED HOLE PLATED WITH 0.00762MM MIN SN OVER 0.0254-0.0762MM CU PLATING TO ACHIEVE A 1.02+/-0.07MM HOLE.
 - 8) THE HOUSING WILL WITHSTAND EXPOSURE TO 265 °C PEAK TEMPERATURE FOR 10 SECONDS IN A WAVE SOLDER APPLICATION.
 - 9) THIS PRODUCT MEETS EUROPEAN UNION DIRECTIVES AND OTHER COUNTRY REGULATIONS AS DESCRIBED IN GS-47-0004.
 - 10)PRODUCT SPECIFICATION : GS-12-658.
APPLICATION SPECIFICATION : GS-20-141.
PRODUCT PACKAGE SPECIFICATION : GS-14-1502.

(CONTINUED)

DC OUTPUT & SIGNAL INTERFACE CONNECTOR

PIN ASSIGNMENTS

Pin	Signal Name	Comments
P4, P5, P6	V1	+ 12V main output
P1, P2, P3	V1 & V2 RETURN	+12V Main/VSB output_Return
A3	SDA	Short Pin1 I2C data signal line; shorter MLFB pin; Link to signal details
B3	SCL	Short Pin1 I2C clock signal line; shorter MLFB pin; Link to signal details
C3	PS_ON	Short Pin1 Remote on/off Short; shorter MLFB pin
D3	SMBALERT#	Short Pin1 2C alert signal; shorter MLFB pin; Link to signal details
A2	V1_SENSE_R	- Remote Sense/ return; Link to signal details
B2	V1_SENSE	+ Remote Sense; Link to signal details
C2	PW_OK	Power OK; Link to signal details
D2	ADDR	Address Selection (select by external pull down resistor); Link to signal details
A1	PRESENT_L	PS Present; Link to signal details
B1	Vsb	Standby output
C1	INPUT_OK	Indicates input power status; Link to signal details
D1	ISHARE	Current share bus; Link to signal details

WIRING DIAGRAM

1 + 1 WIRING EXAMPLE

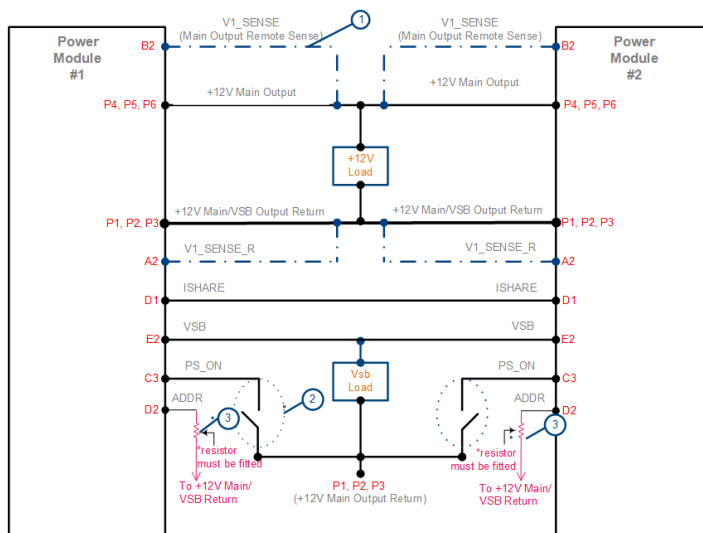

- ① Dotted lines show optional remote sense connections. Optional remote sense lines can be attached to a load that is a distance away from the power supply to improve regulation at the load.
- ② FET, BJT, wire or switch (debounced) to turn on +12V Main Output
- ③ ≤180K External resistor must be fitted between the ADDR pin and +12V/VSB return in order to enable power supply. This resistor value also sets the PMBus Slave Addressing. Refer to the signal table for address options

CURRENT SHARING NOTES

1. Main Output current sharing is achieved using the active current share method.
2. Current sharing can be achieved with or without the remote (V_SENSE) connected to the common load.
3. +Vsb Outputs can be tied together for redundancy but total combined output power must not exceed the rated standby power of a single unit. The +Vsb output has an internal ORing MOSFET for additional redundancy/internal short protection.
4. Main output power of units sharing must not exceed the rated power of a single unit during power up.
5. The current sharing pin D1 is connected between sharing units (forming an ISHARE bus). It is an input and/or an output (bi-directional analog bus) as the voltage on the line controls the current share between sharing units. A power supply will respond to a change in this voltage but a power supply can also change the voltage depending on the load drawn from it. On a single unit the voltage on the pin (and the common ISHARE bus) would read approximately 8VDC at 100% load (power module capability). For two units sharing the same load this would read approximately 4 Vdc for perfect current sharing (i.e. 50% power capability per unit).
6. The load for both the main 12V and the Vsb outputs at initial startup shall not be allowed to exceed the capability of a single unit. The load can be increased after a delay of 3 sec (minimum), to allow all sharing units to achieve steady state regulation

CONNECTOR; AC/HVDC INPUT, POWER MODULE

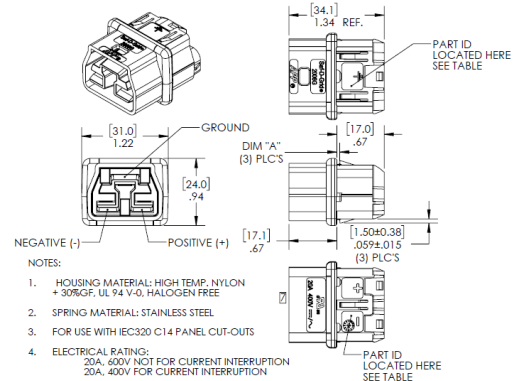
Part Number	Description	Outline
Anderson Saf-D-Grid® 2006G1-NC-BK Receptacle	<p>This power module provides a panel-mounted, two-position receptacle for application of input power.</p> <p>The internal connections from the receptacle to the PCB utilize highly flexible wires and solder terminals to ensure ample float for the end-user's mating power cable (not provided).</p> <p>The internal connections are comprised of the following items</p> <p>Solder Terminal: QTY 3 Anderson 2016G1-LPBK Line (+) Wire: 14AWG (41x30 stranding) Neutral (-) Wire: 14AWG (41x30 stranding) Ground Wire: 16AWG (26x30 stranding)</p>	 <p>NOTES:</p> <ol style="list-style-type: none"> HOUSING MATERIAL: HIGH TEMP. NYLON + 30%GF, UL 94 V-0, HALOGEN FREE SPRING MATERIAL: STAINLESS STEEL FOR USE WITH IEC-320 C14 PANEL CUT-OUTS ELECTRICAL RATING: 20A, 400V NOT FOR CURRENT INTERRUPTION 20A, 400V FOR CURRENT INTERRUPTION TEMPERATURE RATING: 105°C

MECHANICAL OUTLINE

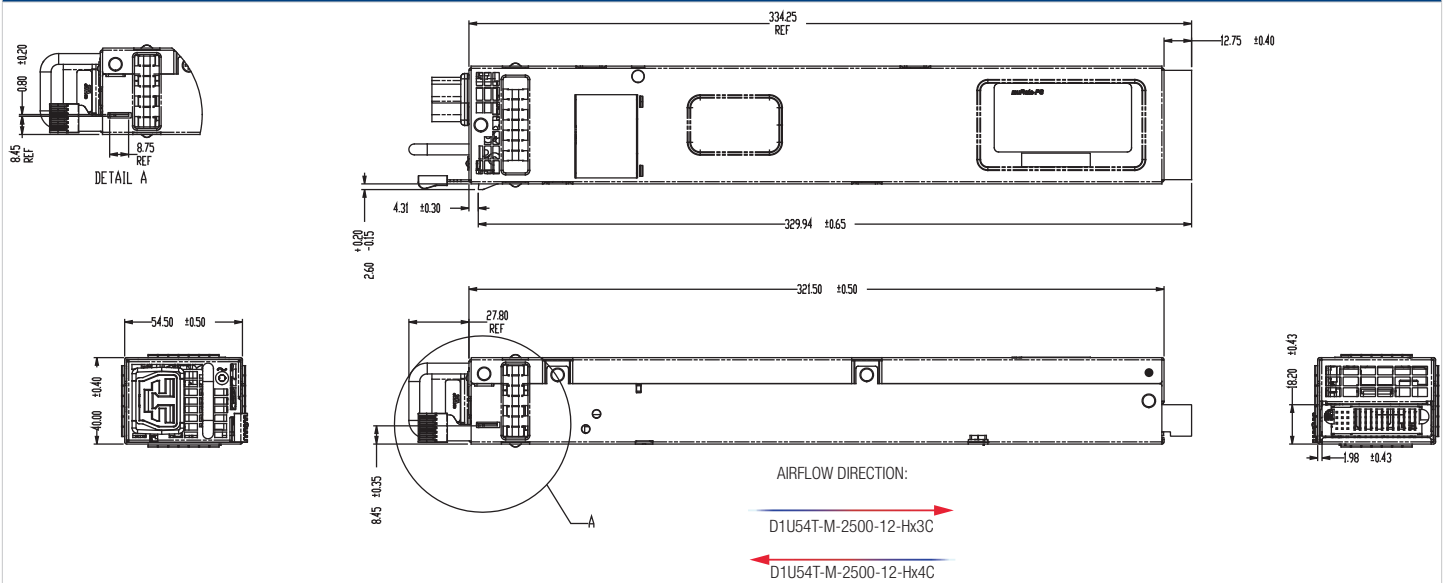

- This drawing is a graphical representation of the product and may not show all fine details. Please contact Murata for 3D model for details
- Reference File: D75090020161_R1_14APR2020
- Dimensions in mm, Material: 0.80mm hot dipped galvanized steel, Grade G60 minimum spangle finished with a CR(6+) free corrosion resistant coating

OPTIONAL ACCESSORIES	
Description	Part Number
Connector Card	D1U54P-12-CONC2K
AC Line Cord [Ⓢ] , Adapts Saf-D-Grid [®] 400V to IEC 320 C14 or C20	Anderson Power Products (Saf-D-Grid [®] To IEC 320 cable configurations): 2050KN1-BK: C14, 1M Length, 14 AWG SJT 2050KN2-BK: C14 2M Length, 14 AWG SJT 2050KN3-BK: C14, 3M Length, 14 AWG SJT 2050KH1-BK: C20, 1M Length, 14 AWG SJT 2050KH2-BK: C20, 2M Length, 14 AWG SJT 2050KH3-BK: C20 3M Length, 14 AWG SJT 2058KN1-BK: C20, 1M Length, 12 AWG SJT 2058KN2-BK: C20, 2M Length, 12 AWG SJT 2058KN3-BK: C20 3M Length, 12 AWG SJT Contact your Anderson Power Products distributor for additional options, pricing and availability.

Ⓢ It is incumbent upon the end user to ensure operation with an input cable system that complies with the electrical code and safety requirements of the country, or region of deployment.

APPLICATION NOTES		
Document Number	Description	URL Link to Document
ACAN-82	D1U54P-12-CONC2K , Output Connector Card	Click to open ACAN-82
ACAN-122	D1U54T-M-2500-12-HxxC PMBus™ Protocol	Click to open ACAN-122

Murata Power Solutions, Inc.
 129 Flanders Rd. Westborough,
 Ma 01581, USA.
 ISO 9001 REGISTERED



This product is subject to the following operating requirements and the Life and Safety Critical Application Sales Policy. Refer to: <https://www.murata-ps.com/requirements/>
 Murata Power Solutions, Inc. ("Murata") makes no representation that the use of its products in the circuits described herein, or the use of other technical information contained herein, will not infringe upon existing or future patent rights. The descriptions contained herein do not imply the granting of licenses to make, use, or sell equipment constructed in accordance therewith. Buyer represents and agrees that it has all the necessary expertise to create and implement safeguards that anticipate dangerous consequences of failures, monitor failures and their consequences, lessen the likelihood of failures that might cause harm, and take appropriate remedial actions. Buyer will fully indemnify Murata, its affiliated companies, and its representatives against any damages arising out of the use of any Murata products in safety-critical applications. Specifications are subject to change without notice.
 © 2023 Murata Power Solutions, Inc