

# SINGLE ROW PRE-WIRED (TYPE WD)

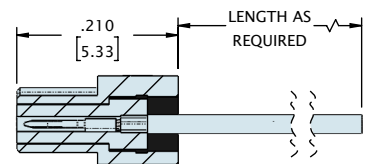
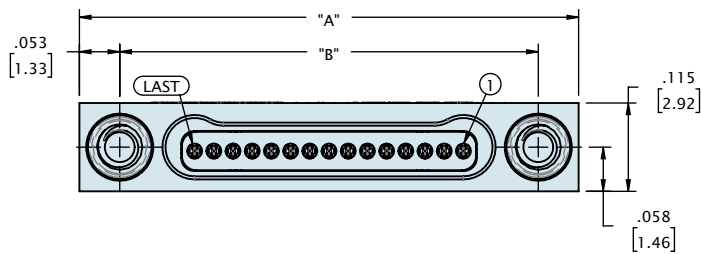
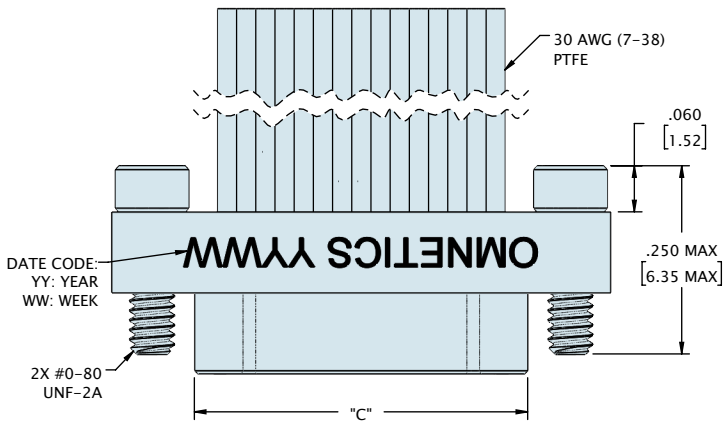
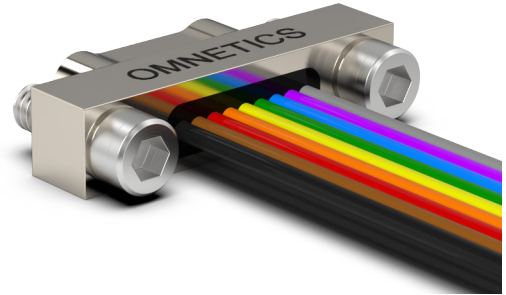
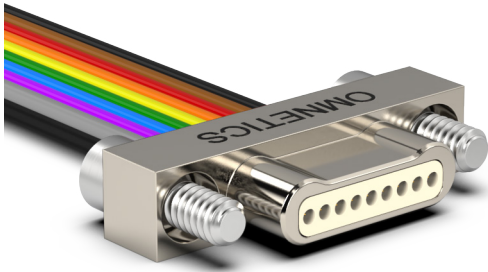

JACKSCREW NOT SHOWN FOR CLARITY

CONTACTS	"A"	"B"	"C"
05	.400 [10.16]	.295 [7.49]	.184 [4.67]
09	.500 [12.70]	.395 [10.03]	.284 [7.21]
15	.650 [16.51]	.545 [13.84]	.434 [11.02]
21	.800 [20.32]	.695 [17.65]	.584 [14.83]
25	.900 [22.86]	.795 [20.19]	.684 [17.37]
31	1.050 [26.67]	.945 [24.00]	.834 [21.18]
37	1.200 [30.48]	1.095 [27.81]	.984 [24.99]
51	1.550 [39.37]	1.445 [36.70]	1.334 [33.88]

DIMENSIONS IN [ ] ARE IN MILLIMETERS AND ARE FOR REFERENCE ONLY

# SINGLE ROW PRE-WIRED (TYPE WD)

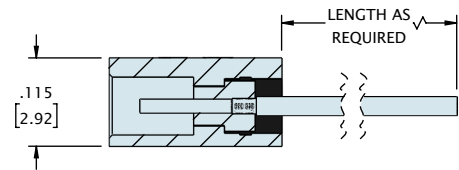
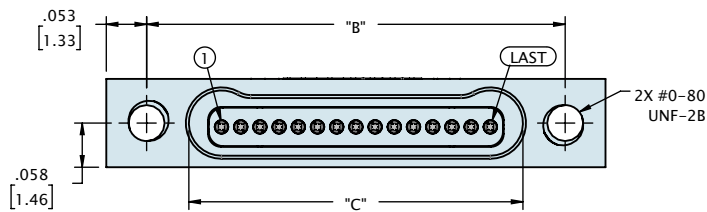
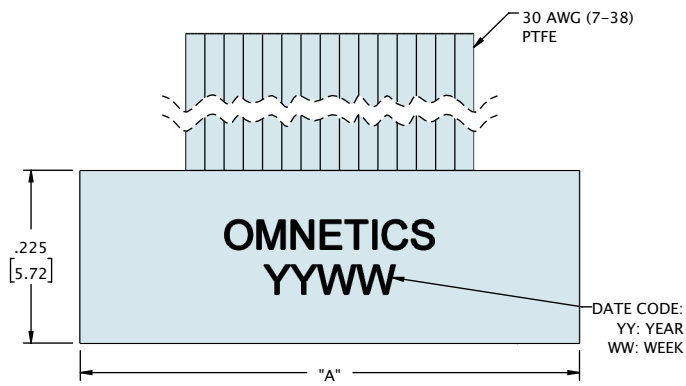

CONTACTS	"A"	"B"	"C"
05	.400 [10.16]	.295 [7.49]	.185 [4.70]
09	.500 [12.70]	.395 [10.03]	.285 [7.24]
15	.650 [16.51]	.545 [13.84]	.435 [11.05]
21	.800 [20.32]	.695 [17.65]	.585 [14.86]
25	.900 [22.86]	.795 [20.19]	.685 [17.40]
31	1.050 [26.67]	.945 [24.00]	.835 [21.21]
37	1.200 [30.48]	1.095 [27.81]	.985 [25.02]
51	1.550 [39.37]	1.445 [36.70]	1.335 [33.91]

DIMENSIONS IN [ ] ARE IN MILLIMETERS AND ARE FOR REFERENCE ONLY