

MOSFET – Dual N-Channel, POWERTRENCH®

20 V, 4 A, Q1: 68 mΩ, Q2: 100 mΩ

FDMC6890NZ

General Description

FDMC6890NZ is a compact single package solution for DC to DC converters with excellent thermal and switching characteristics. Inside the Power 33 package features two N-channel MOSFETs with low on-state resistance and low gate charge to maximize the power conversion and switching efficiency. The Q1 switch also integrates gate protection from unclamped voltage input.

Features

- Q1: N-Channel
 - ◆ Max $R_{DS(on)}$ = 68 mΩ at $V_{GS} = 4.5$ V, $I_D = 4$ A
 - ◆ Max $R_{DS(on)}$ = 100 mΩ at $V_{GS} = 2.5$ V, $I_D = 3$ A
- Q2: N-Channel
 - ◆ Max $R_{DS(on)}$ = 100 mΩ at $V_{GS} = 4.5$ V, $I_D = 4$ A
 - ◆ Max $R_{DS(on)}$ = 150 mΩ at $V_{GS} = 2.5$ V, $I_D = 2$ A
 - ◆ Low Gate Charge
- These Device is Pb-Free, Halide Free and is RoHS Compliant

Applications

- DC-DC Conversion

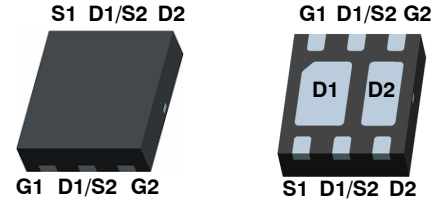

WDFN6 3x3, 0.95P
(Power 33)
CASE 511DT

MARKING DIAGRAM

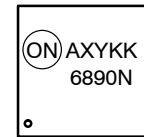

6890N = Specific Device Code
A = Assembly Location
XY = 2-Digit Date Code
KK = 2-Digit Lot Run Traceability Code

PIN CONNECTIONS

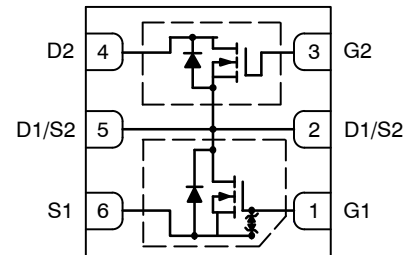

ORDERING INFORMATION

See detailed ordering and shipping information on page 9 of this data sheet.

FDMC6890NZ

MAXIMUM RATINGS (T_A = 25°C unless otherwise noted)

Symbol	Parameter	Q1	Q2	Unit
V _{DS}	Drain to Source Voltage	20	20	V
V _{GS}	Gate to Source Voltage	±12	±12	V
I _D	Drain Current	– Continuous		A
		– Pulsed		
P _D	Power Dissipation (Steady State) Q1 (Note 1a)	1.92		W
	Power Dissipation (Steady State) Q2	1.78		
T _J , T _{STG}	Operating and Storage Junction Temperature Range	–55 to +150		°C

Stresses exceeding those listed in the Maximum Ratings table may damage the device. If any of these limits are exceeded, device functionality should not be assumed, damage may occur and reliability may be affected.

THERMAL CHARACTERISTICS

Symbol	Parameter	Value	Unit
R _{θJA}	Thermal Resistance, Junction to Ambient Q1 (Note 1a)	65	°C/W
R _{θJA}	Thermal Resistance, Junction to Ambient Q2	70	

ELECTRICAL CHARACTERISTICS (T_J = 25°C unless otherwise noted)

Symbol	Parameter	Test Condition	Type	Min	Typ	Max	Unit
--------	-----------	----------------	------	-----	-----	-----	------

OFF CHARACTERISTICS

BV _{DSS}	Drain to Source Breakdown Voltage	I _D = 250 μA, V _{GS} = 0	Q1 Q2	20 20	– –	– –	V
$\frac{\Delta BV_{DSS}}{\Delta T_J}$	Breakdown Voltage Temperature Coefficient	I _D = 250 μA, Referenced to 25°C	Q1 Q2	– –	13 12	– –	mV/°C
I _{DSS}	Zero Gate Voltage Drain Current	V _{DS} = 16 V, V _{GS} = 0 V	Q1 Q2	– –	– –	1 1	μA
I _{GSS}	Gate to Source Leakage Current	V _{GS} = ±12 V, V _{DS} = 0 V	Q1 Q2	– –	– –	±10 ±100	μA nA

ON CHARACTERISTICS

V _{GS(th)}	Gate to Source Threshold Voltage	V _{GS} = V _{DS} , I _D = 250 μA	Q1 Q2	0.6 0.6	0.9 1.0	2 2	V
$\frac{\Delta V_{GS(th)}}{\Delta T_J}$	Gate to Source Threshold Voltage Temperature Coefficient	I _D = 250 μA, Referenced to 25°C	Q1 Q2	– –	–3 –3	– –	mV/°C
R _{DS(on)}	Drain to Source On Resistance	V _{GS} = 4.5 V, I _D = 4 A V _{GS} = 2.5 V, I _D = 3 A	Q1	– –	58 77	68 100	mΩ
		V _{GS} = 4.5 V, I _D = 4 A V _{GS} = 2.5 V, I _D = 2 A	Q2	– –	67 102	100 150	
g _{FS}	Forward Transconductance	V _{DS} = 5 V, I _D = 4 A	Q1 Q2	– –	10 7	– –	S

DYNAMIC CHARACTERISTICS

C _{iss}	Input Capacitance	V _{DS} = 10 V, V _{GS} = 0 V, f = 1 MHz	Q1	–	205	270	pF
			Q2	–	190	250	
C _{oss}	Output Capacitance		Q1	–	60	80	pF
			Q2	–	60	80	
C _{rss}	Reverse Transfer Capacitance	Q1	–	40	60	pF	
		Q2	–	35	55		
R _g	Gate Resistance	f = 1 MHz	Q1	–	3.3	–	Ω
			Q2	–	2.8	–	

FDMC6890NZ

ELECTRICAL CHARACTERISTICS ($T_J = 25^\circ\text{C}$ unless otherwise noted) (continued)

Symbol	Parameter	Test Condition	Type	Min	Typ	Max	Unit
--------	-----------	----------------	------	-----	-----	-----	------

SWITCHING CHARACTERISTICS

$t_{d(\text{on})}$	Turn-On Delay Time	$V_{DD} = 10\text{ V}$, $I_D = 4\text{ A}$, $R_{\text{GEN}} = 6\ \Omega$	Q1	-	4	10	ns
			Q2	-	4	10	
t_r	Rise Time		Q1	-	13	22	ns
			Q2	-	12	21	
$t_{d(\text{off})}$	Turn-Off Delay Time		Q1	-	10	19	ns
			Q2	-	7	14	
t_f	Fall Time		Q1	-	6	12	ns
			Q2	-	6	12	
$Q_{g(\text{TOT})}$	Total Gate Charge at 4.5 V	$V_{GS} = 0\text{ V}$ to 4.5 V , $V_{DD} = 10\text{ V}$, $I_D = 4\text{ A}$	Q1	-	2.4	3.4	nC
			Q2	-	1.8	2.6	
$Q_{g(2)}$	Total Gate Charge at 2 V	$V_{DD} = 10\text{ V}$, $I_D = 4\text{ A}$	Q1	-	1.4	1.9	nC
			Q2	-	0.6	0.8	
Q_{gs}	Gate to Source Gate Charge		Q1	-	0.4	-	nC
			Q2	-	0.5	-	
Q_{gd}	Gate to Drain "Miller" Charge		Q1	-	0.9	-	nC
			Q2	-	0.8	-	

DRAIN-SOURCE DIODE CHARACTERISTICS

V_{SD}	Source to Drain Diode Forward Voltage	$V_{GS} = 0\text{ V}$, $I_S = 4\text{ A}$	Q1	-	0.94	1.25	V
			Q2	-	0.92	1.25	
t_{rr}	Reverse Recovery Time	$I_F = 4\text{ A}$, $di/dt = 100\text{ A}/\mu\text{s}$	Q1	-	18	27	ns
			Q2	-	17	26	
Q_{rr}	Reverse Recovery Charge		Q1	-	9	14	nC
			Q2	-	10	15	

Product parametric performance is indicated in the Electrical Characteristics for the listed test conditions, unless otherwise noted. Product performance may not be indicated by the Electrical Characteristics if operated under different conditions.

NOTES:

- $R_{\theta JA}$ is determined with the device mounted on a 1 in² pad 2 oz copper pad on a 1.5 x 1.5 in. board of FR-4 material. $R_{\theta JC}$ is guaranteed by design while $R_{\theta CA}$ is determined by the user's board design.

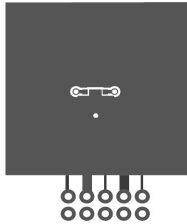

a. $65^\circ\text{C}/\text{W}$ when mounted on a 1 in² pad of 2 oz copper



b. $150^\circ\text{C}/\text{W}$ when mounted on a minimum pad of 2 oz copper

- Pulse Test: Pulse Width < 300 μs , Duty Cycle < 2.0%

TYPICAL CHARACTERISTICS (Q1 N-CHANNEL) ($T_J = 25^\circ\text{C}$ unless otherwise noted)

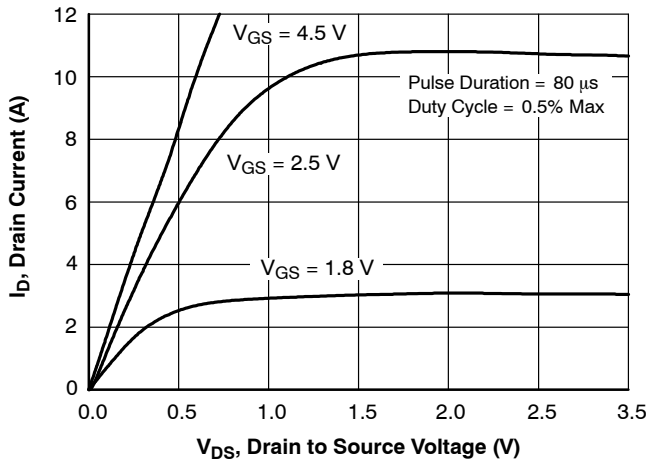

Figure 1. On Region Characteristics

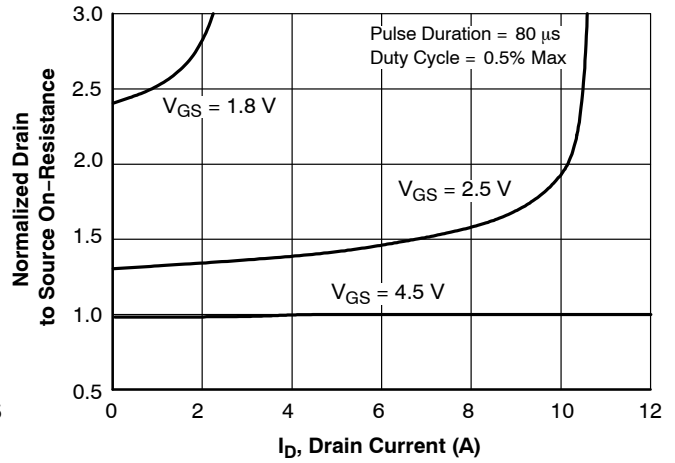

Figure 2. Normalized On-Resistance vs. Drain Current and Gate Voltage

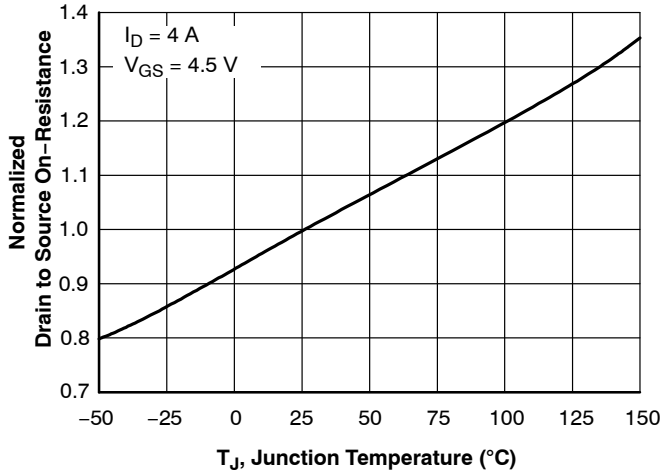

Figure 3. Normalized On-Resistance vs. Junction Temperature

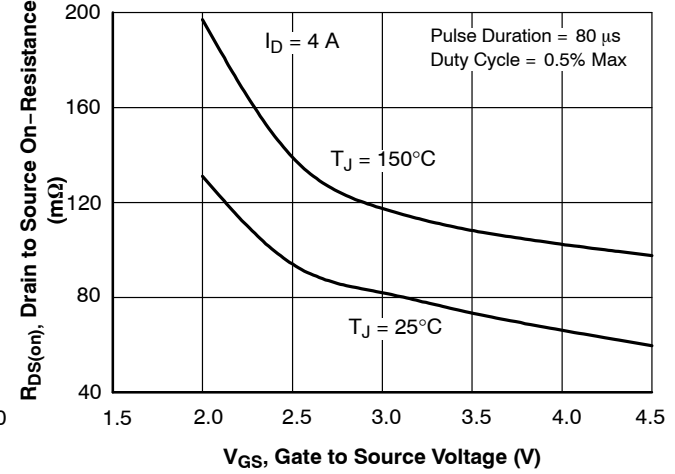

Figure 4. On-Resistance vs. Gate to Source Voltage

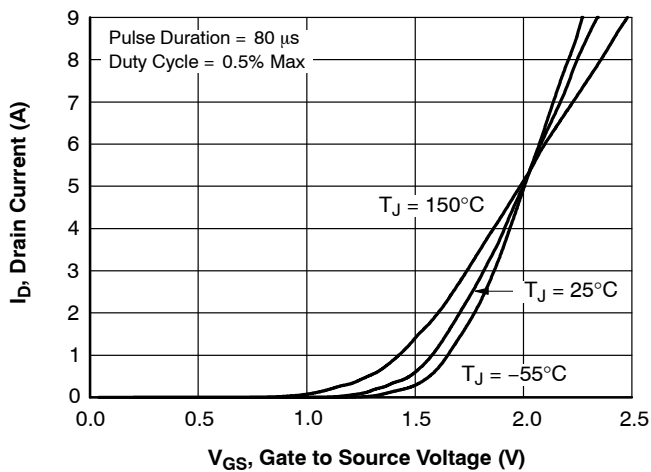

Figure 5. Transfer Characteristics

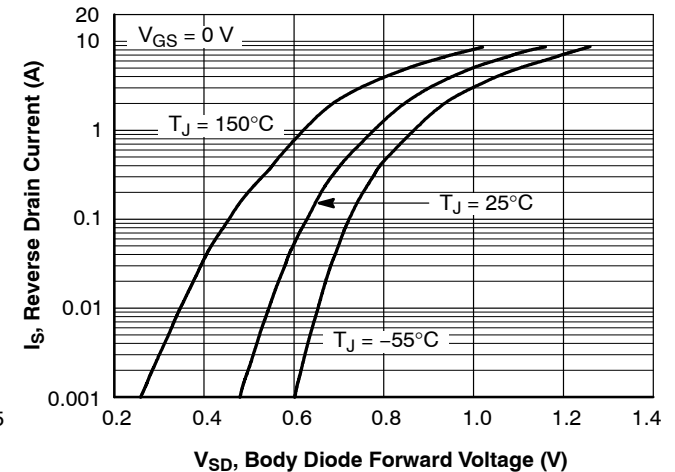

Figure 6. Source to Drain Diode Forward Voltage vs. Source Current

TYPICAL CHARACTERISTICS (Q1 N-CHANNEL) ($T_J = 25^\circ\text{C}$ unless otherwise noted) (continued)

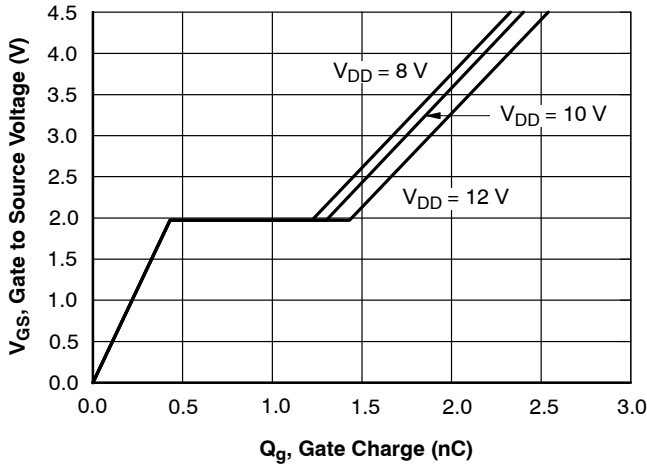

Figure 7. Gate Charge Characteristics

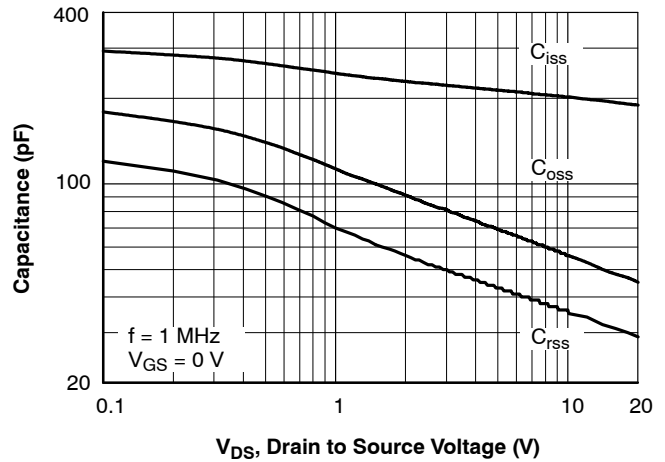

Figure 8. Capacitance vs. Drain to Source Voltage

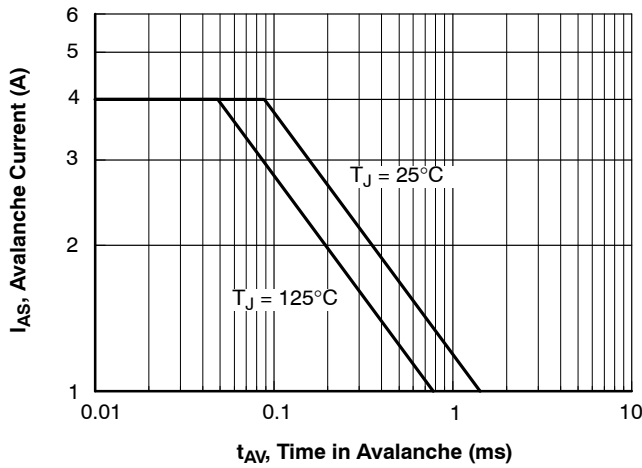

Figure 9. Unclamped Inductive Switching Capability

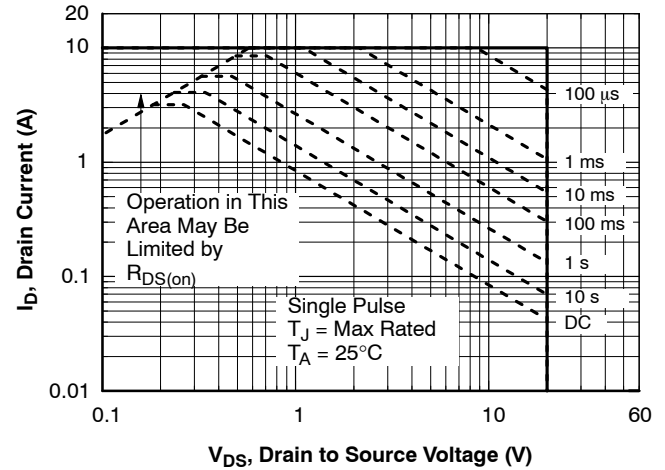

Figure 10. Forward Bias Safe Operating Area

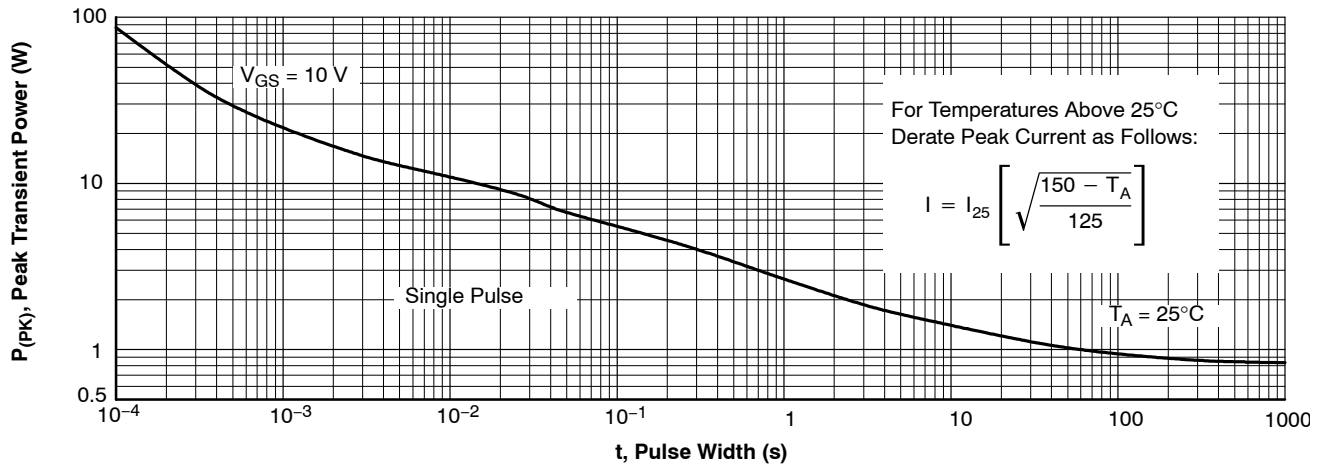

Figure 11. Single Pulse Maximum Power Dissipation

FDMC6890NZ

TYPICAL CHARACTERISTICS (Q1 N-CHANNEL) ($T_J = 25^\circ\text{C}$ unless otherwise noted) (continued)

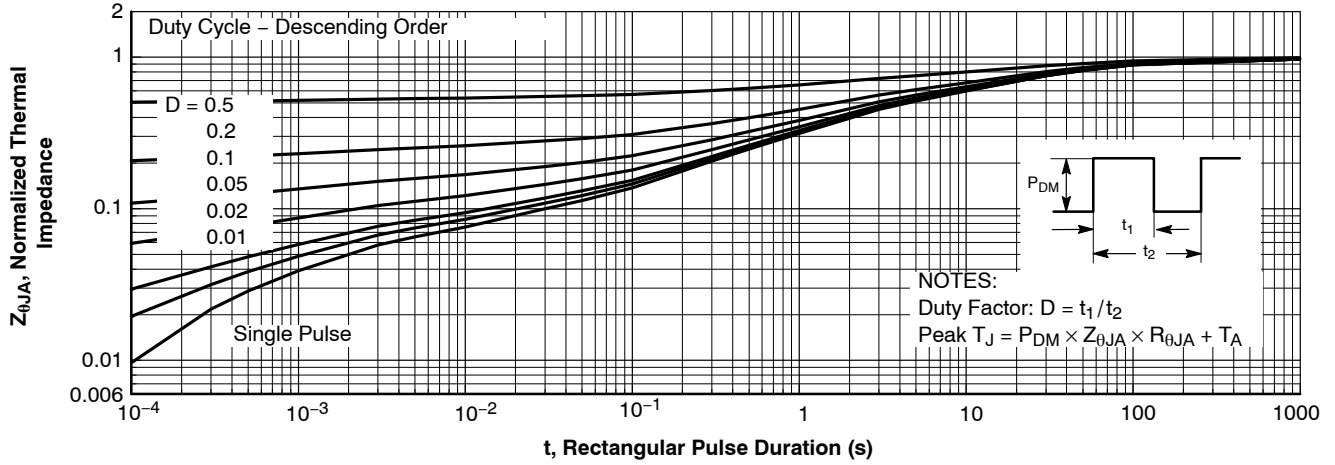

Figure 12. Transient Thermal Response Curve

TYPICAL CHARACTERISTICS (Q2 N-CHANNEL) ($T_J = 25^\circ\text{C}$ unless otherwise noted)

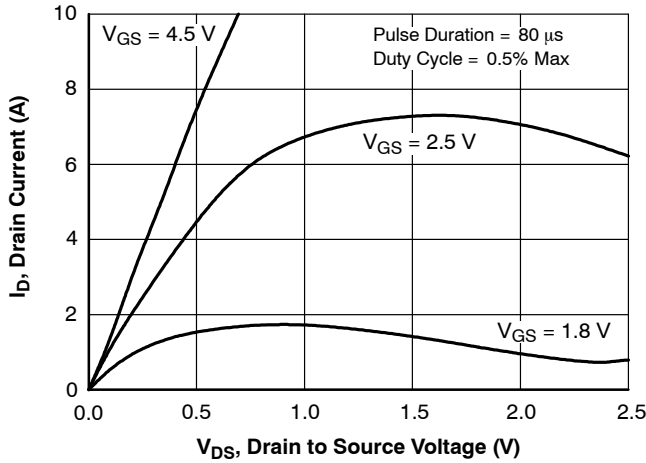

Figure 13. On Region Characteristics

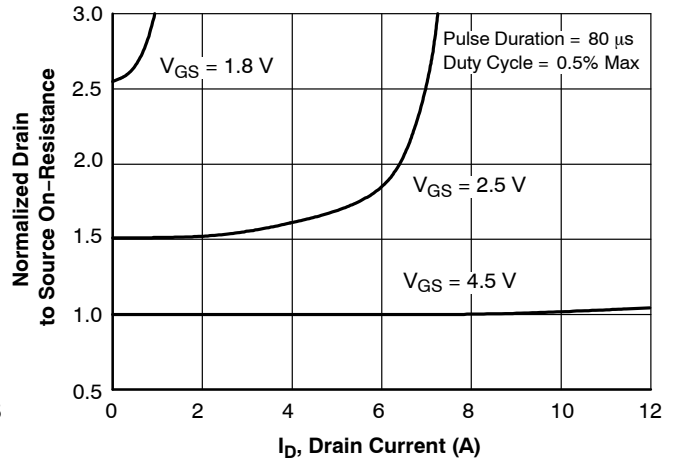

Figure 14. Normalized On-Resistance vs. Drain Current and Gate Voltage

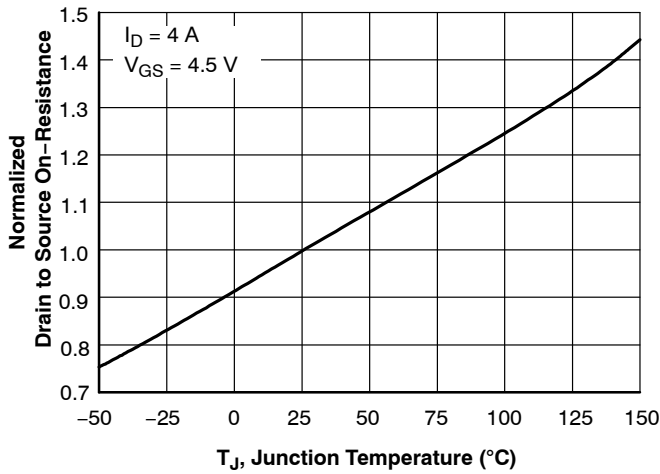

Figure 15. Normalized On Resistance vs. Junction Temperature

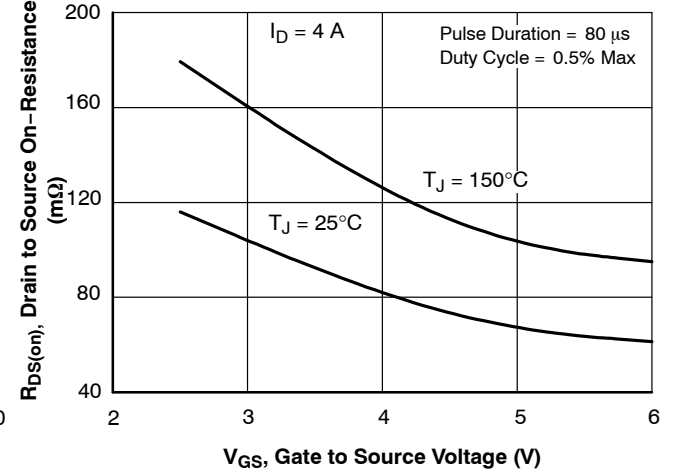

Figure 16. On-Resistance vs. Gate to Source Voltage

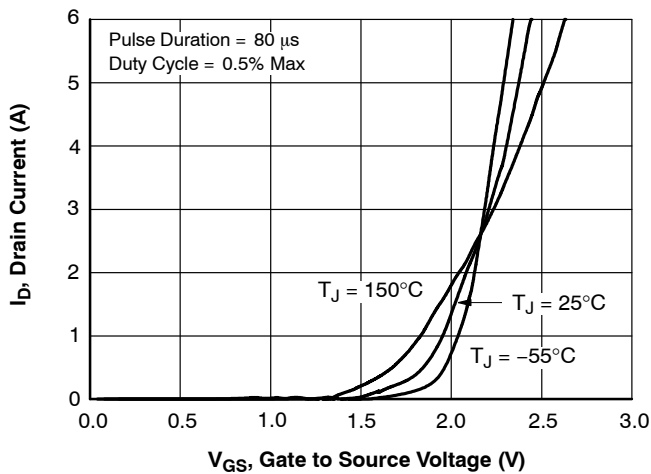

Figure 17. Transfer Characteristics

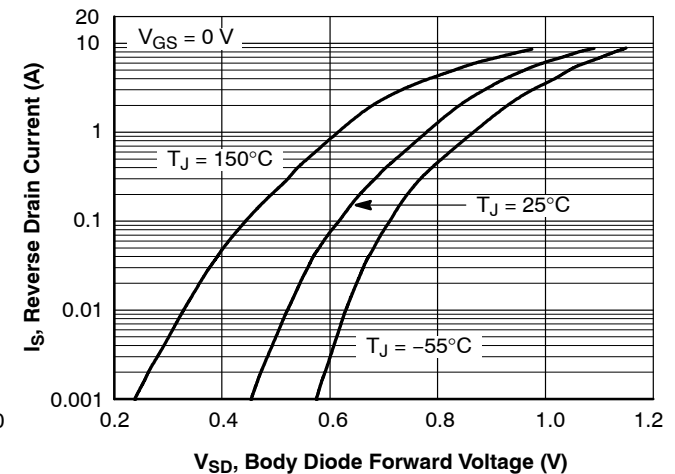

Figure 18. Source to Drain Diode Forward Voltage vs. Source Current

FDMC6890NZ

TYPICAL CHARACTERISTICS (Q2 N-CHANNEL) ($T_J = 25^\circ\text{C}$ unless otherwise noted) (continued)

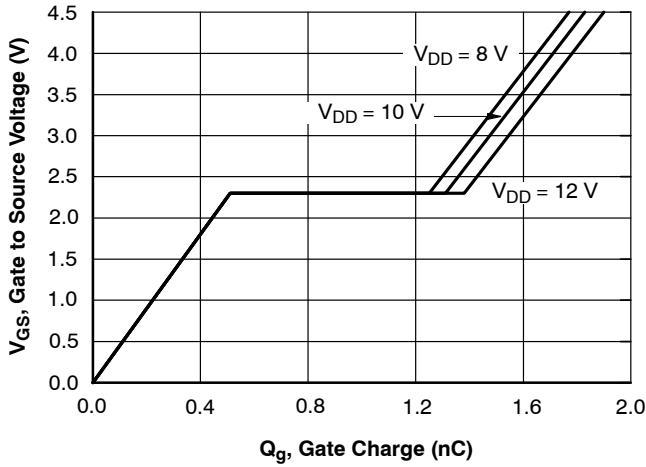

Figure 19. Gate Charge Characteristics

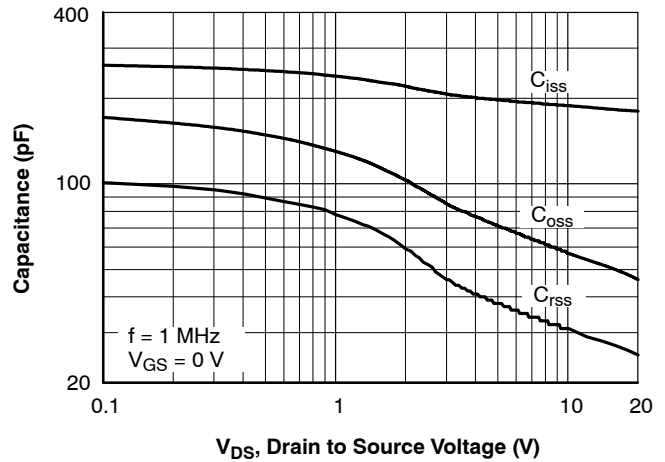

Figure 20. Capacitance vs. Drain to Source Voltage

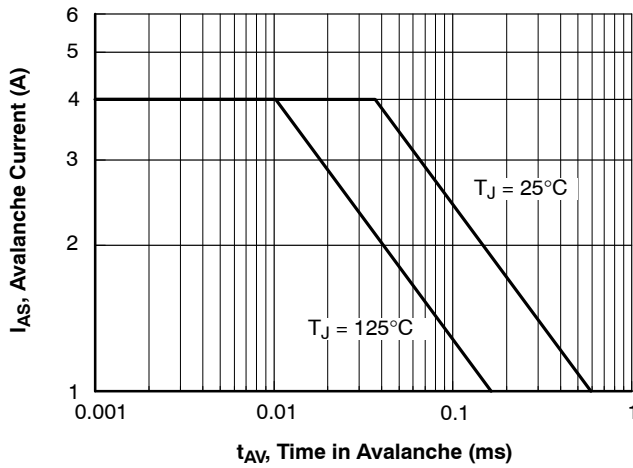

Figure 21. Unclamped Inductive Switching Capability

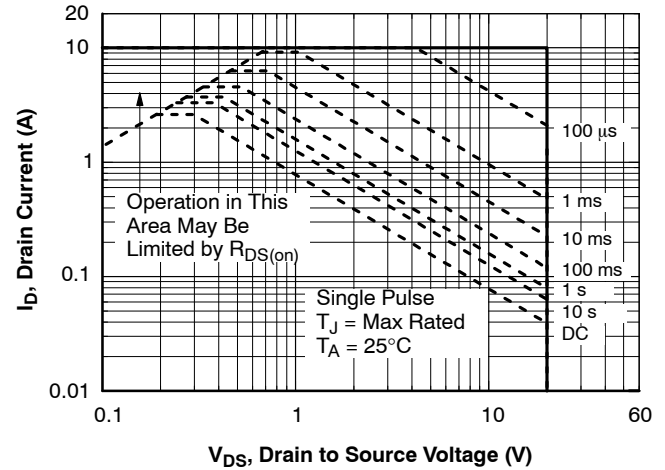

Figure 22. Forward Bias Safe Operating Area

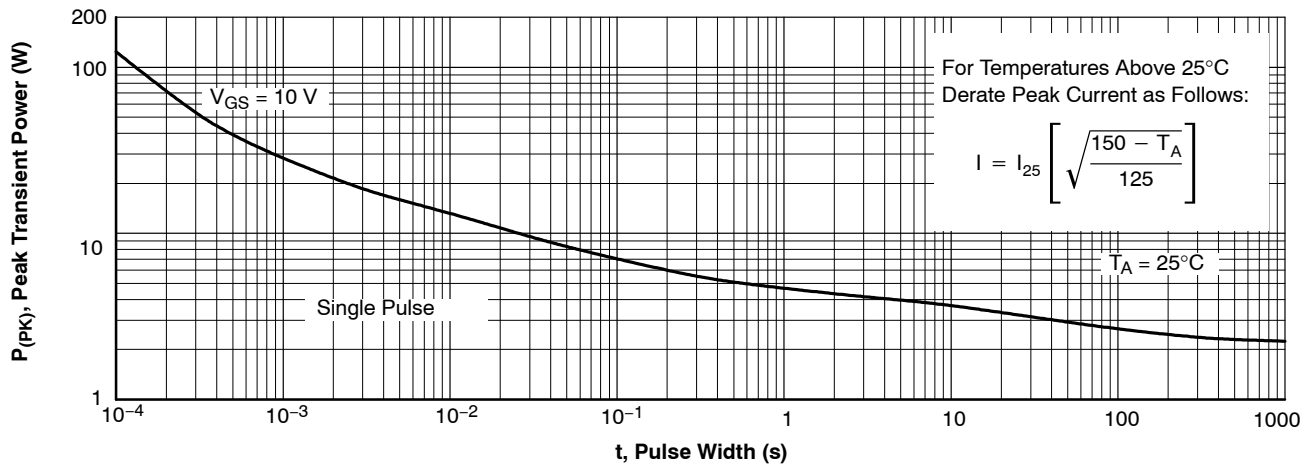

Figure 23. Single Pulse Maximum Power Dissipation

FDMC6890NZ

TYPICAL CHARACTERISTICS (Q2 N-CHANNEL) ($T_J = 25^\circ\text{C}$ unless otherwise noted) (continued)

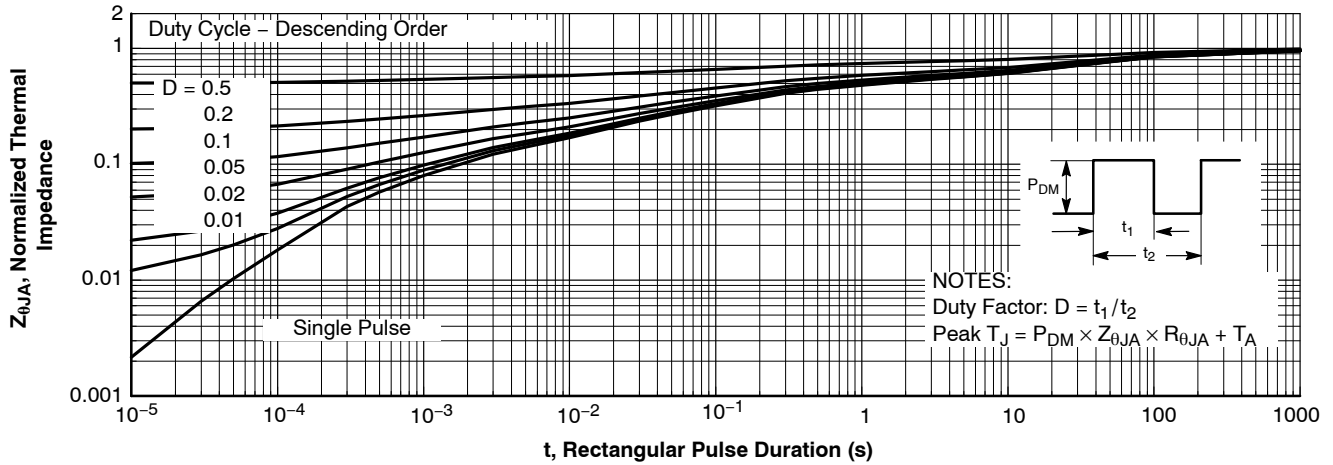

Figure 24. Transient Thermal Response Curve

PACKAGE MARKING AND ORDERING INFORMATION

Device	Device Marking	Package Type	Reel Size	Tape Width	Shipping [†]
FDMC6890NZ	6890N	WDFN6 3 x 3, 0.95P (Power 33) (Pb-Free/Halide Free)	7"	8 mm	3000 / Tape & Reel

[†]For information on tape and reel specifications, including part orientation and tape sizes, please refer to our Tape and Reel Packaging Specifications Brochure, [BRD8011/D](#).



WDFN6 3x3, 0.95P
CASE 511DT
ISSUE O

DATE 31 DEC 2016

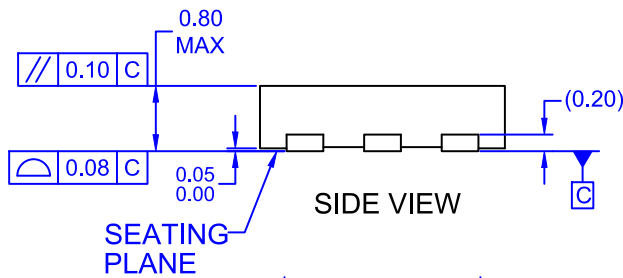
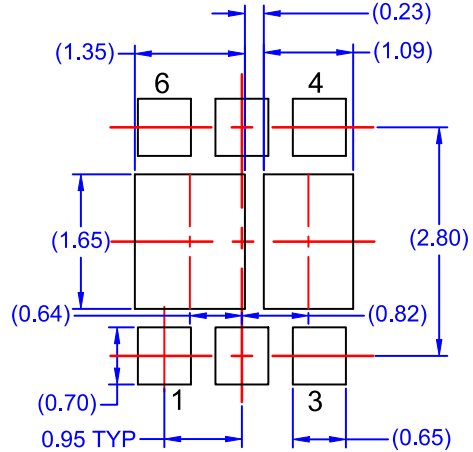
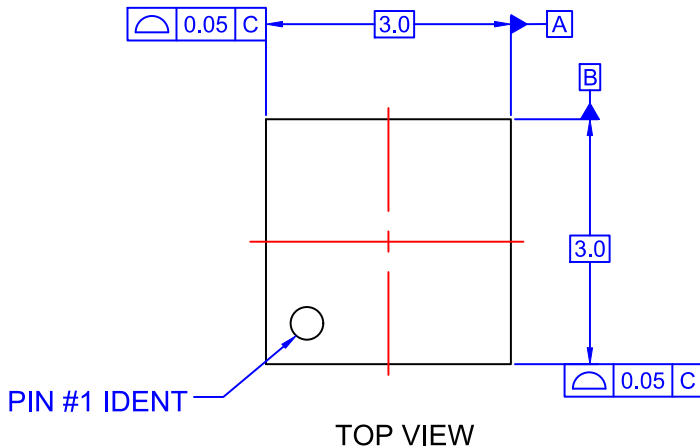

RECOMMENDED LAND PATTERN

- NOTES: UNLESS OTHERWISE SPECIFIED**
- A) CONFORMS TO JEDEC REGISTRATION, MO-229, VARIATION WEEA
 - B) ALL DIMENSIONS ARE IN MILLIMETERS.
 - C) DIMENSIONS DO NOT INCLUDE BURRS OR MOLD FLASH. MOLD FLASH OR BURRS DOES NOT EXCEED 0.10MM.
 - D) DIMENSIONING AND TOLERANCING PER ASME Y14.5M-2009.

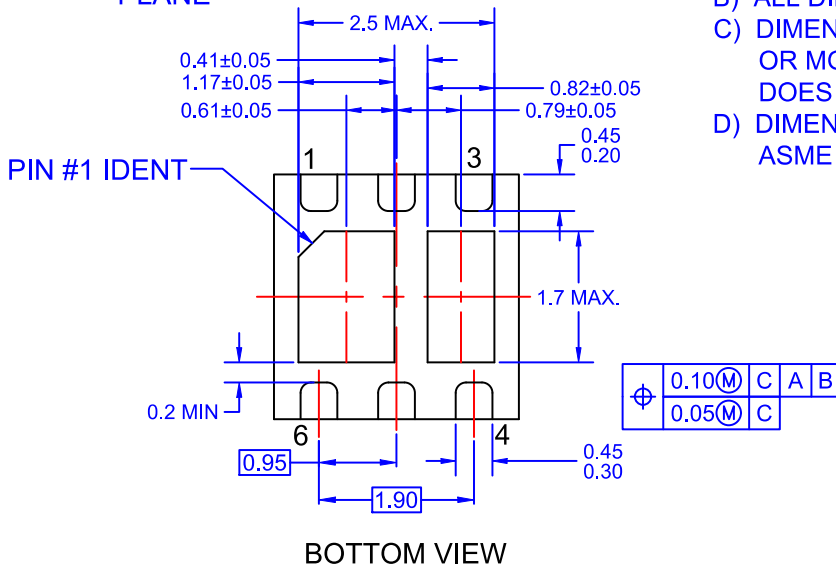

DOCUMENT NUMBER:	98AON13605G	Electronic versions are uncontrolled except when accessed directly from the Document Repository. Printed versions are uncontrolled except when stamped "CONTROLLED COPY" in red.
DESCRIPTION:	WDFN6 3x3, 0.95P	PAGE 1 OF 1

ON Semiconductor and are trademarks of Semiconductor Components Industries, LLC dba ON Semiconductor or its subsidiaries in the United States and/or other countries. ON Semiconductor reserves the right to make changes without further notice to any products herein. ON Semiconductor makes no warranty, representation or guarantee regarding the suitability of its products for any particular purpose, nor does ON Semiconductor assume any liability arising out of the application or use of any product or circuit, and specifically disclaims any and all liability, including without limitation special, consequential or incidental damages. ON Semiconductor does not convey any license under its patent rights nor the rights of others.

onsemi, **Onsemi**, and other names, marks, and brands are registered and/or common law trademarks of Semiconductor Components Industries, LLC dba "**onsemi**" or its affiliates and/or subsidiaries in the United States and/or other countries. **onsemi** owns the rights to a number of patents, trademarks, copyrights, trade secrets, and other intellectual property. A listing of **onsemi**'s product/patent coverage may be accessed at www.onsemi.com/site/pdf/Patent-Marking.pdf. **onsemi** reserves the right to make changes at any time to any products or information herein, without notice. The information herein is provided "as-is" and **onsemi** makes no warranty, representation or guarantee regarding the accuracy of the information, product features, availability, functionality, or suitability of its products for any particular purpose, nor does **onsemi** assume any liability arising out of the application or use of any product or circuit, and specifically disclaims any and all liability, including without limitation special, consequential or incidental damages. Buyer is responsible for its products and applications using **onsemi** products, including compliance with all laws, regulations and safety requirements or standards, regardless of any support or applications information provided by **onsemi**. "Typical" parameters which may be provided in **onsemi** data sheets and/or specifications can and do vary in different applications and actual performance may vary over time. All operating parameters, including "Typicals" must be validated for each customer application by customer's technical experts. **onsemi** does not convey any license under any of its intellectual property rights nor the rights of others. **onsemi** products are not designed, intended, or authorized for use as a critical component in life support systems or any FDA Class 3 medical devices or medical devices with a same or similar classification in a foreign jurisdiction or any devices intended for implantation in the human body. Should Buyer purchase or use **onsemi** products for any such unintended or unauthorized application, Buyer shall indemnify and hold **onsemi** and its officers, employees, subsidiaries, affiliates, and distributors harmless against all claims, costs, damages, and expenses, and reasonable attorney fees arising out of, directly or indirectly, any claim of personal injury or death associated with such unintended or unauthorized use, even if such claim alleges that **onsemi** was negligent regarding the design or manufacture of the part. **onsemi** is an Equal Opportunity/Affirmative Action Employer. This literature is subject to all applicable copyright laws and is not for resale in any manner.

ADDITIONAL INFORMATION

TECHNICAL PUBLICATIONS:

Technical Library: www.onsemi.com/design/resources/technical-documentation
onsemi Website: www.onsemi.com

ONLINE SUPPORT: www.onsemi.com/support

For additional information, please contact your local Sales Representative at www.onsemi.com/support/sales