

Revision Level			Revision Record	Changed	Date	Approved	Date
Drawing	State	Part					
00.2	Design Release	-	SEE ECN# 014774	TAT	12/3/2018	EJH	12/3/2018

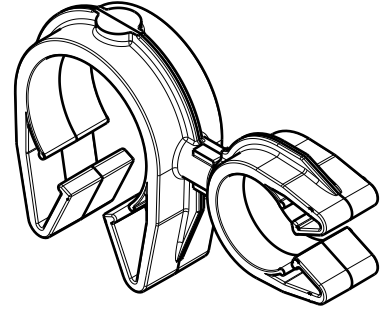

ISOMETRIC VIEW

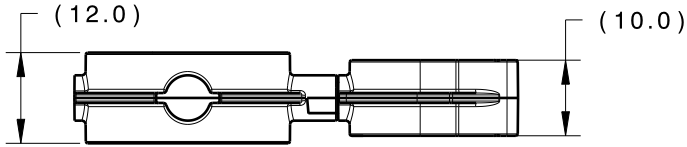
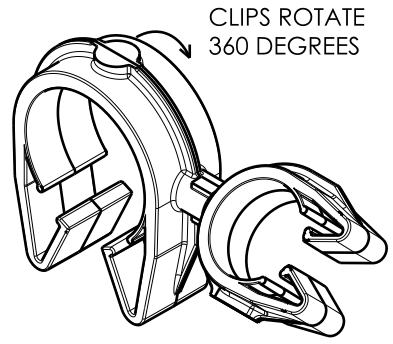
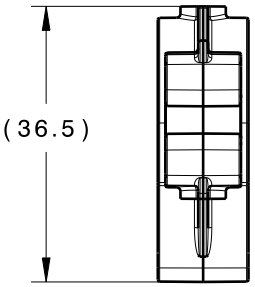
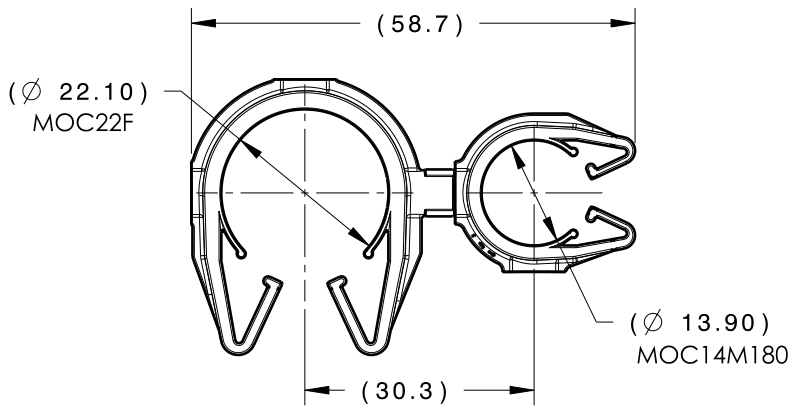

ISOMETRIC VIEW ROTATED

TYPE	MOC22F	MOC14M180
HARNESS	20.0MM - 24.0MM	13.0MM - 15.0MM
HOSE	20.0MM - 24.0MM	13.0MM - 15.0MM
HARD PIPE/TUBE	22.0MM - 25.0MM	14.0MM - 15.8MM

\*RECOMMENDED SIZES MAY DIFFER DEPENDING ON THE APPLICATION , PRODUCT REQUIREMENTS AND MATERIALS USED

\*\*PATENT PENDING 29/582,271

GLOBAL PART DESCRIPTION	MOC22F**			MOC14M180**		
	DRAWING	MATERIAL	COLOR	DRAWING	MATERIAL	COLOR
MOC22FMOC14M180-PA66HIRHSUV-BK	16-0323-000-CSU	PA66HIRHSUV	BLACK	16-0320-000-CSU	PA66HIRHSUV	BLACK

Material SEE CHART COLOR: SEE CHART	Units	millimeters	The copyright of this drawing is reserved by HellermannTyton. It is issued on condition that it is not reproduced, copied or disclosed to a third party, either wholly or in part, without the consent of HellermannTyton.	Drawn	CJR	10/1/18	Article/Type-No MOC22FMOC14M180	Scale	1:1	
	Tolerance defined on each dimension	Approved		TAT	10/1/18	Title 22MM MOC COUPLED TO A 14MM MOC M180		Project Number	16-0330	
		 North America Email: corp@htamericas.com Web: www.hellermann.tyton.com			Drawing-No		PRODUCTION : Phase	Format	AH	
					16-0330-742-CSU		Sheet	1/1		