

## High Voltage LED Series Chip on Board

# LCo26D – Gen.1



High efficacy COB LED package  
well-suited for use in spotlight applications

### Features & Benefits

- Chip on Board (COB) solution makes it easy to design in
- Simple assembly reduces manufacturing cost
- Low thermal resistance
- InGaN/GaN MQW LED with long time reliability

### Applications

- Spotlight / Downlight
- LED Retrofit Bulbs
- Outdoor Illumination



## Table of Contents

1.	Characteristics	-----	3
2.	Product Code Information	-----	5
3.	Typical Characteristics Graphs	-----	9
4.	Outline Drawing & Dimension	-----	12
5.	Reliability Test Items & Conditions	-----	13
6.	Label Structure	-----	14
7.	Packing Structure	-----	15
8.	Precautions in Handling & Use	-----	17

## 1. Characteristics

### a) Absolute Maximum Rating

Item	Symbol	Rating	Unit	Condition
Ambient / Operating Temperature	$T_a$	-40 ~ +105	°C	-
Storage Temperature	$T_{stg}$	-40 ~ +120	°C	-
LED Junction Temperature	$T_J$	140	°C	-
Case Temperature	$T_c$	105	°C	-
Forward Current	$I_F$	1840	mA	-
Power Dissipation	$P_D$	69	W	-
ESD (HBM)	-	±2	kV	-
ESD (MM)	-	±0.5	kV	-

### b) Electro-optical Characteristics ( $I_F = 720 \text{ mA}$ , $T_J = 85 \text{ °C}$ )

Item	Unit	Rank	Min.	Typ.	Max.
Forward Voltage ( $V_F$ )	V	YZ	31.8	34.6	37.5
Color Rendering Index ( $R_a$ )	-	5	80	-	-
		7	90	-	-
Thermal Resistance (junction to chip point)	°C/W		-	1.0	-
Beam Angle	°		-	115	-
Nominal Power	W			24.9	

#### Notes:

- 1) The COB is tested in pulsed condition at rated test current (10 ms pulse width) and rated temperature ( $T_J = T_C = T_a = 85 \text{ °C}$ )
- 2) Samsung maintains measurement tolerance of: forward voltage = ±5 %, CRI = ±1
- 3) Refer to the derating curve, '3. Typical Characteristics Graph' designed within the range.

### c) Luminous Flux Characteristics ( $I_F = 720 \text{ mA}$ )

CRI ( $R_a$ ) Min.	Nominal CCT (K)	Flux Rank	Flux @ $T_c = 85 \text{ }^\circ\text{C}$ (lm)		
			Min.	Typ.	Max.
80	2700	K0	3064	3225	-
		D1	3225	3386	-
	3000	K2	3220	3389	-
		D1	3389	3558	-
	3500	K3	3314	3488	-
		D1	3488	3663	-
	4000	K3	3380	3558	-
		D1	3558	3736	-
	5000	K4	3409	3588	-
		D1	3588	3767	-
	5700	K4	3409	3588	-
		D1	3588	3767	-
	6500	K3	3380	3558	-
		D1	3558	3736	-

CRI ( $R_a$ ) Min.	Nominal CCT (K)	Flux Rank	Flux @ $T_c = 85 \text{ }^\circ\text{C}$ (lm)		
			Min.	Typ.	Max.
90	2700	J6	2622	2760	-
		D1	2760	2898	-
	3000	J7	2758	2903	-
		D1	2903	3048	-
	3500	J8	2840	2990	-
		D1	2990	3139	-
	4000	J8	2899	3051	-
		D1	3051	3204	-
	5000	J8	2923	3077	-
		D1	3077	3231	-

#### Notes:

- 1) The COB is tested in pulsed operating condition at rated test current (10 ms pulse width) and rated temperature ( $T_J = T_C = 85 \text{ }^\circ\text{C}$ ).
- 2) Samsung maintains measurement tolerance of: Luminous flux =  $\pm 7 \%$ , CRI =  $\pm 1$

## 2. Product Code Information

1	2	3	4	5	6	7	8	9	10	11	12	13	14	15	16	17	18
S	P	H	W	H	A	H	D	N	G	2	5	Y	Z	W	3	K	0

Digit	PKG Information	Code	Specification
1 2 3	Samsung Package High Power	<b>SPH</b>	
4 5	Color	<b>WH</b>	White
6	Product Version	<b>A</b>	
7 8	Form Factor	<b>HD</b>	COB
9	Lens Type	<b>N</b>	No lens
10	Wattage or Model	<b>G</b>	LC026D
11	Internal Code	<b>2</b>	
12	CRI & Sorting Temperature	<b>5</b> <b>7</b>	Min. 80 (85°C) Min. 90 (85°C)
13 14	Forward Voltage (V)	<b>YZ</b>	31.8~37.5
15	CCT (K)	<b>W</b> <b>V</b> <b>U</b> <b>T</b> <b>R</b> <b>Q</b> <b>P</b>	2700K 3000K 3500K 4000K 5000K 5700K 6500K
16	MacAdam Step	<b>2</b> <b>3</b>	MacAdam 2-step MacAdam 3-step
17 18	Luminous Flux	<b>J6</b> <b>J7</b> <b>J8</b> <b>K0</b> <b>K2</b> <b>K3</b> <b>K4</b> <b>D1</b>	Min. 2600 Min. 2700 Min. 2800 Min. 3000 Min.3200 Min. 3300 Min. 3400 Add rank

a) Binning Structure ( $I_F = 720 \text{ mA}$ ,  $T_J = 85 \text{ }^\circ\text{C}$ )

CRI ( $R_a$ ) Min.	Nominal CCT (K)	Product Code	$V_F$ Rank	Color Rank	Flux Rank	Flux Range ( $\Phi_v$ , lm)
80	2700	SPHWAHDNG25YZW2K0	YZ	W2	K0	3064 ~
		SPHWAHDNG25YZW3K0		W3		
		SPHWAHDNG25YZW2D1		W2	D1	3225 ~
		SPHWAHDNG25YZW3D1		W3		
	3000	SPHWAHDNG25YZV2K2	YZ	V2	K2	3220 ~
		SPHWAHDNG25YZV3K2		V3		
		SPHWAHDNG25YZV2D1		V2	D1	3389~
		SPHWAHDNG25YZV3D1		V3		
	3500	SPHWAHDNG25YZU2K3	YZ	U2	K3	3314 ~
		SPHWAHDNG25YZU3K3		U3		
		SPHWAHDNG25YZU2D1		U2	D1	3488 ~
		SPHWAHDNG25YZU3D1		U3		
	4000	SPHWAHDNG25YZT2K3	YZ	T2	K3	3380 ~
		SPHWAHDNG25YZT3K3		T3		
		SPHWAHDNG25YZT2D1		T2	D1	3588 ~
		SPHWAHDNG25YZT3D1		T3		
	5000	SPHWAHDNG25YZR3K4	YZ	R3	K4	3409 ~
		SPHWAHDNG25YZR3D1			D1	3588 ~
	5700	SPHWAHDNG25YZQ3K4	YZ	Q3	K4	3409 ~
		SPHWAHDNG25YZQ3D1			D1	3588 ~
6500	SPHWAHDNG25YZP3K3	YZ	P3	K3	3380 ~	
	SPHWAHDNG25YZP3D1			D1	3558 ~	

CRI (R <sub>a</sub> ) Min.	Nominal CCT (K)	Product Code	V <sub>F</sub> Rank	Color Rank	Flux Rank	Flux Range (Φ <sub>v</sub> , lm)
90	2700	SPHWAHDNG27YZW2J6	YZ	W2	J6	2622 ~
		SPHWAHDNG27YZW3J6		W3		
		SPHWAHDNG27YZW2D1		W2	D1	2760 ~
		SPHWAHDNG27YZW3D1		W3		
	3000	SPHWAHDNG27YZV2J7	YZ	V2	J7	2758 ~
		SPHWAHDNG27YZV3J7		V3		
		SPHWAHDNG27YZV2D1		V2	D1	2903 ~
		SPHWAHDNG27YZV3D1		V3		
	3500	SPHWAHDNG27YZU2J8	YZ	U2	J8	2840 ~
		SPHWAHDNG27YZU3J8		U3		
		SPHWAHDNG27YZU2D1		U2	D1	2990 ~
		SPHWAHDNG27YZU3D1		U3		
	4000	SPHWAHDNG27YZT2J8	YZ	T2	J8	2899 ~
		SPHWAHDNG27YZT3J8		T3		
		SPHWAHDNG27YZT2D1		T2	D1	3051 ~
		SPHWAHDNG27YZT3D1		T3		
	5000	SPHWAHDNG27YZR3J8	YZ	R3	J8	2923 ~
		SPHWAHDNG27YZR3D1		R3	D1	3077 ~

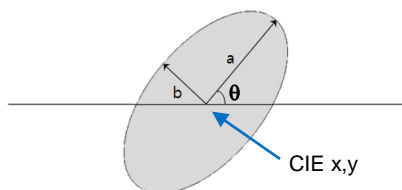
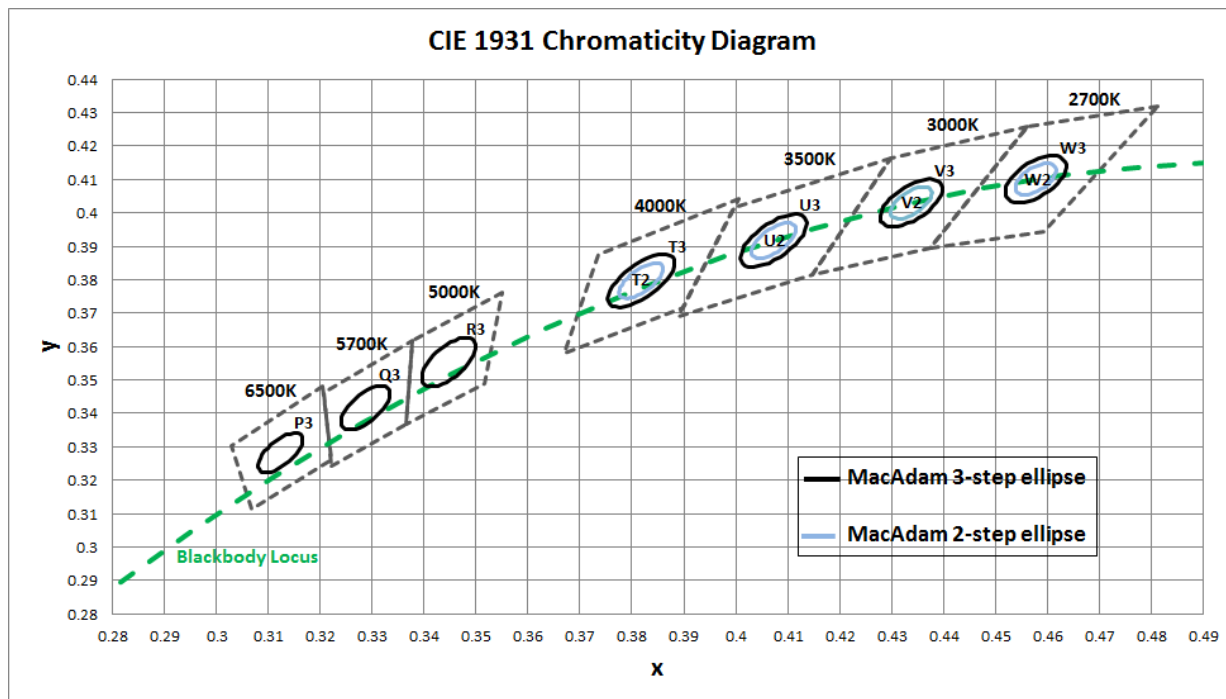
b) Chromaticity Region & Coordinates ( $I_F = 720 \text{ mA}$ ,  $T_J = 85 \text{ }^\circ\text{C}$ )

MacAdam Ellipse (W2, W3)					
Step	CIE x	CIE y	$\theta$	a	b
2-step	0.4578	0.4101	53.70	0.0054	0.0028
3-step	0.4578	0.4101	53.70	0.0081	0.0042

MacAdam Ellipse (V2, V3)					
Step	CIE x	CIE y	$\theta$	a	b
2-step	0.4338	0.403	53.22	0.0056	0.0027
3-step	0.4338	0.4030	53.22	0.0083	0.0041

MacAdam Ellipse (U2, U3)					
Step	CIE x	CIE y	$\theta$	a	b
2-step	0.4073	0.3917	54.00	0.0062	0.0028
3-step	0.4073	0.3917	54.00	0.0093	0.0041

MacAdam Ellipse (T2, T3)					
Step	CIE x	CIE y	$\theta$	a	b
2-step	0.3818	0.3797	53.72	0.0063	0.0027
3-step	0.3818	0.3797	53.72	0.0094	0.0040

MacAdam Ellipse (R3)					
Step	CIE x	CIE y	$\theta$	a	b
3-step	0.3447	0.3553	59.62	0.0082	0.0035

MacAdam Ellipse (Q3)					
Step	CIE x	CIE y	$\theta$	a	b
3-step	0.3287	0.3417	59.0950	0.0075	0.0032

MacAdam Ellipse (P3)					
Step	CIE x	CIE y	$\theta$	a	b
3-step	0.3123	0.3282	58.5700	0.0067	0.0029

**Note:**

Samsung maintains measurement tolerance of:  $C_x, C_y = \pm 0.005$



### 3. Typical Characteristics Graphs

#### a) Spectrum Distribution ( $I_f = 720 \text{ mA}$ , $T_J = 85 \text{ }^\circ\text{C}$ )

CCT: 2700 K (80 CRI)

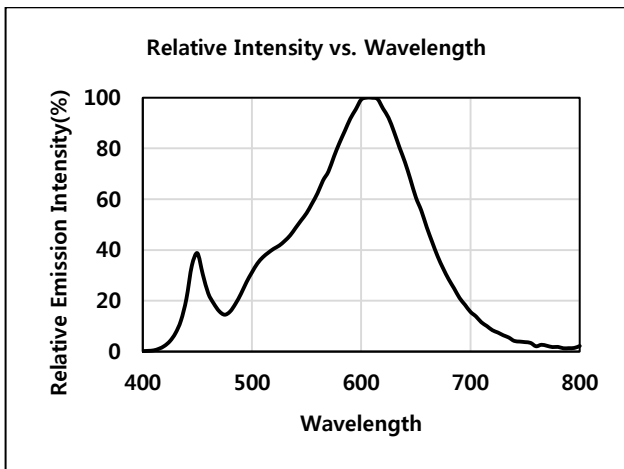

CCT: 3000 K (80 CRI)

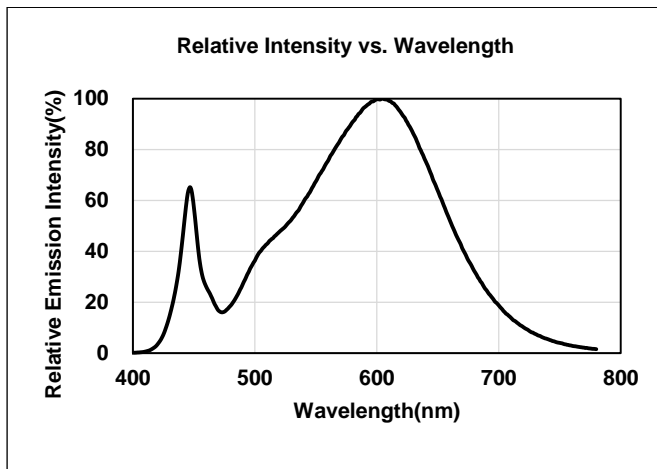

CCT: 3500 K (80 CRI)

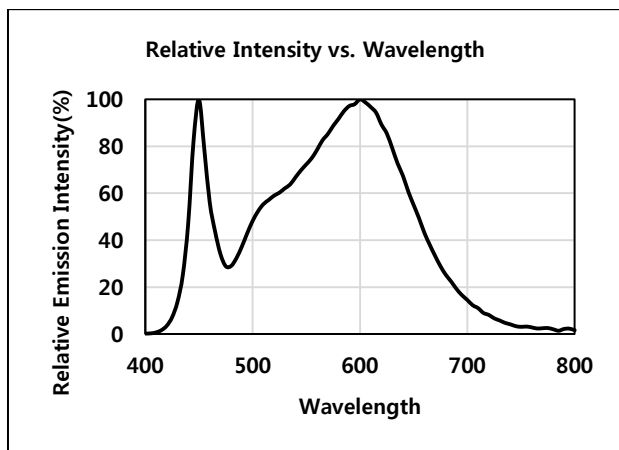

CCT: 4000 K (80 CRI)

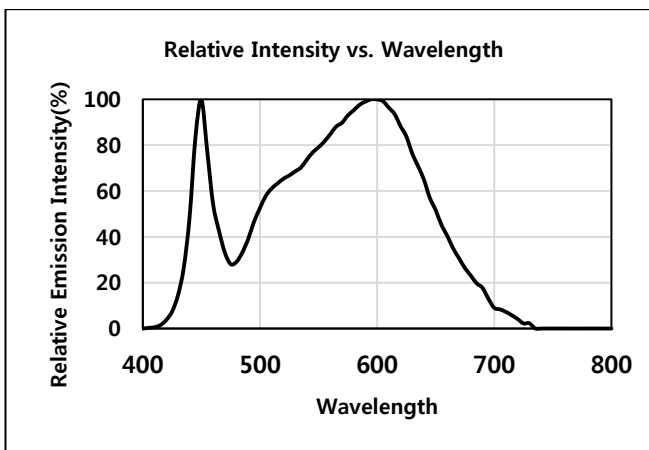

CCT: 5000 K (80 CRI)

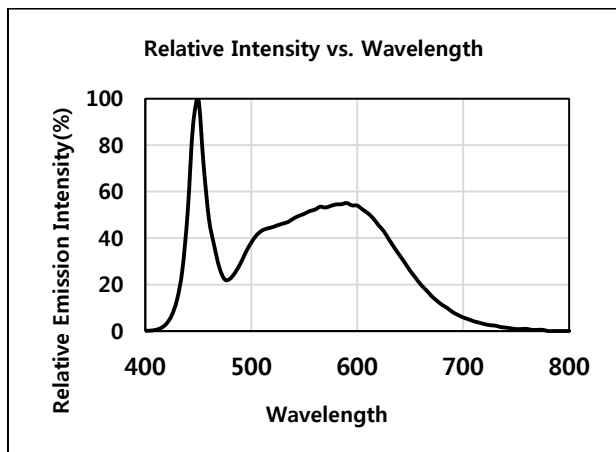

CCT: 5700 K (80 CRI)

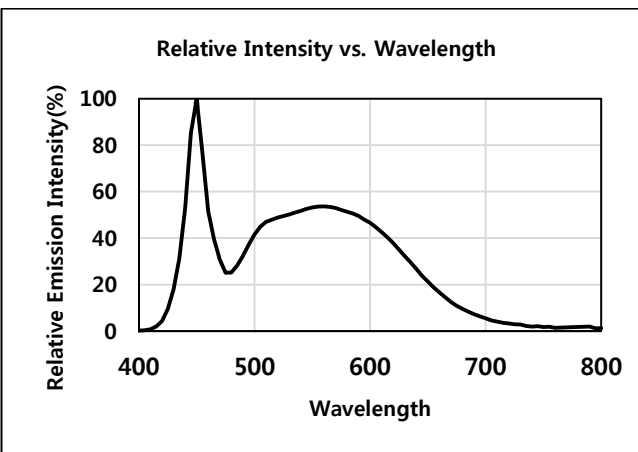

CCT: 6500 K (80 CRI)

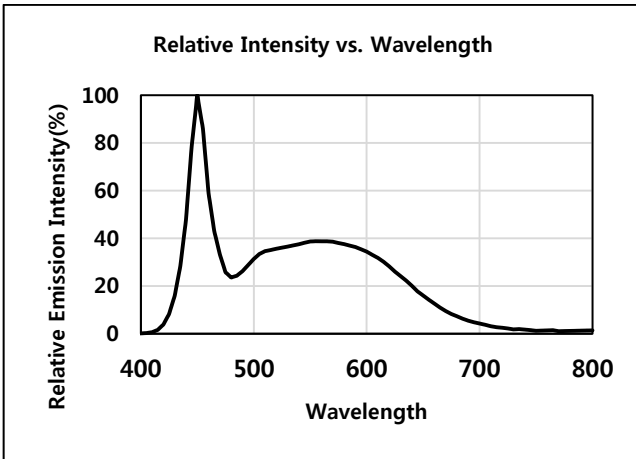

### b) Forward Current Characteristics ( $T_j = 85^\circ\text{C}$ )

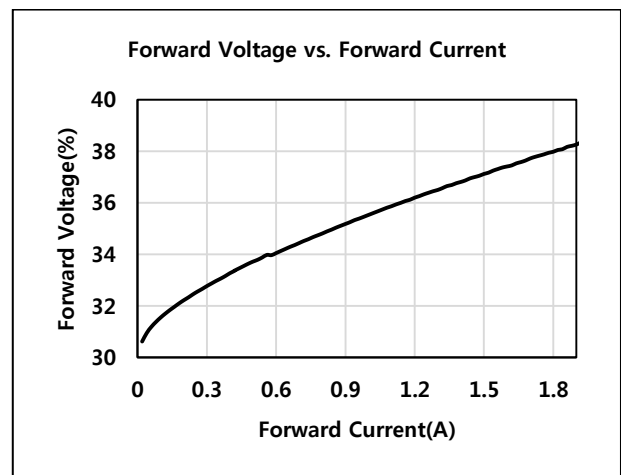
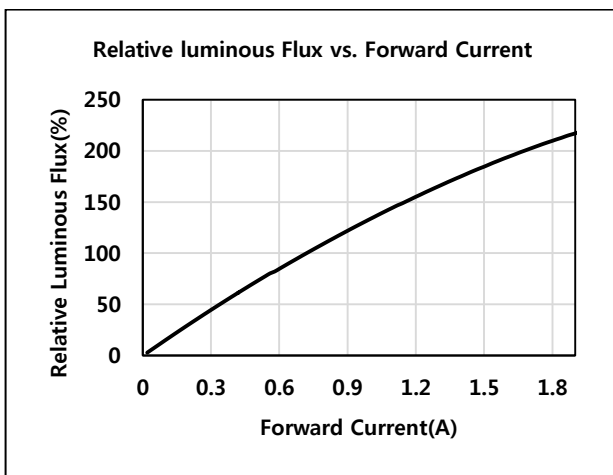

### C) Temperature Characteristics ( $I_F = 720\text{mA}$ )

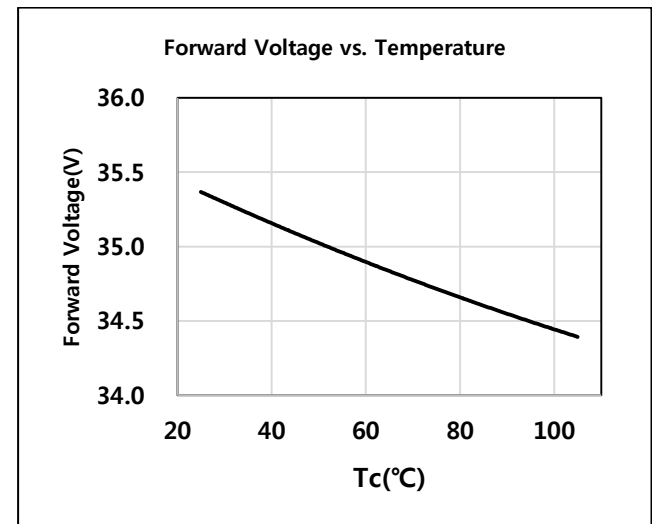
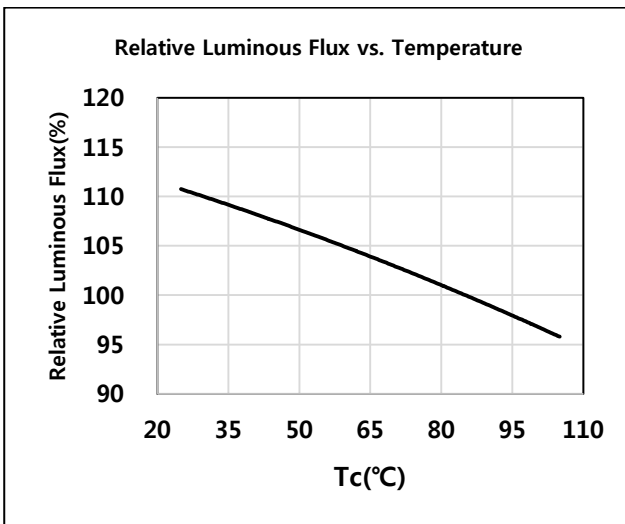

d) Color Shift Characteristics ( $T_J = 85\text{ }^\circ\text{C}$ ,  $I_F = 720\text{mA}$ , CRI80+)

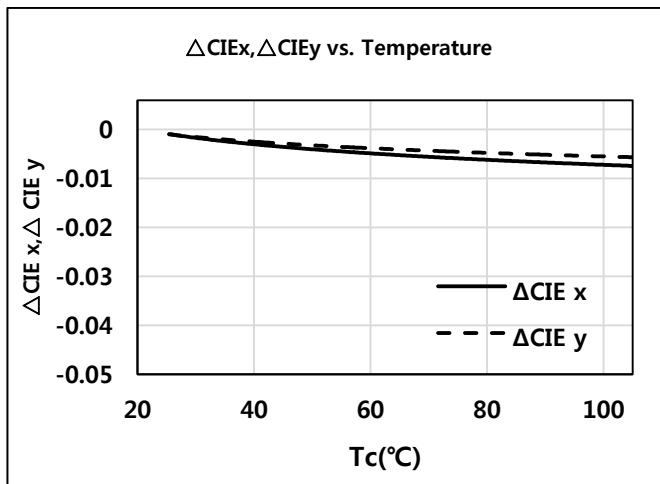
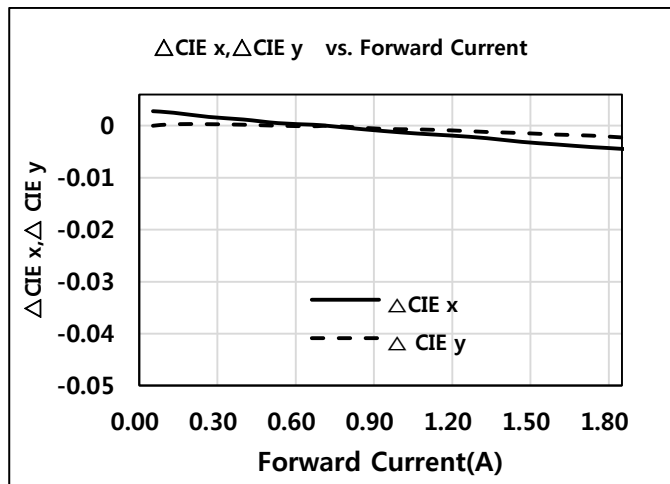

e) Beam Angle Characteristics ( $I_F = 720\text{ mA}$ ,  $T_J = 85\text{ }^\circ\text{C}$ )

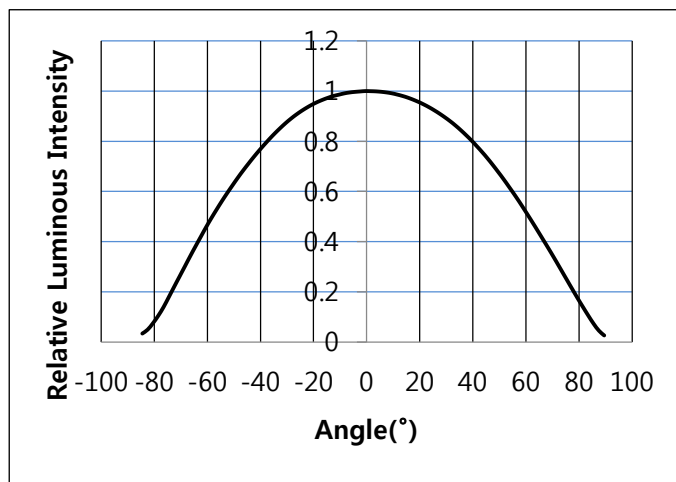

f) Derating Characteristics

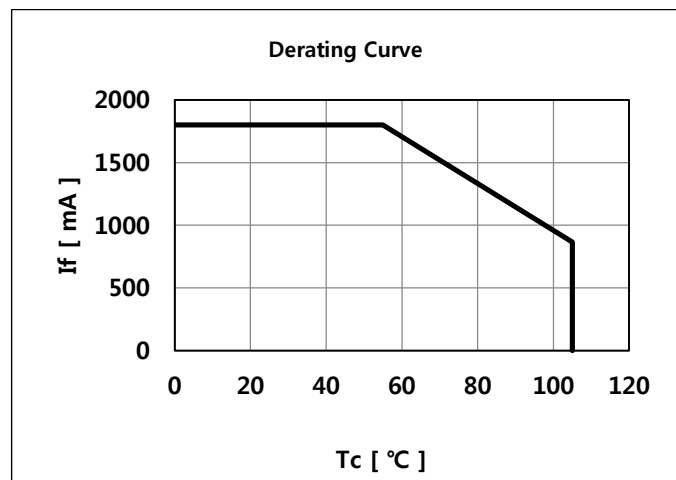

#### 4. Outline Drawing & Dimension

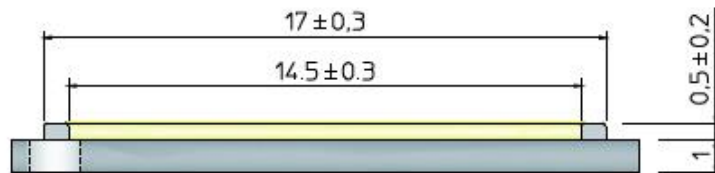
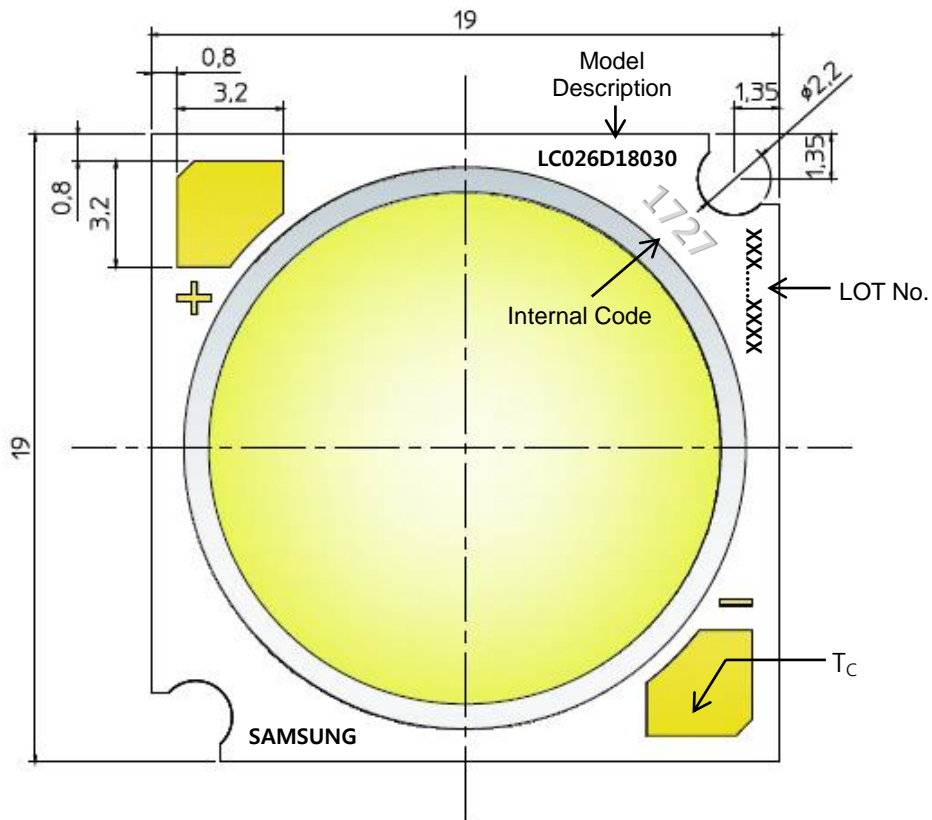

- 1. Unit: mm
- 2. Tolerance: ± 0.3 mm

Item	Dimension	Tolerance	Unit
Length	19.0	±0.15	mm
Width	19.0	±0.15	mm
Height	1.50	±0.30	mm
Light Emitting Surface (LES) Diameter	14.5	±0.30	mm

Note: Denoted product information above is only an example  
 ( LC026D18030 : LC026D, CRI80+, 3000K )

## 5. Reliability Test Items & Conditions

### a) Test Items

Test Item	Test Condition	Test Hour / Cycle
High Temperature Humidity Life Test	60 °C, 90 % RH,, DC Derating, $I_F$	1000 h
High Temperature Life Test	85 °C, DC Derating, $I_F$	1000 h
Low Temperature Life Test	-40 °C, DC , $I_F = 1290$ mA	1000 h
Pulsed Operating Life Test	55 °C, Pulse width 100 $\mu$ s, duty cycle 3 %	1000 h
High Temperature Storage	120 °C	1000 h
Low Temperature Storage	-40 °C	1000 h
Temperature Humidity Storage	60 °C, 90% RH	1000h
Thermal Cycle	-45 °C / 15 min $\leftrightarrow$ 125 °C / 15 min temperature change in 5 min	500 cycles
Temperature Cycle On/Off Test	-40 °C / 85 °C each 20 min, 30 min transfer power on/off each 5 min, DC Derating, $I_F = \text{max}$	100 cycles
ESD (HBM)	$R_1$ : 10 M $\Omega$ $R_2$ : 1.5 k $\Omega$ C: 100 pF V: $\pm 2$ kV	5 times
ESD (MM)	$R_1$ : 10 M $\Omega$ $R_2$ : 0 k $\Omega$ C: 200 pF V: $\pm 0.2$ kV	5 times
Vibration Test	20 ~ 80 Hz (displacement: 0.06 inch, max. 20 g) 80 ~ 2 kHz (max. 20 g) min. frequency $\leftrightarrow$ max. frequency 4 min transfer	4 times
Mechanical Shock Test	1500 g, 0.5 ms each of the 6 surfaces (3 axis x 2 sides)	5 times
Sulfur Resistance	25 °C, 75%, H2S 15 ppm	504h

### b) Criteria for Judging the Damage

Item	Symbol	Test Condition ( $T_c = 25$ °C)	Limit	
			Min.	Max.
Forward Voltage	$V_F$	$I_F = 720$ mA	L.S.L. * 0.9	U.S.L. * 1.1
Luminous Flux	$\Phi_v$	$I_F = 720$ mA	L.S.L * 0.7	U.S.L * 1.3

## 6. Label Structure

### a) Label Structure

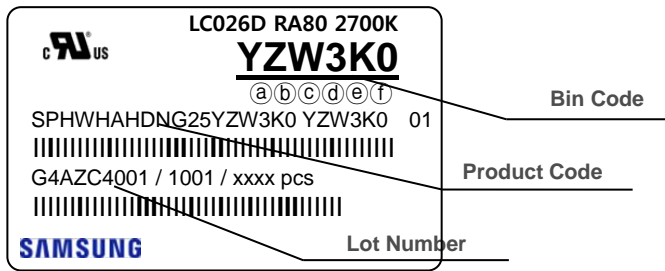

Note: Denoted bin code and product code above is only an example (see description on page 5)

Bin Code:

- ⒶⒷ: Forward Voltage bin (refer to page 11)
- ⒸⒹ: Chromaticity bin (refer to page 9-10)
- ⒺⒻ: Luminous Flux bin (refer to page 6)

### b) Lot Number

The lot number is composed of the following characters:

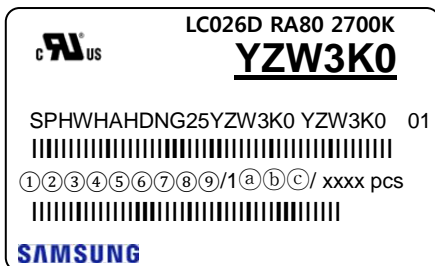

① ③④⑤⑥⑦⑧⑨ / 1ⒶⒷⒸ / xxxx pcs

- ① : Production site (S: Giheung, Korea, G: Tianjin, China)
- ② : 4 (LED)
- ③ : Product state (A: Normal, B: Bulk, C: First Production, R: Reproduction, S: Sample)
- ④ : Year (Z: 2015, A: 2016, B: 2017...)
- ⑤ : Month (1~9, A, B, C)
- ⑥⑦⑧⑨ : Day (1~9, A, B~V)
- ⒶⒷⒸ : Product serial number (001 ~ 999)

## 7. Packing Structure

Packing material	Max. quantity in pcs of COB	Dimension(mm)			
		Length	Width	Height	Tolerance
<b>Tray</b>	20	160	180	10	1.0
<b>Aluminum Bag</b>	40(2 trays)	210	241		10
<b>Inner Box</b>	160	230	84	260	2
<b>Outer Box</b>	1600	476	445	272	5

### a) Packing Structure

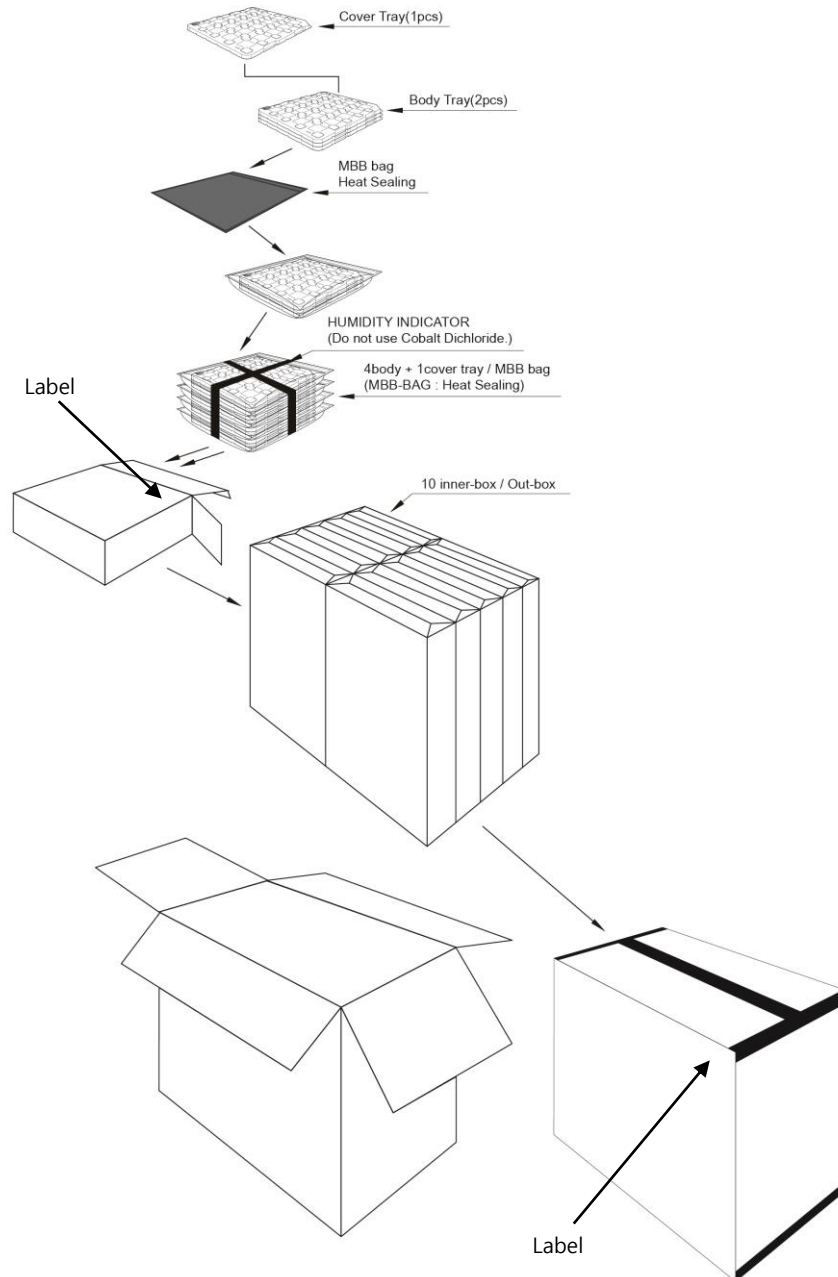

b) Tray

① Cover

② Body

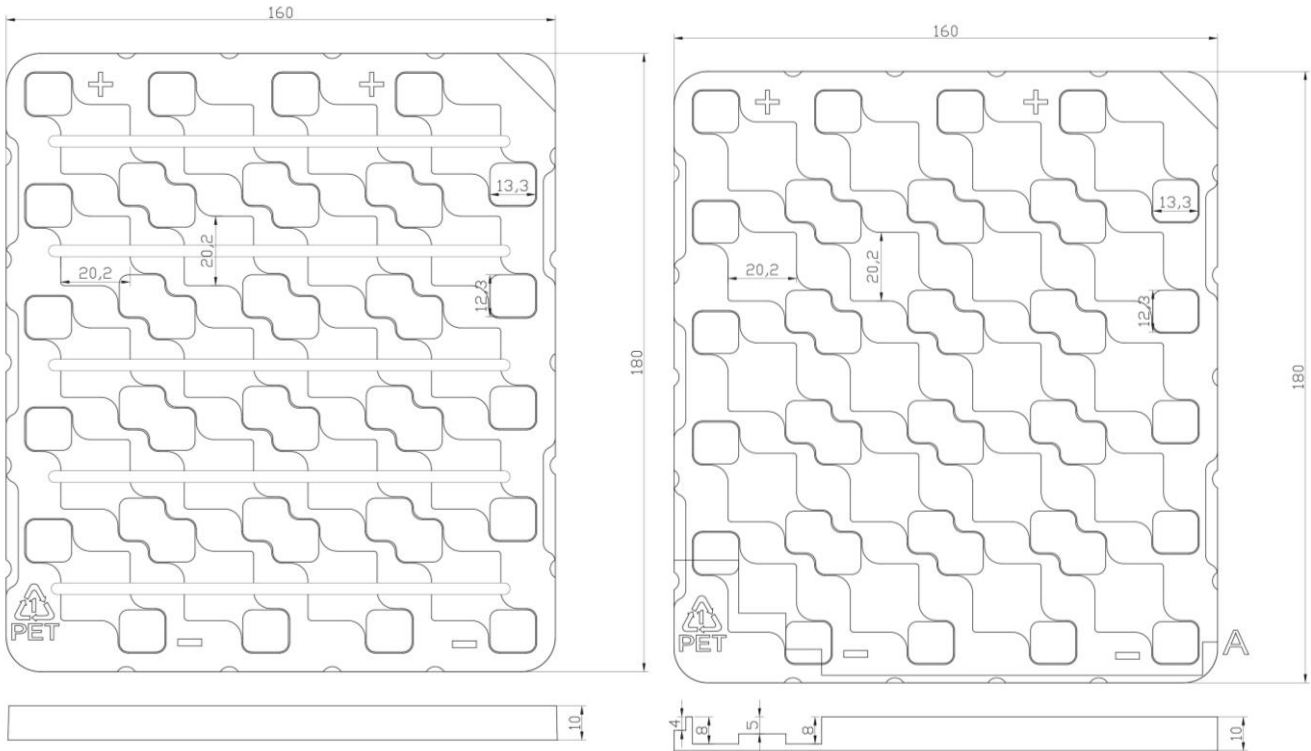

c) Aluminum Vinyl Packing Bag

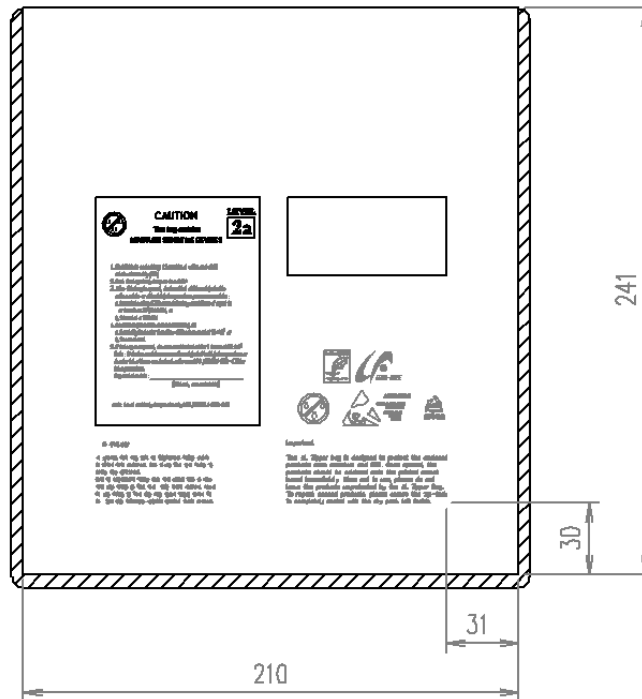



## 8. Precautions in Handling & Use

- 1) This device should not be used in any type of fluid such as water, oil, organic solvent, etc. When cleaning is required, IPA is recommended as the cleaning agent. Some solvent-based cleaning agent may damage the silicone resins used in the device.
- 2) LEDs must be stored in a clean environment. If the LEDs are to be stored for three months or more after being shipped from Samsung, they should be packed with a nitrogen-filled container (shelf life of sealed bags is 12 months at temperature 0~40 °C, 0~90 % RH).
- 3) After storage bag is opened, device subjected to soldering, solder reflow, or other high temperature processes must be:
  - a. Mounted within 672 hours (28 days) at an assembly line with a condition of no more than 30 °C / 60 % RH, or
  - b. Stored at <10 % RH
- 4) Repack unused products with anti-moisture packing, fold to close any opening and then store in a dry place.
- 5) Devices require baking before mounting, if humidity card reading is >60 % at 23 ± 5 °C.
- 6) Devices must be baked for 1 hour at 60 ± 5 °C, if baking is required.
- 7) The LEDs are sensitive to the static electricity and surge current. It is recommended to use a wrist band or anti-electrostatic glove when handling the LEDs. If voltage exceeding the absolute maximum rating is applied to LEDs, it may cause damage or even destruction to LED devices. Damaged LEDs may show some unusual characteristics such as increase in leakage current, lowered turn-on voltage, or abnormal lighting of LEDs at low current.
- 8) The thermal management is one of the most critical factors for the LED lighting system. Especially the LED junction temperature should not exceed the absolute maximum rating while operation of LED lighting system.  
For more information, please refer to Application Note 'Mechanical & Thermal Guide for COB'.
- 9) In case of driving LEDs around the minimum current level ( $I_{f\_min}$ ), chips might exhibit different brightness due to the variation in I-V characteristics of each one. This is normal and does not adversely affect the performance of product.
- 10) VOCs (Volatile Organic Compounds) can be generated from adhesives, flux, hardener or organic additives used in luminaires (fixtures). Transparent LED silicone encapsulant is permeable to those chemicals and they may lead to a discoloration of encapsulant when they exposed to heat or light. This phenomenon can cause a significant loss of light emitted (output) from the luminaires. In order to prevent these problems, we recommend users to know the physical properties of materials used in luminaires and they must be carefully selected.
- 11) The resin area is very sensitive, please do not handle, press, touch, rub, clean, or pick by with tweezers on it. Instead, please pick at the handling area as indicated below.

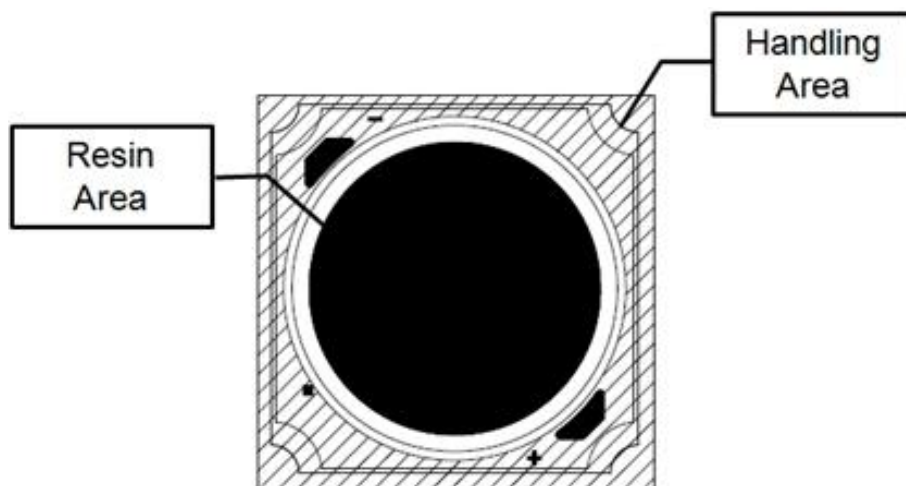

# Legal and additional information.

## [About Samsung Electronics Co., Ltd.](#)

Samsung Electronics Co., Ltd. inspires the world and shapes the future with transformative ideas and technologies, redefining the worlds of TVs, smartphones, wearable devices, tablets, cameras, digital appliances, printers, medical equipment, network systems and semiconductors.

We are also leading in the Internet of Things space through, among others, our Digital Health and Smart Home initiatives. We employ 307,000 people across 84 countries. To discover more, please visit our official website at [www.samsung.com](http://www.samsung.com) and our official blog at [global.samsungtomorrow.com](http://global.samsungtomorrow.com).

Copyright © 2015 Samsung Electronics Co., Ltd. All rights reserved.

Samsung is a registered trademark of Samsung Electronics Co., Ltd.

Specifications and designs are subject to change without notice. Non-metric weights and measurements are approximate. All data were deemed correct at time of creation. Samsung is not liable for errors or omissions. All brand, product, service names and logos are trademarks and/or registered trademarks of their respective owners and are hereby recognized and acknowledged.

Samsung Electronics Co., Ltd.  
95, Samsung 2-ro  
Giheung-gu  
Yongin-si, Gyeonggi-do, 446-711  
KOREA

[www.samsungled.com](http://www.samsungled.com)

**SAMSUNG**