



LMO78_1.0 series

Wide Input Non-Isolated & Regulated, Single Positive/Negative Output

Switching Regulator

- ⊕ High efficiency up to 96%
- ⊕ Operating temperature range: -40°C ~ +85°C
- ⊕ Short circuit protection (SCP)
- ⊕ Open frame SIP package
- ⊕ No-load input current as low as 0.1mA
- ⊕ Meets UL60950, EN60950 standards

The LMO78_1.0 series is a high efficiency switching regulator and ideal substitute for the LM78xx series three-terminal linear regulators. The product is featured with high efficiency, low loss, short circuit protection and no heat sink is required. They are widely used in industrial control, instrumentation, and electric power applications.



UL-60950-1 (E347551)

Common specifications	
Short circuit protection:	Continuous, automatic recovery
No-load input current:	0.1mA TYP, 1mA MAX
Reverse Polarity Input:	Forbidden
Input Filter:	Capacitor Filter
Cooling:	Free air convection
Operation temperature range:	-40°C~+85°C Power derating above 71°C
Storage temperature range:	-55°C ~+125°C
Pin welding resistance temperature:	260°C MAX, 1.5mm from case for 10 sec
Storage humidity range:	< 95%RH
Package material:	Plastic [UL94-V0]
MTBF:	>2,000,000 hours +25°C MIL-HDBK-217F
Weight:	2.1g

Output specifications						
Item	Test conditions	Min	Typ	Max	Units	
Output voltage accuracy	100% load • LMO78_03-0.5 • Others		±2	±4	%	
			±2	±3	%	
Line regulation	Input Voltage Range		±0.2	±0.4	%	
Load regulation	10% to 100% load		±0.4	±0.6	%	
Ripple + Noise*	20MHz Bandwidth Vin=24VDC 0% -100% load		20	75	mVp-p	
Switching frequency	Full load, nom. input • LMO78_03-1.0/ LMO78_05-1.0 • Others		420	520	620	KHz
			580	680	780	KHz
Transient response deviation	Nominal input, 25% load step change		50	300	mV	
Transient recovery time	Nominal input, 25% load step change		0.1	1	ms	
Temperature coefficient	-40 °C to +85 °C ambient			0.03	%/°C	

Note:

- The max. capacitive load should be tested within the input voltage range and under full load conditions;
- Without any special statement, all indexes are only specific to positive output application;
- Unless otherwise specified, data in this datasheet should be tested under the conditions of Ta = 25°C, humidity <75% when inputting nominal voltage and outputting rated load;
- All index testing methods in this datasheet are based on our Company's corporate standards;
- The performance indexes of the product models listed in this manual are as above, but some indexes of non-standard model products will exceed the above-mentioned requirements, and please directly contact with our technician for specific information;
- Specifications subject to change without prior notice.

* Test ripple and noise by "parallel cable" method. With the load lower than 20%, the maximum ripple and noise of 3.3V/5V output products will be 100mVp-p, 12V/15V output products will be 2%Vo.

Example:

LMO78_05-1.0
LM = Series; S = SIP Case; 05 = 5Vout; 1.0 = 1.0A

EMC specifications				
EMI	CE	CISPR22/EN55022	CLASS B	(External circuit refer to EMC recommended circuit,②) or EMC module application circuit)
EMI	RE	CISPR22/EN55022	CLASS B	(External circuit refer to EMC recommended circuit,②) or EMC module application circuit)
EMS	ESD	IEC/EN61000-4-2	Contact ±4KV	perf. Criteria B
EMS	RS	IEC/EN61000-4-3	10V/m	perf. Criteria A
EMS	EFT	IEC/EN61000-4-4	±1KV	perf. Criteria B (External circuit refer to EMC recommended circuit,①)
EMS	Surge	IEC/EN61000-4-5	line to line ±1KV	perf. Criteria B (External circuit refer to EMC recommended circuit,①)
EMS	CS	IEC/EN61000-4-6	3 Vr.m.s	perf. Criteria A

LMO78_1.0 series

Wide Input Non-Isolated & Regulated, Single Positive/Negative Output

Product Selection Guide

Part Number	Input Voltage [VDC] Nominal (Range)	Output Voltage [VDC]	Output Current [mA]	Efficiency @full load [% typ, min/typ Vin]	Max. capacitive load [μF]
LMO78_03-1.0	24 (6-36)	3.3	1000	90/81	680
LMO78_05-1.0	24 (8-36) 12 (8-27)	5 -5	1000 -500	93/86 86/82	680 330
LMO78_12-1.0	24 (16-36) 12 (8-20)	12 -12	1000 -300	96/93 89/88	680 330
LMO78_15-1.0	24 (20-36) 12 (8-18)	15 -15	1000 -300	96/94 89/89	680 330

Typical characteristics

Temperature Derating Curve

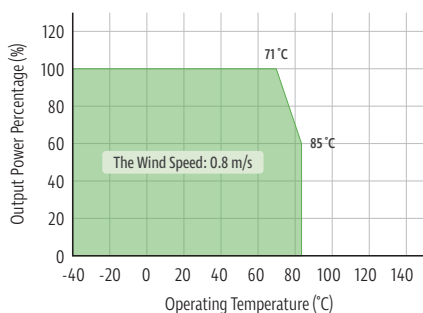

Efficiency

Positive Output Efficiency Vs Input Voltage (Full Load)

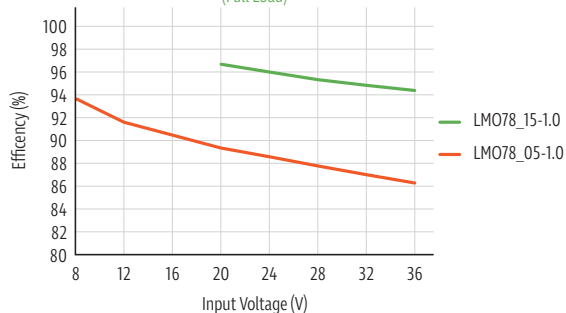

Positive Output Efficiency Vs Output Load (Vin=Vin-nominal)

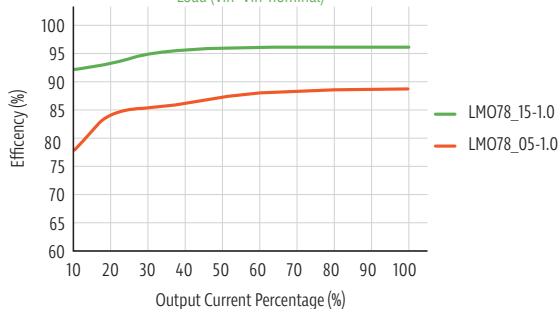

Negative Output Efficiency Vs Input Voltage (Full Load)

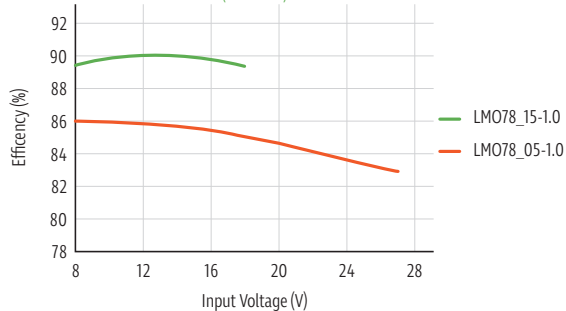

Negative Output Efficiency Vs Output Load (Vin=Vin-nominal)

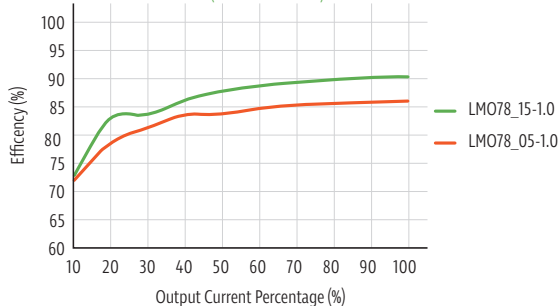

LMO78_1.0 series

Wide Input Non-Isolated & Regulated, Single Positive/Negative Output

Typical application circuit

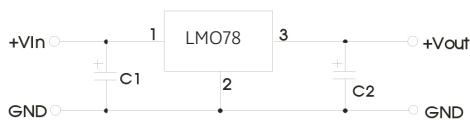

Positive output application circuit

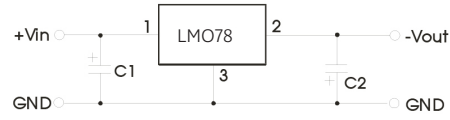

Negative output application circuit

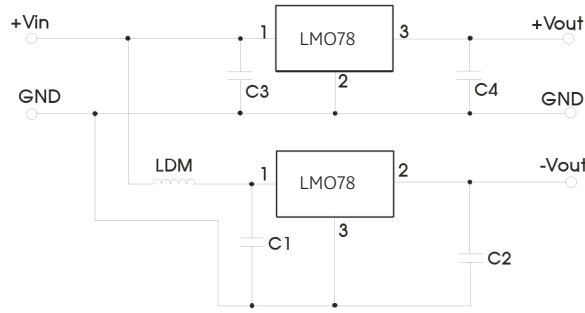

Positive and Negative output paralleling application circuit

Part number	C1,C3 (Ceramic Capacitor)	C2,C4 (Ceramic Capacitor)
LMO78_03-1.0	10 μ F/50V	22 μ F/10V
LMO78_05-1.0	10 μ F/50V	22 μ F/10V
LMO78_12-1.0	10 μ F/50V	22 μ F/25V
LMO78_15-1.0	10 μ F/50V	22 μ F/25V

Note:

1. C1 and C2 (C3 and C4) are required and should be connected close to the pin terminal of the module.
2. The capacitance of C1 and C2 (C3 and C4) refer to table on the left.
3. To reduce the output ripple furtherly, C2 and C4 can be increased properly if required, and tantalum or low ESR electrolytic capacitors may also suffice.
4. When the products are used as shown in the „positive and negative output paralleling application circuit“, an inductor named as LDM up to 10 μ H is recommended in the circuit to reduce the mutual interference.
5. Cannot be used in parallel for output and hot swap.

EMC solution-recommended circuit

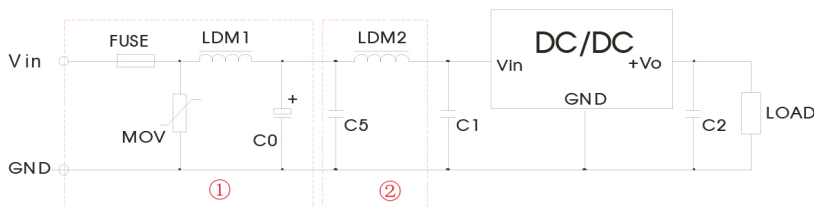

Part ① in the Fig. 5 is for EMS test, part ② is for EMI filtering; parts and can be added based on actual requirement.

FUSE	MOV	LDM1	C0	C1/C2	C5	LDM2
Selected based on the actual input current from the customer	S20K30	82 μ H	680 μ F /50V	Refer to table at typical application circuit	4.7 μ F /50V	12 μ H

LMO78_1.0 series

Wide Input Non-Isolated & Regulated, Single Positive/Negative Output

Mechanical dimensions and footprint

THIRD ANGLE PROJECTION 

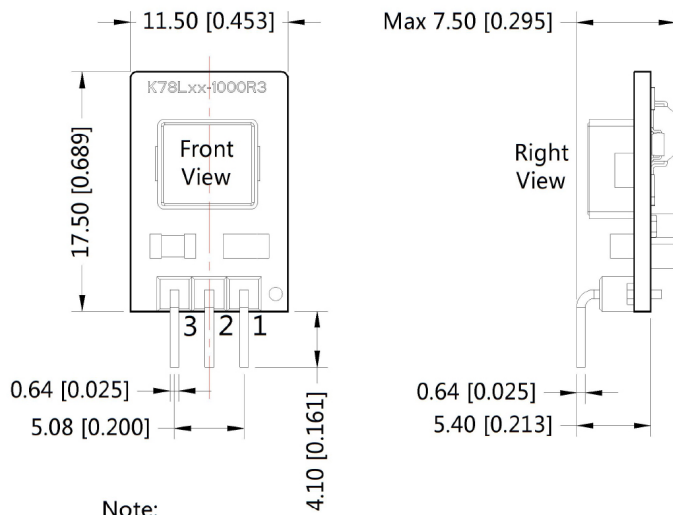

Note:

Unit :mm[inch]

Pin section tolerances : $\pm 0.10[\pm 0.004]$

General tolerances: $\pm 0.50[\pm 0.020]$

$\phi 1.20 [\phi 0.047]$

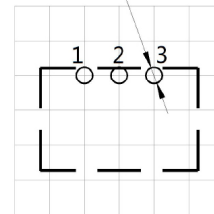

Note : Grid 2.54*2.54mm

Pin-Out		
Pin	Positive Output	Negative Output
1	V _{in}	V _{in}
2	GND	-V _o
3	+V _o	GND