

ohne Verriegelung
without interlocking

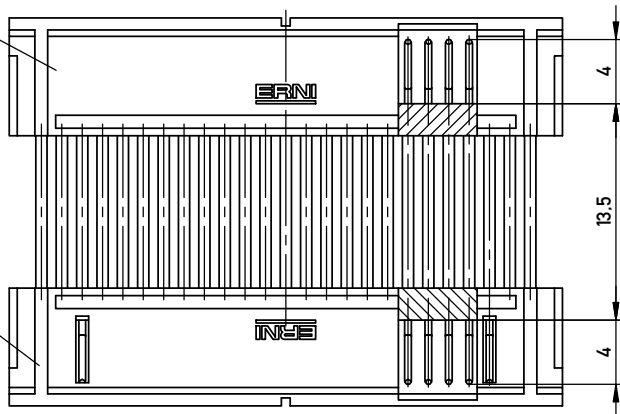

mit Verriegelung
with interlocking

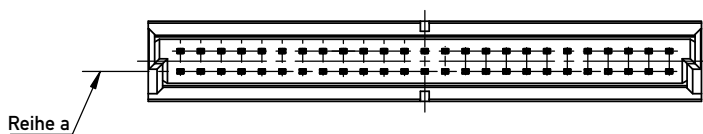

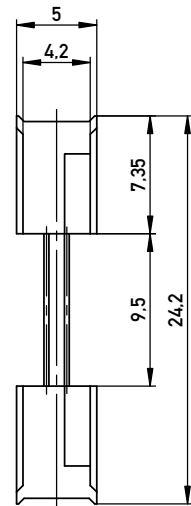

Verpackt in Tray -tray packaging
Verpackungseinheit 26 Stück -packaging unit 26

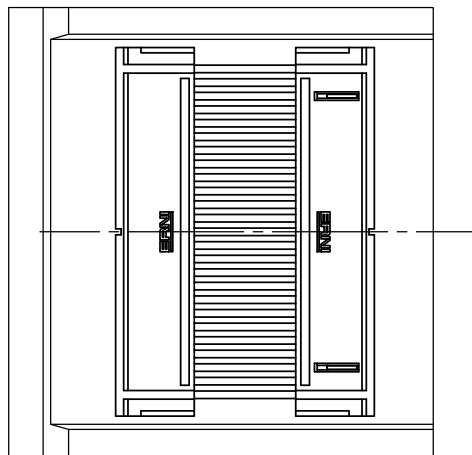
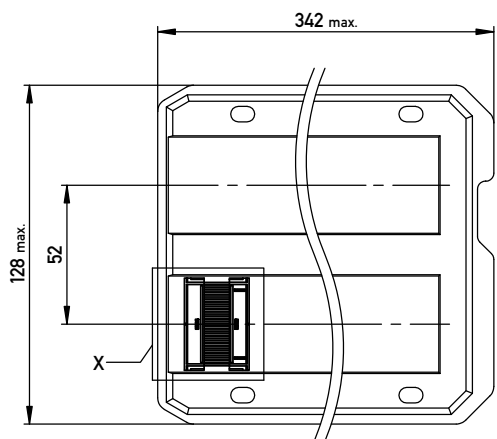
Einzelheit X (M 2:1)
detail X



Adapterstück für board-to-board Abstand von 26mm (beidseitig verbaut mit Federleiste: 154807, Low Profile)
Adapter for board-to-board height 26mm (in combination with two female connectors: 154807, low profile)

Information: All rights reserved. Only for Information. To ensure that this is the latest version of this drawing, please contact one of the ERNI companies before using.	Tolerances  All Dimensions in mm	Scale 3:1		
	Subject to modification without prior notice. Drawing will not be updated.	Designation 1,27 DRC Adapterstück BTB 26mm 50-polig		
a Index	28.07.2015 Date	 www.ERNI.com 354310		I A3
		Class DRCBTB		

Copyright by ERNI GmbH
Proprietary notice pursuant to ISO 16016 to be observed.