

## Surface-Mount Glass Passivated Rectifier

**SMC (DO-214AB)**

Cathode Anode

### FEATURES

- Low profile package
- Ideal for automated placement
- Glass passivated pellet chip junction
- Low forward voltage drop
- Low leakage current
- High forward surge capability
- Meets MSL level 1, per J-STD-020, LF maximum peak of 260 °C
- Material categorization: for definitions of compliance please see [www.vishay.com/doc?99912](http://www.vishay.com/doc?99912)

**RoHS**  
COMPLIANT

### LINKS TO ADDITIONAL RESOURCES



3D Models

### TYPICAL APPLICATIONS

For use in general purpose rectification of power supplies, inverters, converters, and freewheeling diodes for consumer, and telecommunication.

PRIMARY CHARACTERISTICS	
$I_{F(AV)}$	8.0 A
$V_{RRM}$	400 V, 600 V, 800 V, 1000 V
$I_{FSM}$	200 A
$I_R$	10 $\mu$ A
$V_F$ at $I_F = 8$ A ( $T_J = 125$ °C)	0.87 V
$T_J$ max.	150 °C
Package	SMC (DO-214AB)
Circuit configuration	Single

### MECHANICAL DATA

**Case:** SMC (DO-214AB)

Molding compound meets UL 94 V-0 flammability rating  
Base P/N-E3 - RoHS-compliant , commercial grade

**Terminals:** matte tin plated leads, solderable per J-STD-002 and JESD 22-B102

E3 suffix meets JESD 201 class 2 whisker test

**Polarity:** color band denotes cathode end

MAXIMUM RATINGS ( $T_A = 25$ °C unless otherwise noted)						
PARAMETER	SYMBOL	S8GS	S8JS	S8KS	S8MS	UNIT
Device marking code		S8GS	S8JS	S8KS	S8MS	
Maximum repetitive peak reverse voltage	$V_{RRM}$	400	600	800	1000	V
Maximum RMS voltage	$V_{RMS}$	280	420	560	700	V
Maximum DC blocking voltage	$V_{DC}$	400	600	800	1000	V
Maximum average forward rectified current	$I_{F(AV)}$ <sup>(1)</sup>	8.0				A
	$I_{F(AV)}$ <sup>(2)</sup>	1.6				A
Peak forward surge current 8.3 ms single half sine-wave superimposed on rated load	$I_{FSM}$	200				A
Peak forward surge current single half sine-wave at 1.0 ms	$I_{FSM}$	450				A
Operating junction and storage temperature range	$T_J, T_{STG}$	-55 to +150				°C

### Notes

- (1) Mounted on aluminum PCB 30 mm x 30 mm with aluminum heatsink
- (2) Free air, mounted on recommended copper pad area



<b>ELECTRICAL CHARACTERISTICS</b> ( $T_J = 25\text{ }^\circ\text{C}$ unless otherwise noted)						
PARAMETER	TEST CONDITIONS		SYMBOL	TYP.	MAX.	UNIT
Instantaneous forward voltage	$I_F = 4.0\text{ A}$	$T_J = 25\text{ }^\circ\text{C}$	$V_F^{(1)}$	0.90	-	V
	$I_F = 8.0\text{ A}$			0.97	0.985	
	$I_F = 4.0\text{ A}$	$T_J = 125\text{ }^\circ\text{C}$		0.80	-	
	$I_F = 8.0\text{ A}$			0.87	0.971	
Reverse current	Rated $V_R$	$T_J = 25\text{ }^\circ\text{C}$	$I_R^{(2)}$	-	10	$\mu\text{A}$
		$T_J = 125\text{ }^\circ\text{C}$		-	180	
Typical reverse recovery time	$I_F = 0.5\text{ A}, I_R = 1.0\text{ A}, I_{rr} = 0.25\text{ A}$		$t_{rr}$	3.4	-	$\mu\text{s}$
Typical junction capacitance	4.0 V, 1 MHz		$C_J$	63	-	pF

**Notes**

- (1) Pulse test: 300  $\mu\text{s}$  pulse width; 1 % duty cycle
- (2) Pulse test: pulse width  $\leq 40\text{ ms}$

<b>THERMAL CHARACTERISTICS</b> ( $T_A = 25\text{ }^\circ\text{C}$ unless otherwise noted)						
PARAMETER	SYMBOL	S8GS	S8JS	S8KS	S8MS	UNIT
Typical thermal resistance	$R_{\theta JA}^{(1)(2)}$	88				$^\circ\text{C/W}$
	$R_{\theta JM}^{(3)}$	4.5				

**Notes**

- (1) The heat generated must be less than the thermal conductivity from junction-to-ambient:  $dP_D/R_{\theta JA}$
- (2) Thermal resistance junction-to-ambient to follow JEDEC<sup>®</sup> 51-2A, device mounted on FR4 PCB, 2 oz., standard footprint
- (3) Thermal resistance junction-to-mount to follow JEDEC<sup>®</sup> 51-14 transient dual interface test method (TDIM)

<b>ORDERING INFORMATION</b> (Example)				
PREFERRED P/N	UNIT WEIGHT (g)	PREFERRED PACKAGE CODE	BASE QUANTITY	DELIVERY MODE
S8JS-E3/I	0.243	I	3500	13" diameter plastic tape and reel

**RATINGS AND CHARACTERISTICS CURVES** ( $T_A = 25\text{ }^\circ\text{C}$  unless otherwise noted)

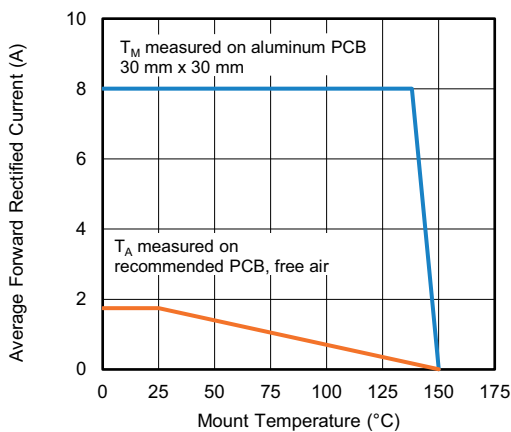

Fig. 1 - Forward Current Derating Curve

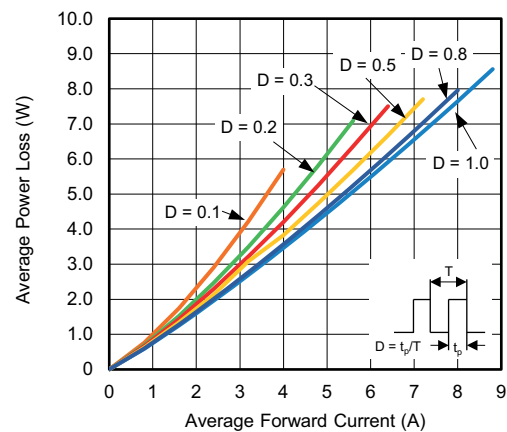

Fig. 2 - Average Power Loss Characteristics

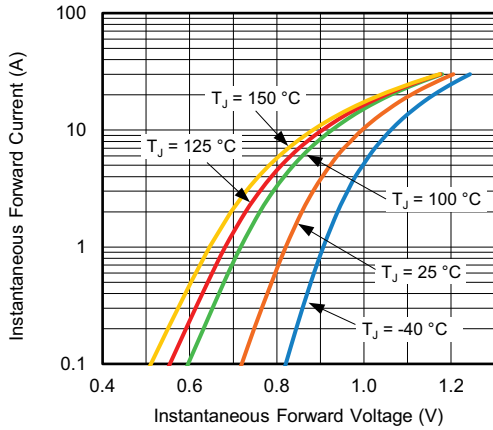

Fig. 3 - Typical Instantaneous Forward Characteristics

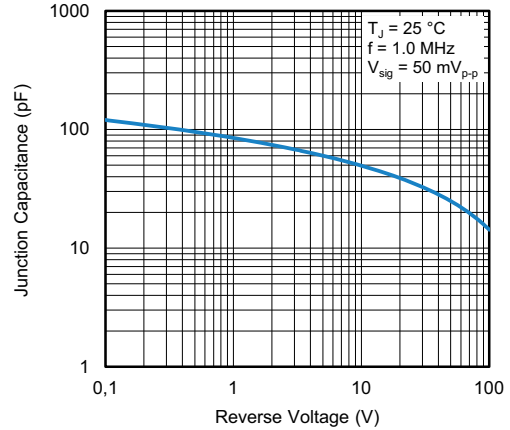

Fig. 5 - Typical Junction Capacitance

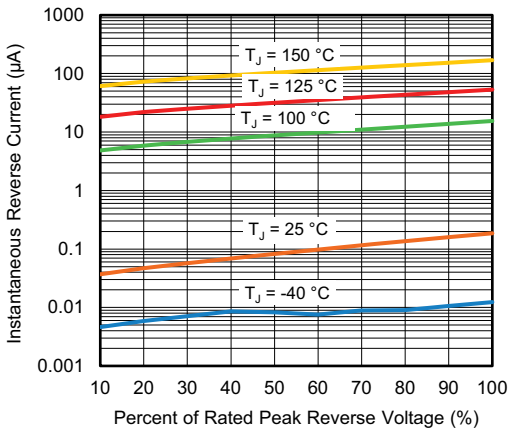

Fig. 4 - Typical Reverse Characteristics

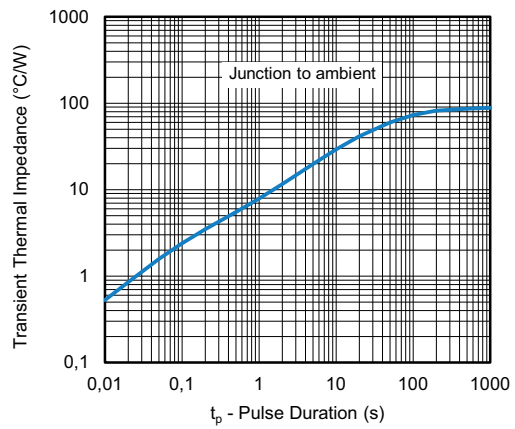
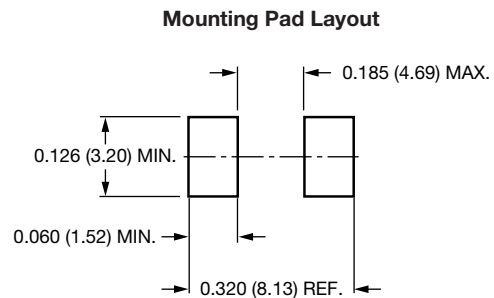
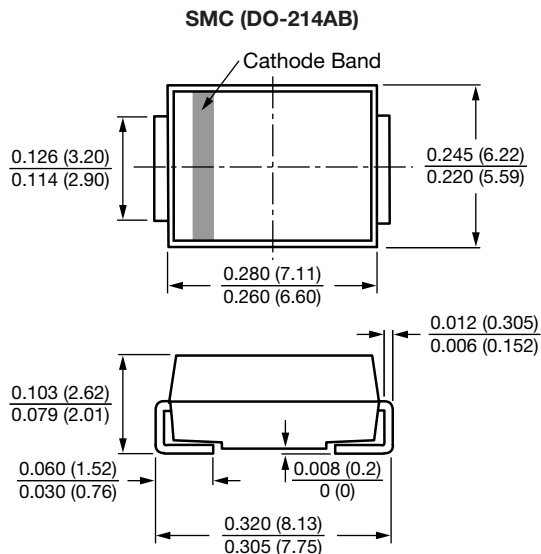

Fig. 6 - Transient Thermal Impedance

**PACKAGE OUTLINE DIMENSIONS** in inches (millimeters)





## Disclaimer

ALL PRODUCT, PRODUCT SPECIFICATIONS AND DATA ARE SUBJECT TO CHANGE WITHOUT NOTICE TO IMPROVE RELIABILITY, FUNCTION OR DESIGN OR OTHERWISE.

Vishay Intertechnology, Inc., its affiliates, agents, and employees, and all persons acting on its or their behalf (collectively, "Vishay"), disclaim any and all liability for any errors, inaccuracies or incompleteness contained in any datasheet or in any other disclosure relating to any product.

Vishay makes no warranty, representation or guarantee regarding the suitability of the products for any particular purpose or the continuing production of any product. To the maximum extent permitted by applicable law, Vishay disclaims (i) any and all liability arising out of the application or use of any product, (ii) any and all liability, including without limitation special, consequential or incidental damages, and (iii) any and all implied warranties, including warranties of fitness for particular purpose, non-infringement and merchantability.

Statements regarding the suitability of products for certain types of applications are based on Vishay's knowledge of typical requirements that are often placed on Vishay products in generic applications. Such statements are not binding statements about the suitability of products for a particular application. It is the customer's responsibility to validate that a particular product with the properties described in the product specification is suitable for use in a particular application. Parameters provided in datasheets and / or specifications may vary in different applications and performance may vary over time. All operating parameters, including typical parameters, must be validated for each customer application by the customer's technical experts. Product specifications do not expand or otherwise modify Vishay's terms and conditions of purchase, including but not limited to the warranty expressed therein.

Hyperlinks included in this datasheet may direct users to third-party websites. These links are provided as a convenience and for informational purposes only. Inclusion of these hyperlinks does not constitute an endorsement or an approval by Vishay of any of the products, services or opinions of the corporation, organization or individual associated with the third-party website. Vishay disclaims any and all liability and bears no responsibility for the accuracy, legality or content of the third-party website or for that of subsequent links.

Except as expressly indicated in writing, Vishay products are not designed for use in medical, life-saving, or life-sustaining applications or for any other application in which the failure of the Vishay product could result in personal injury or death. Customers using or selling Vishay products not expressly indicated for use in such applications do so at their own risk. Please contact authorized Vishay personnel to obtain written terms and conditions regarding products designed for such applications.

No license, express or implied, by estoppel or otherwise, to any intellectual property rights is granted by this document or by any conduct of Vishay. Product names and markings noted herein may be trademarks of their respective owners.