



Product Name: HB80DG External Antenna

Part Number: H2MA704K104100

Features:

- Supporting: (L1+L2) GPS/GLONASS/BDS/Galileo/QZSS
- Stable and reliable in performances
- Low temperature coefficient of frequency
- RoHS & REACH Compliant
- Pre-filtering

Applications:

- Navigation systems or position tracking systems
- Car Navigation
- Security Surveillance

External Antenna

MODEL: HB80DG

Version: Preliminary

I. Patch antenna Specifications:

Items	Specifications			
Navigation	BDS B1/	GPS L1/ Galileo E1/ QZSS L1	GLONASS G1/	GPS L2/ GLONASS G2/ QZSS L2
Center Frequency (MHz)	1561	1575.42	1602	1227.6
Return loss (dB)	<-10 Typ.	<-10 Typ.	<-10 Typ.	<-10 Typ.
Efficiency (%)	64 Typ.	70 Typ.	52 Typ.	52 Typ.
Average Gain (dB)	-2.0 Typ.	-1.6 Typ.	-2.9 Typ.	-2.8 Typ.
Peak Gain (dBi)	4.5 Typ.	5.0 Typ.	3.9 Typ.	3.2 Typ.
Axial Ratio (dB)	1.7 Typ.	1.7 Typ.	1.7 Typ.	2.5 Typ.
Polarization	RHCP			
Impedance (Ω)	50			

II. Low noise amplifier Specifications:

Items	Specifications			
Navigation	BDS B1	GPS L1	GLONASS G1	L2 Band
Center Frequency (MHz)	1561	1575.42	1602	1227.6
Gain (dB)	28 \pm 3 Typ.	28 \pm 3 Typ.	28 \pm 3 Typ.	28 \pm 3 Typ.
Noise Figure (dB)	3.0 Typ.	2.7 Typ.	3.0 Typ.	3.0 Typ.
Input Voltage (V)	DC = 3.0 \pm 0.3			
Current (mA)	12.5 Typ. (at DC 3V)			
Impedance (Ω)	50			

© Unictron Technologies Corp.
All specifications subject to change without notice.

Environmental Conditions	
Operation & Storage Temperature (° C)	-40 ~ +85
Storage Temperature (° C) (Antenna with packing sealed)	-5 ~ +40
Relative Humidity	10 ~ 70 %

III. Antenna Dimensions (unit: mm):

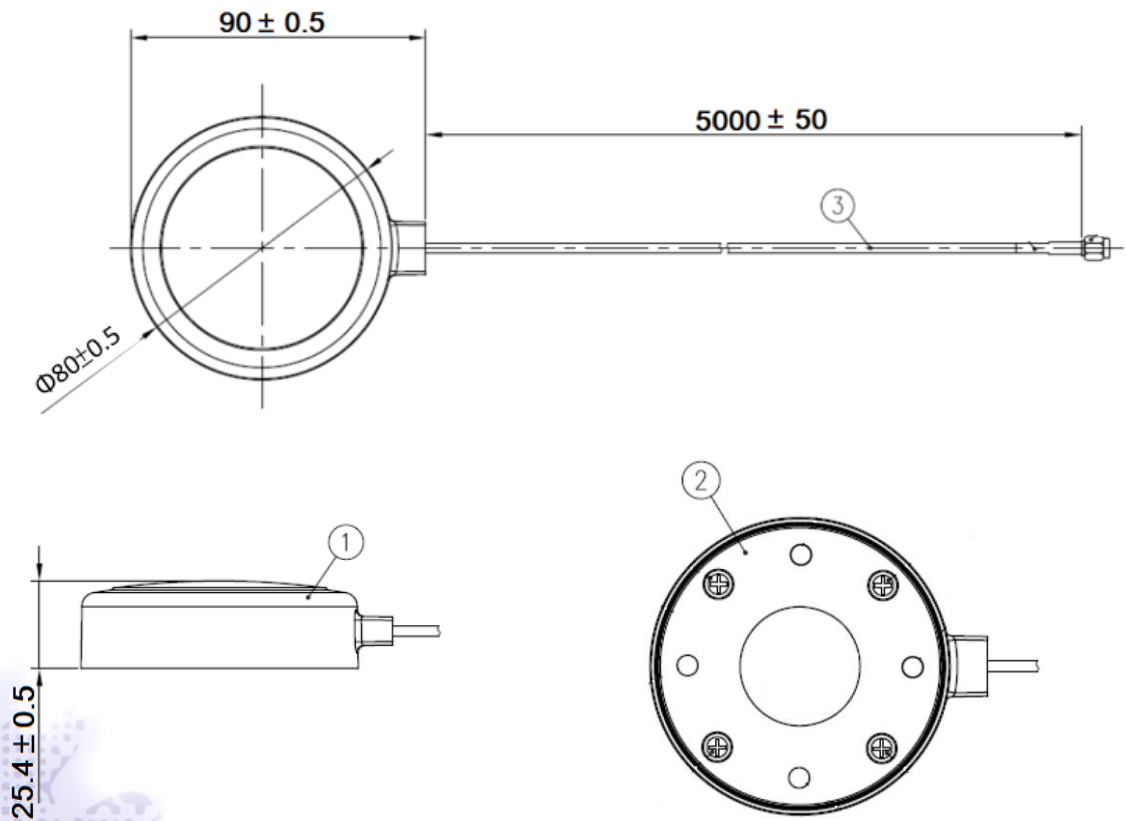

Item	Name	Material	Color	Q'ty
1	Top Housing	PC+ABS	Black	1
2	Bottom Base	Zinc Alloy	Ni Plated	1
3	Connector cable \varnothing 2.7mm	PVC	Black	1

IV. Properties:

a) Return loss (dB)

L1 Band (1561 & 1575.42 & 1602MHz)

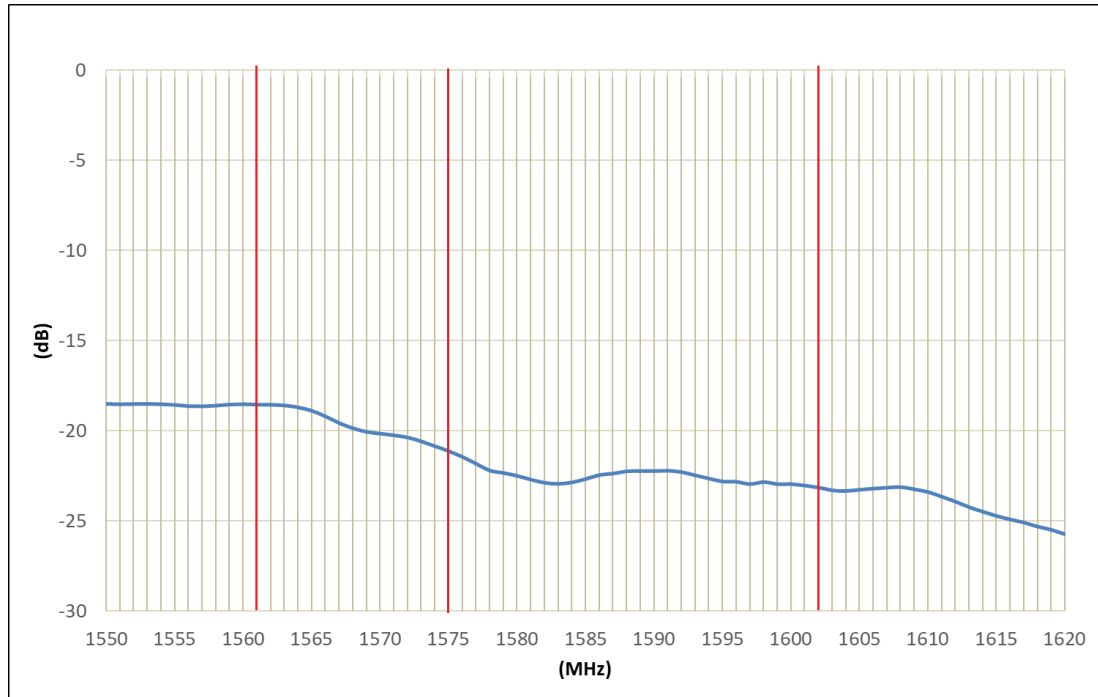

L2 Band (1227.6 MHz)

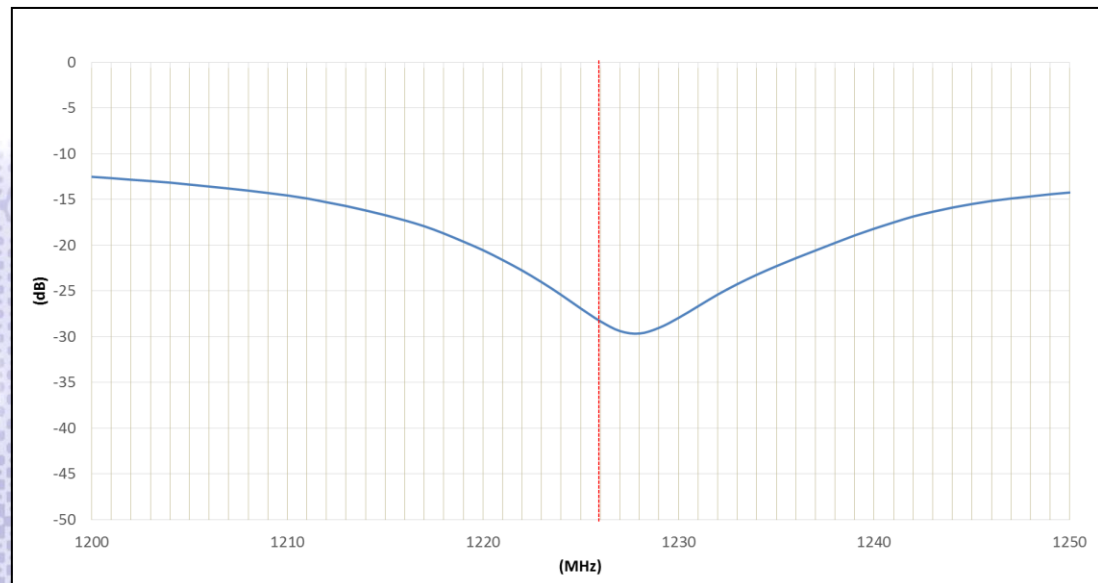

b) Efficiency (%)

L1 Band (1561 & 1575.42 & 1602MHz)

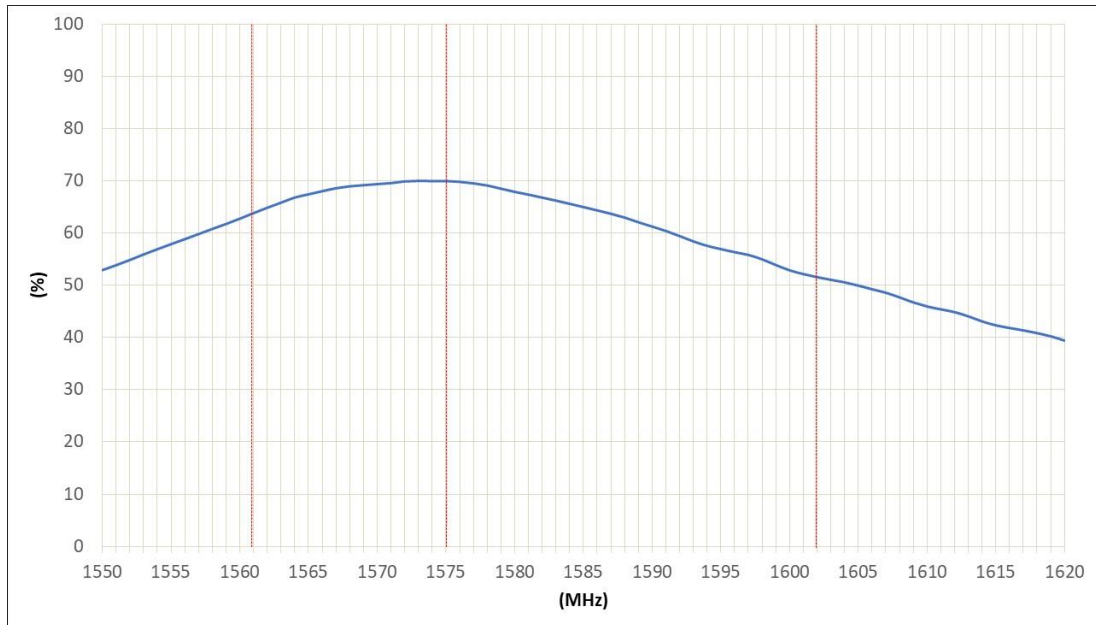

© Unictron Technologies Corp.
All specifications subject to change without notice.

L2 Band (1227.6 MHz)

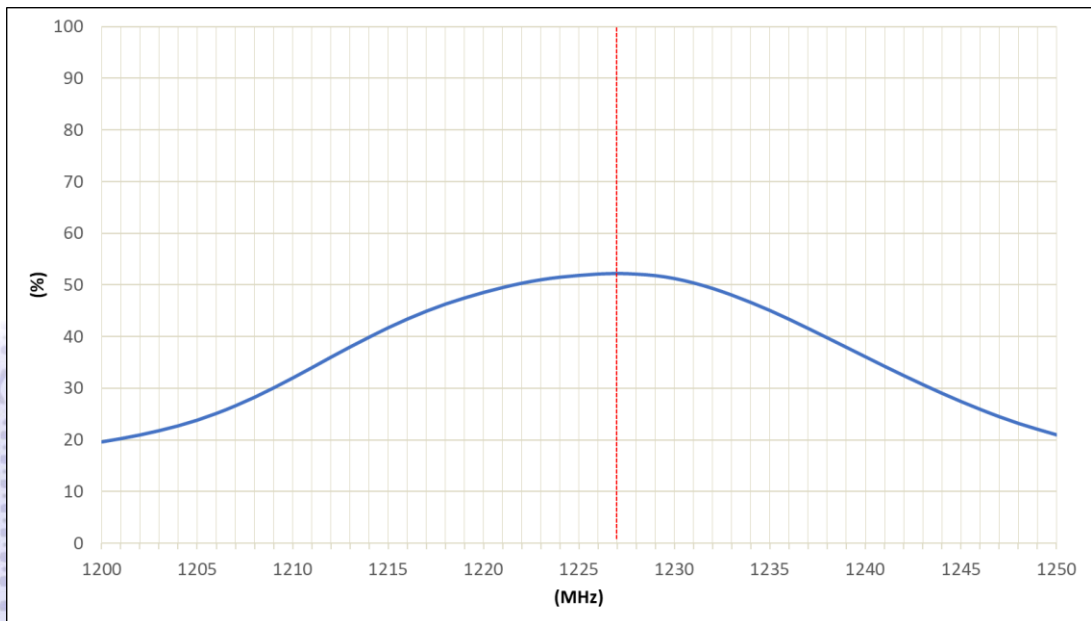

c) Average Gain (dB)

L1 Band (1561 & 1575.42 & 1602MHz)

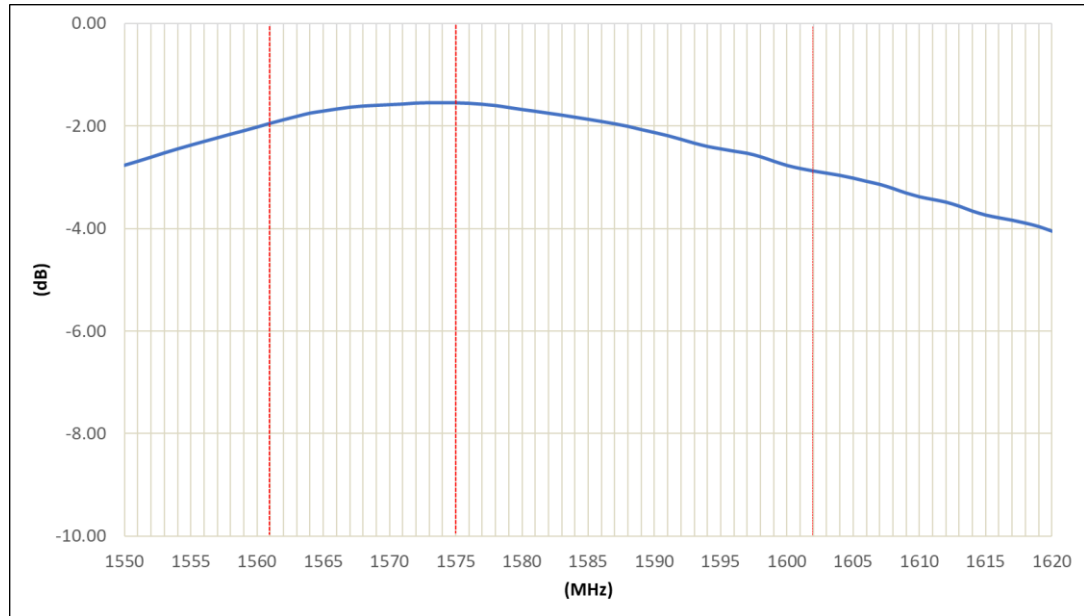

© Unictron Technologies Corp.
All specifications subject to change without notice.

L2 Band (1227.6 MHz)

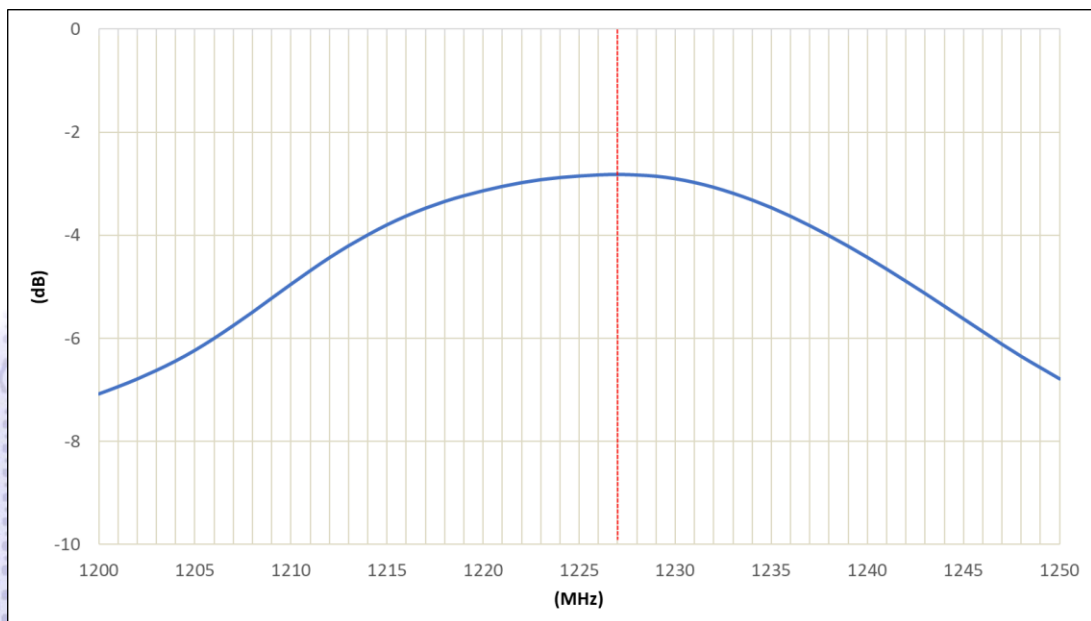

d) Peak Gain (dBi)

L1 Band (1561 & 1575.42 & 1602MHz)

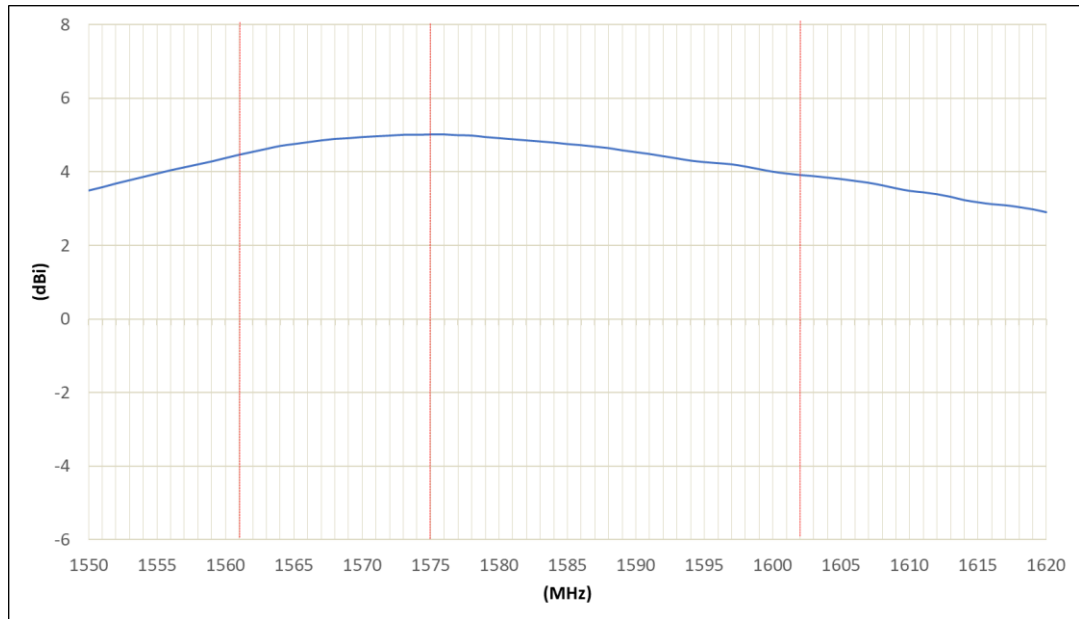

© Unictron Technologies Corp.
All specifications subject to change without notice.

L2 Band (1227.6 MHz)

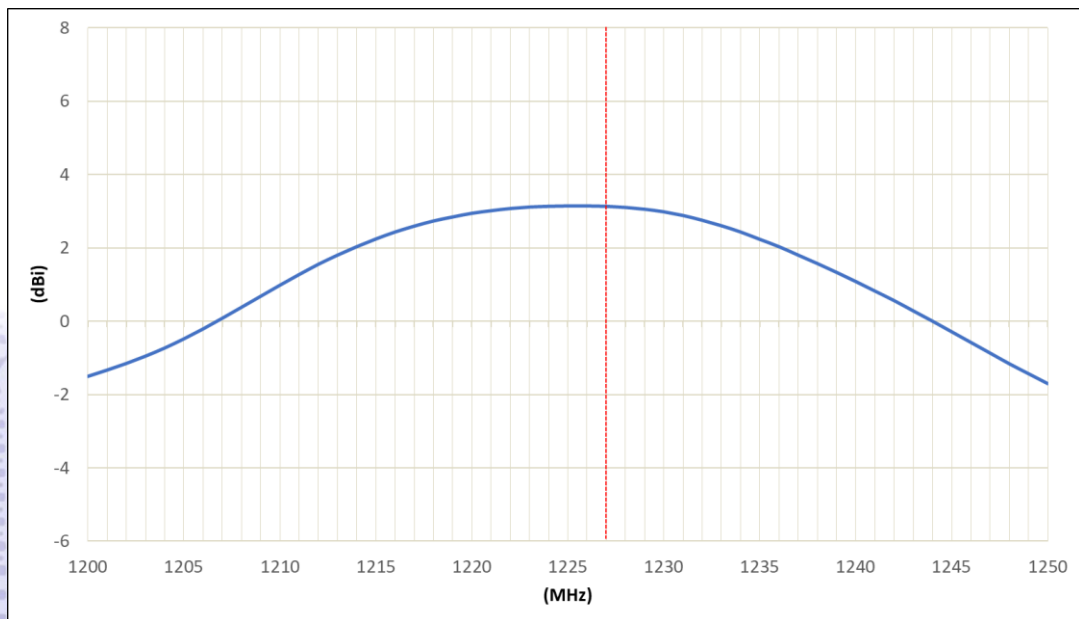

e) Axial Ratio (dB)

L1 Band (1561 & 1575.42 & 1602MHz)

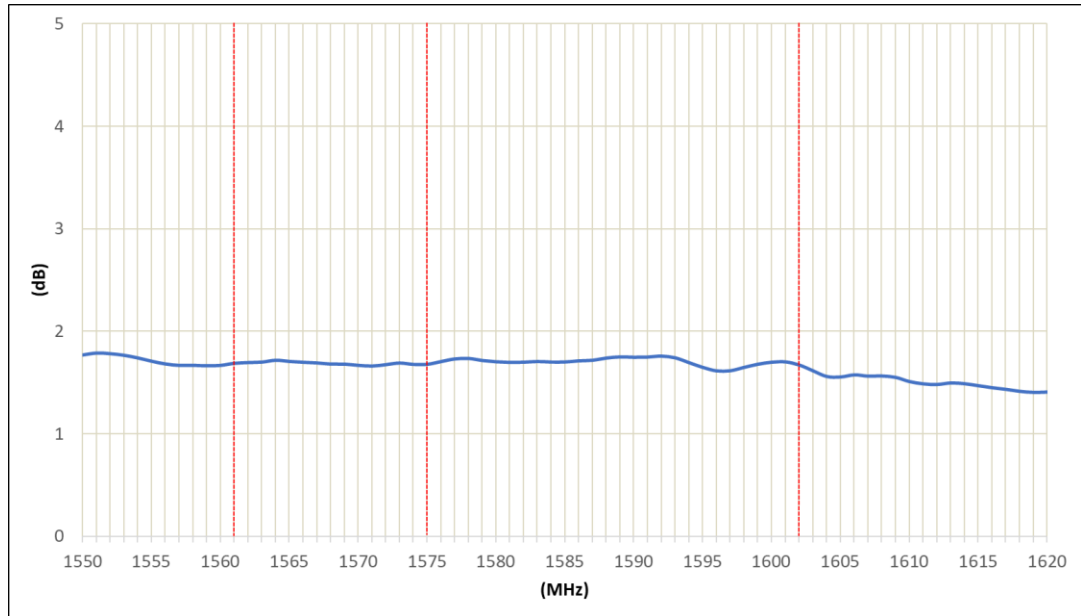

L2 Band (1227.6 MHz)

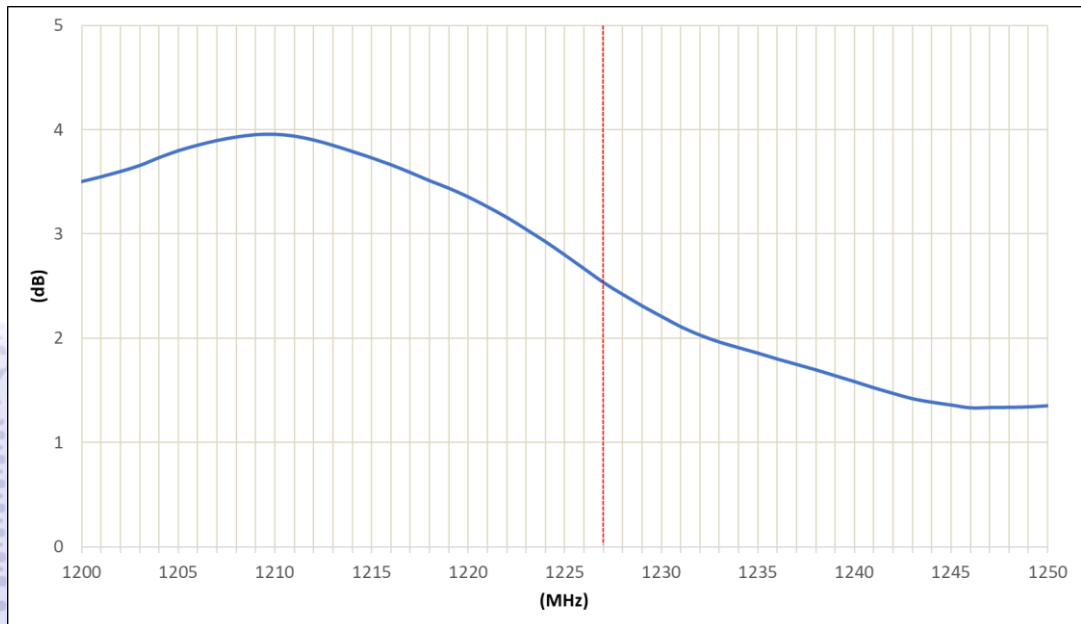

© Unictron Technologies Corp.
All specifications subject to change without notice.

V. Antenna Radiation Pattern Measurement:

The antenna radiation patterns are measured in Unictron's 3D Anechoic Chamber. The measurement setup is as show below.



© Unictron Technologies Corp.
All specifications subject to change without notice.

3D Radiation Gain Pattern

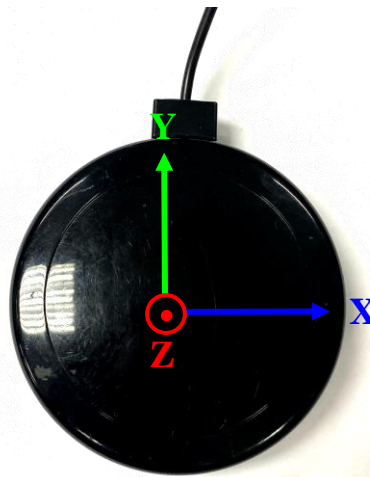

a) 1561 MHz (unit: dBi)

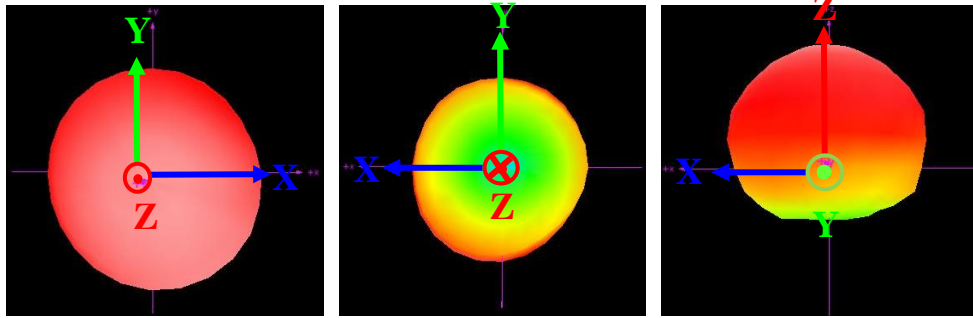

b) 1575.42 MHz (unit: dBi)

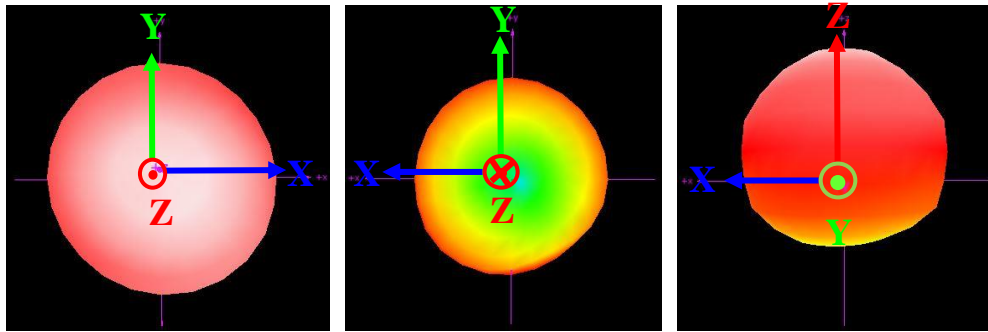

c) 1602 MHz (unit: dBi)

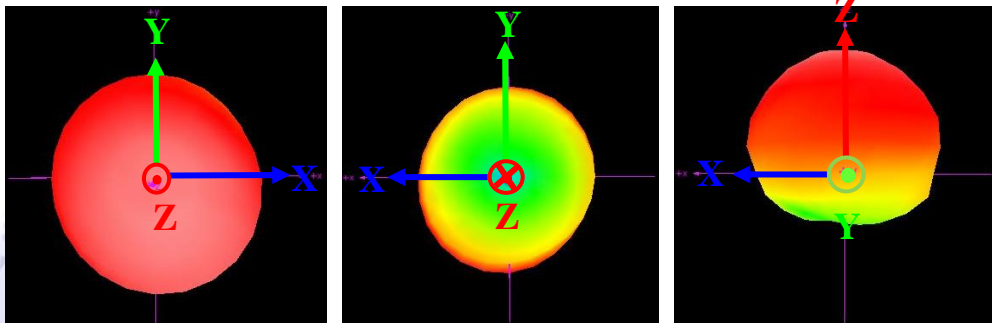

d) 1227.6 MHz (unit: dBi)

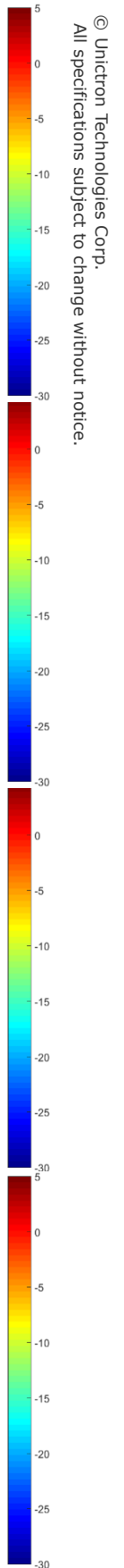
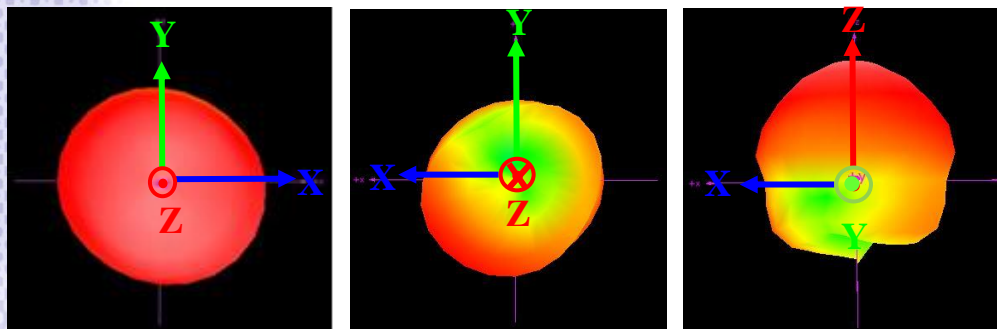



© Unictron Technologies Corp.
All specifications subject to change without notice.

VI. Package

- a) Weight:
Unit Weight: 242 ± 25 (g)
- b) Quantity:
Each PE : 1 pcs
Each outer carton : 100 pcs

© Unictron Technologies Corp.
All specifications subject to change without notice.

Step	Pictures	Descriptions												
1		First, put one antenna into a PE bag (160x165 mm), PE bags are sealed by sealing machine .												
2		Put all the PE bags into the carton. Each carton should contain 100 pcs of antenna.												
3	 <table border="1" data-bbox="488 1765 735 1937"> <tr> <td>Unictron P/N :</td> <td>H2M3A023C20100</td> </tr> <tr> <td>Part No. :</td> <td>120300000230A</td> </tr> <tr> <td>PO No. :</td> <td>DSR1805074JA</td> </tr> <tr> <td>Q'TY :</td> <td>100 PCS</td> </tr> <tr> <td>D/C :</td> <td>1821</td> </tr> <tr> <td>DATE :</td> <td>2018.05.21</td> </tr> </table>	Unictron P/N :	H2M3A023C20100	Part No. :	120300000230A	PO No. :	DSR1805074JA	Q'TY :	100 PCS	D/C :	1821	DATE :	2018.05.21	After wrapping the carton, place the barcode label on the top right corner of the carton.
Unictron P/N :	H2M3A023C20100													
Part No. :	120300000230A													
PO No. :	DSR1805074JA													
Q'TY :	100 PCS													
D/C :	1821													
DATE :	2018.05.21													