

NPN Silicon AF Transistors

- For AF driver and output stages
- High collector current
- Low collector-emitter saturation voltage
- Complementary types: BCX51...BCX53 (PNP)

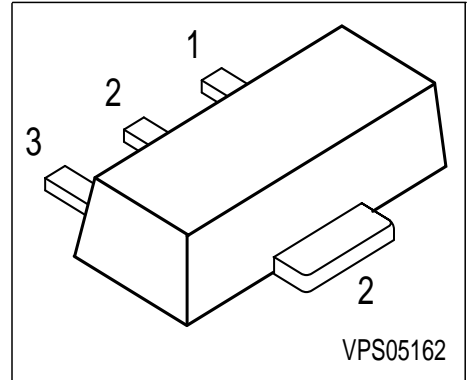

Type	Marking	Pin Configuration			Package
BCX54	BA	1 = B	2 = C	3 = E	SOT89
BCX54-10	BC	1 = B	2 = C	3 = E	SOT89
BCX54-16	BD	1 = B	2 = C	3 = E	SOT89
BCX55	BE	1 = B	2 = C	3 = E	SOT89
BCX55-10	BG	1 = B	2 = C	3 = E	SOT89
BCX55-16	BM	1 = B	2 = C	3 = E	SOT89
BCX56	BH	1 = B	2 = C	3 = E	SOT89
BCX56-10	BK	1 = B	2 = C	3 = E	SOT89
BCX56-16	BL	1 = B	2 = C	3 = E	SOT89

Maximum Ratings

Parameter	Symbol	BCX54	BCX55	BCX56	Unit
Collector-emitter voltage	V_{CEO}	45	60	80	V
Collector-base voltage	V_{CBO}	45	60	100	
Emitter-base voltage	V_{EBO}	5	5	5	
DC collector current	I_C	1			A
Peak collector current	I_{CM}	1.5			
Base current	I_B	100			mA
Peak base current	I_{BM}	200			
Total power dissipation, $T_S = 130\text{ °C}$	P_{tot}	1			W
Junction temperature	T_j	150			°C
Storage temperature	T_{stg}	-65 ... 150			

Thermal Resistance

Junction - soldering point ¹⁾	R_{thJS}	≤20			K/W
--	------------	-----	--	--	-----

¹⁾For calculation of R_{thJA} please refer to Application Note Thermal Resistance

Electrical Characteristics at $T_A = 25^\circ\text{C}$, unless otherwise specified.

Parameter	Symbol	Values			Unit
		min.	typ.	max.	
DC Characteristics					
Collector-emitter breakdown voltage $I_C = 10\text{ mA}, I_B = 0$	$V_{(BR)CEO}$				V
BCX54		45	-	-	
BCX55		60	-	-	
BCX56		80	-	-	
Collector-base breakdown voltage $I_C = 100\ \mu\text{A}, I_B = 0$	$V_{(BR)CBO}$				
BCX54		45	-	-	
BCX55		60	-	-	
BCX56		100	-	-	
Emitter-base breakdown voltage $I_E = 10\ \mu\text{A}, I_C = 0$	$V_{(BR)EBO}$	5	-	-	
Collector cutoff current $V_{CB} = 30\text{ V}, I_E = 0$	I_{CBO}	-	-	100	nA
Collector cutoff current $V_{CB} = 30\text{ V}, I_E = 0, T_A = 150^\circ\text{C}$	I_{CBO}	-	-	20	μA
DC current gain 1) $I_C = 5\text{ mA}, V_{CE} = 2\text{ V}$	h_{FE}	25	-	-	-
DC current gain 1) $I_C = 150\text{ mA}, V_{CE} = 2\text{ V}$	h_{FE}				
BCX54...56		40	-	250	
hFE-grp.10		63	100	160	
hFE-grp.16		100	160	250	
DC current gain 1) $I_C = 500\text{ mA}, V_{CE} = 2\text{ V}$	h_{FE}	25	-	-	
Collector-emitter saturation voltage1) $I_C = 500\text{ mA}, I_B = 50\text{ mA}$	V_{CEsat}	-	-	0.5	V
Base-emitter voltage 1) $I_C = 500\text{ mA}, V_{CE} = 2\text{ V}$	$V_{BE(ON)}$	-	-	1	
AC Characteristics					
Transition frequency $I_C = 50\text{ mA}, V_{CE} = 10\text{ V}, f = 20\text{ MHz}$	f_T	-	100	-	MHz

 1) Pulse test: $t \leq 300\ \mu\text{s}$, $D = 2\%$

Total power dissipation $P_{tot} = f(T_S)$

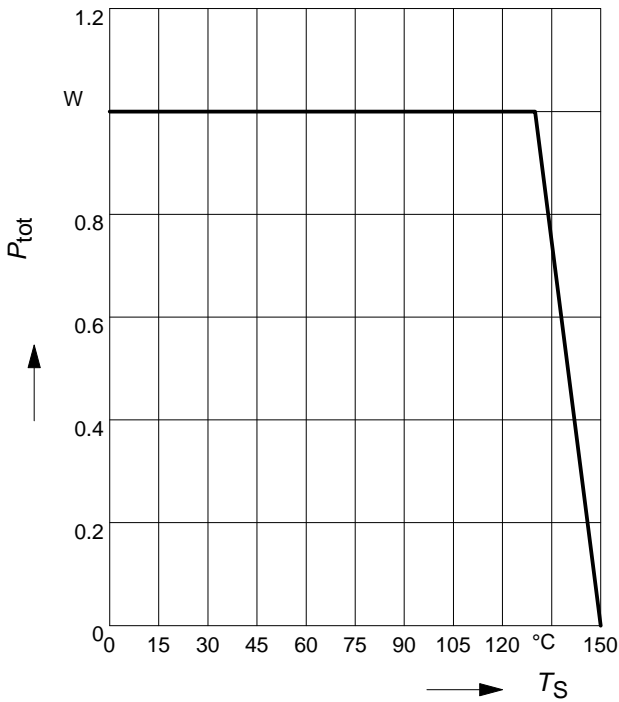

Transition frequency $f_T = f(I_C)$

$V_{CE} = 10V$

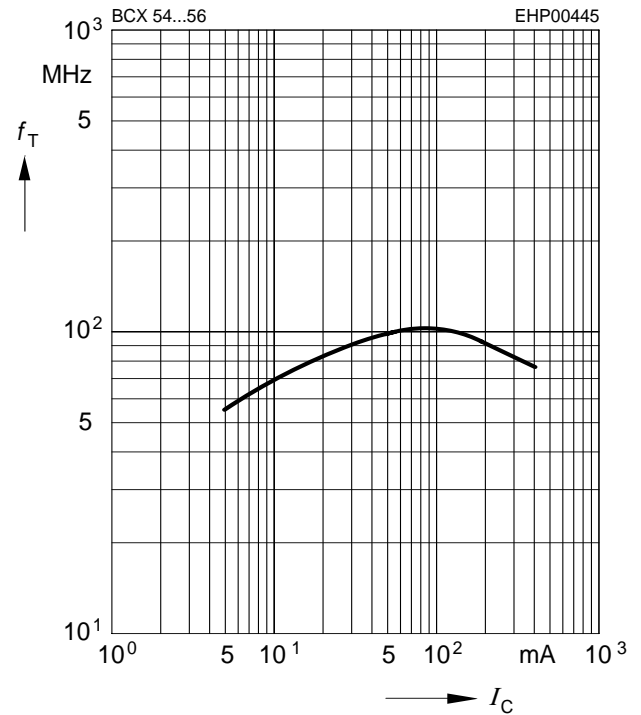

Permissible pulse load

$P_{totmax} / P_{totDC} = f(t_p)$

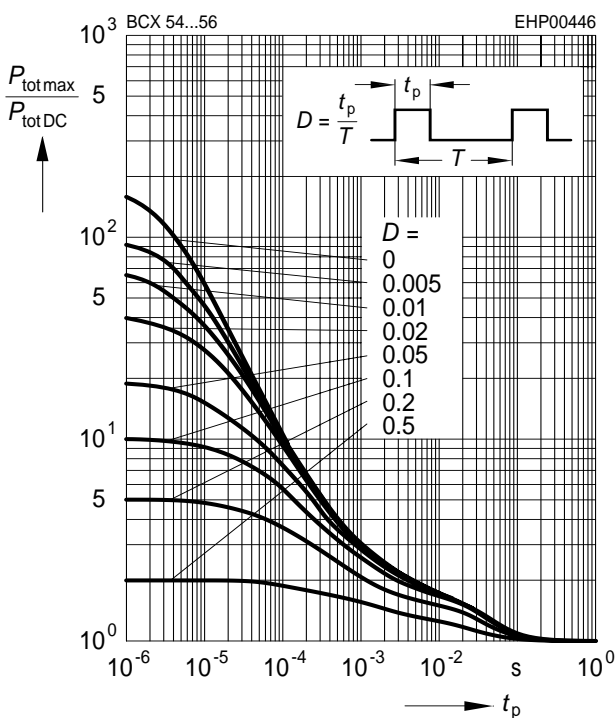

Collector cutoff current $I_{CBO} = f(T_A)$

$V_{CB} = 30V$

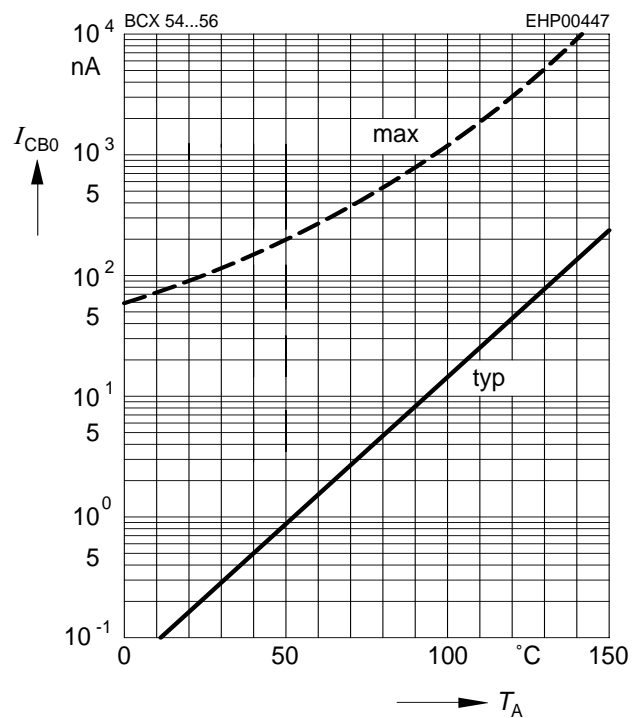

Collector current $I_C = f(V_{BE})$

$V_{CE} = 2V$

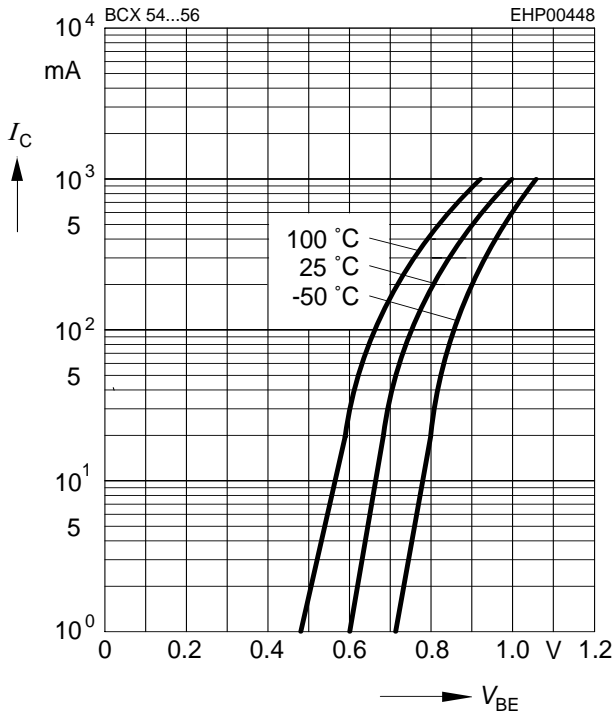

Collector-emitter saturation voltage $I_C = f(V_{CEsat}), h_{FE} = 10$

$I_C = f(V_{CEsat}), h_{FE} = 10$

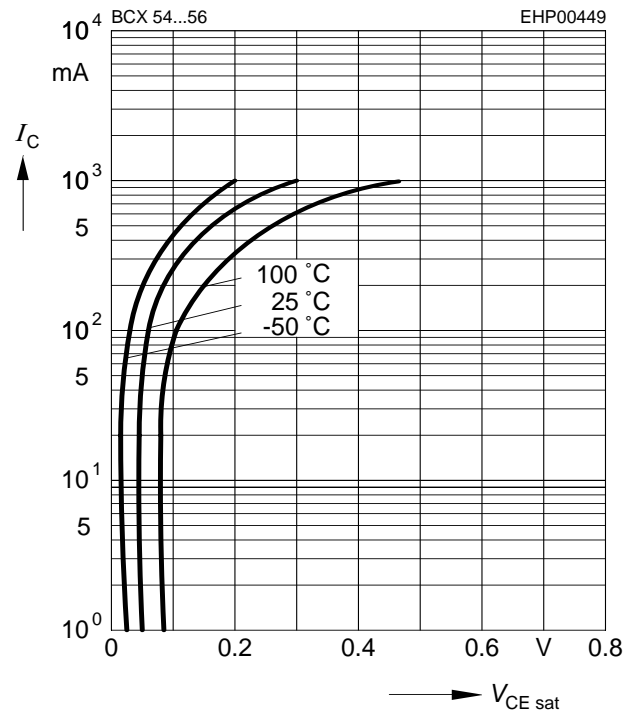

Base-emitter saturation voltage $I_C = f(V_{BEsat}), h_{FE} = 10$

$I_C = f(V_{BEsat}), h_{FE} = 10$

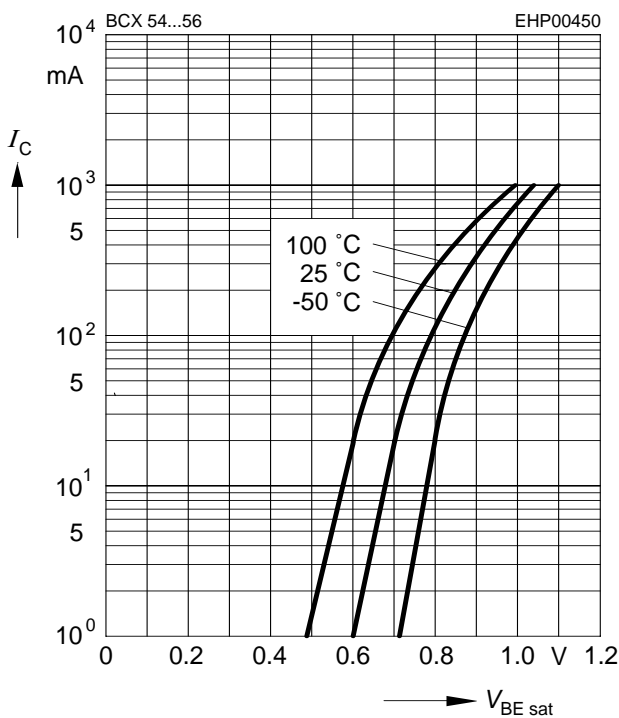

DC current gain $h_{FE} = f(I_C)$

$V_{CE} = 2V$

