

Designated client product

This product will be discontinued its production in the near term.
And it is provided for customers currently in use only, with a time limit.
It can not be available for your new project. Please select other new or existing products.

For more information, please contact our sales office in your region.

New Japan Radio Co.,Ltd.

www.njr.com

2-INPUT 3CHANNEL VIDEO SWITCH

■ GENERAL DESCRIPTION

NJM2283 is a switching IC for switching over from one audio or video input signal to another. Internalizing 2 inputs and 1 output, and then each set of 3 can be operated independently. It is a higher efficiency video switch, featuring the supply voltage range 4.75 to 13.0V, the frequency feature 10MHz, and then Crosstalk 75dB (at 4.43MHz).

■ FEATURES

- 2 Input-1 Output 3 Circuits internalizing
- Wide Operating Voltage (4.75V to 13V)
- Crosstalk 75dB (at 4.43MHz)
- Wide Operating Supply Range 10MHz (2V_{P-P} Input)
- Wide Bandwidth Frequency
- Package Outline DIP16, DMP16, SSOP16

■ APPLICATIONS

- VCR, Video Camera, AV-TV, Video Disk Player.

■ BLOCK DIAGRAM

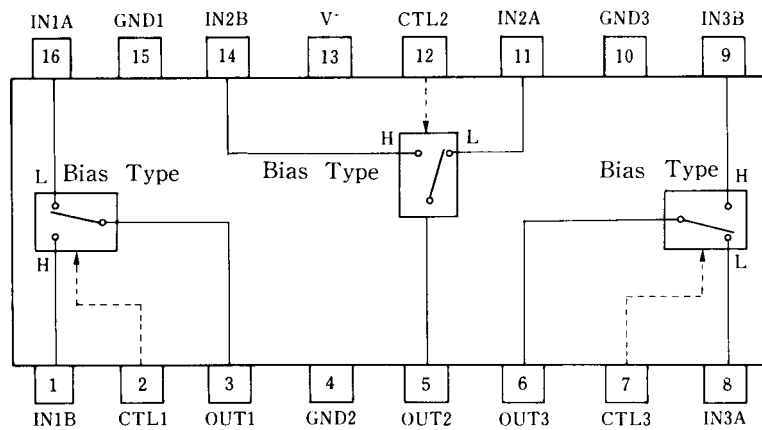

NJM2283D
NJM2283M
NJM2283V

■ PACKAGE OUTLINE

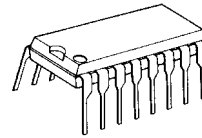

NJM2283D

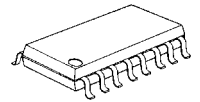

NJM2283M

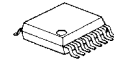

NJM2283V

NJM2283

■ MAXIMUM RATINGS

(T_a = 25°C)

PARAMETER	SYMBOL	RATINGS	UNIT
Supply Voltage	V ⁺	14	V
Power Dissipation	P _D	(DIP16) 700 (DMP16) 350 (SSOP16) 300	mW mW mW
Operating Temperature Range	T _{opr}	-40 to +85	°C
Storage Temperature Range	T _{stg}	-40 to +125	°C

■ ELECTRICAL CHARACTERISTICS

(V⁺ = 5V, T_a = 25°C)

PARAMETER	SYMBOL	CONDITION	MIN.	TYP.	MAX.	UNIT
Operating Current (1)	I _{CC1}	V ⁺ = 5V (Note1)	8.3	11.8	15.3	mA
Operating Current (2)	I _{CC2}	V ⁺ = 9V (Note1)	10.4	14.8	19.2	mA
Voltage Gain	G _V	V _I = 100kHz, 2V _{P,P} , V _O / V _I	-0.6	-0.1	+0.4	dB
Frequency Gain	G _F	V _I = 2V _{P,P} , V _O (10MHz) / V _O (100kHz)	-1.0	0	+1.0	dB
Differential Gain	DG	V _I = 2V _{P,P} , Standard Staircase Signal	-	0.3	-	%
Differential Phase	DP	V _I = 2V _{P,P} , Standard Staircase Signal	-	0.3	-	deg
Output offset Voltage	V _{OS}	(Note2)	-10	0	+10	mV
Crosstalk	CT	V _I = 2V _{P,P} , 4.43MHz, V _O / V _I	-	-75	-	dB
Switch Change Over Voltage	V _{CH}	All inside Switch ON	2.5	-	-	V
Switch Change Over Voltage	V _{CL}	All inside Switch OFF	-	-	1.0	V

(Note1) S1 = S2 = S3 = S4 = S5 = S6 = S7 = 1

(Note2) S1 = S2 = S3 = S4 = S5 = S6 = 1, S7 = 1→2 Measure the output DC voltage difference

■ TERMINAL EXPLANATION

PIN No.	PIN NAME	VOLTAGE	INSIDE EQUIVALENT CIRCUIT
16 1 11 14 8 9	IN 1 A IN 1 B IN 2 A IN 2 B IN 3 A IN 3 B [Input]	2.5V	
2 12 7	CTL 1 CTL 2 CTL 3 [Switching]		
3 5 6	OUT1 OUT2 OUT3 [Output]	1.8V	
13	V ⁺	5V	
15 4 10	GND 1 GND 2 GND 3		

NJM2283

TEST CIRCUIT

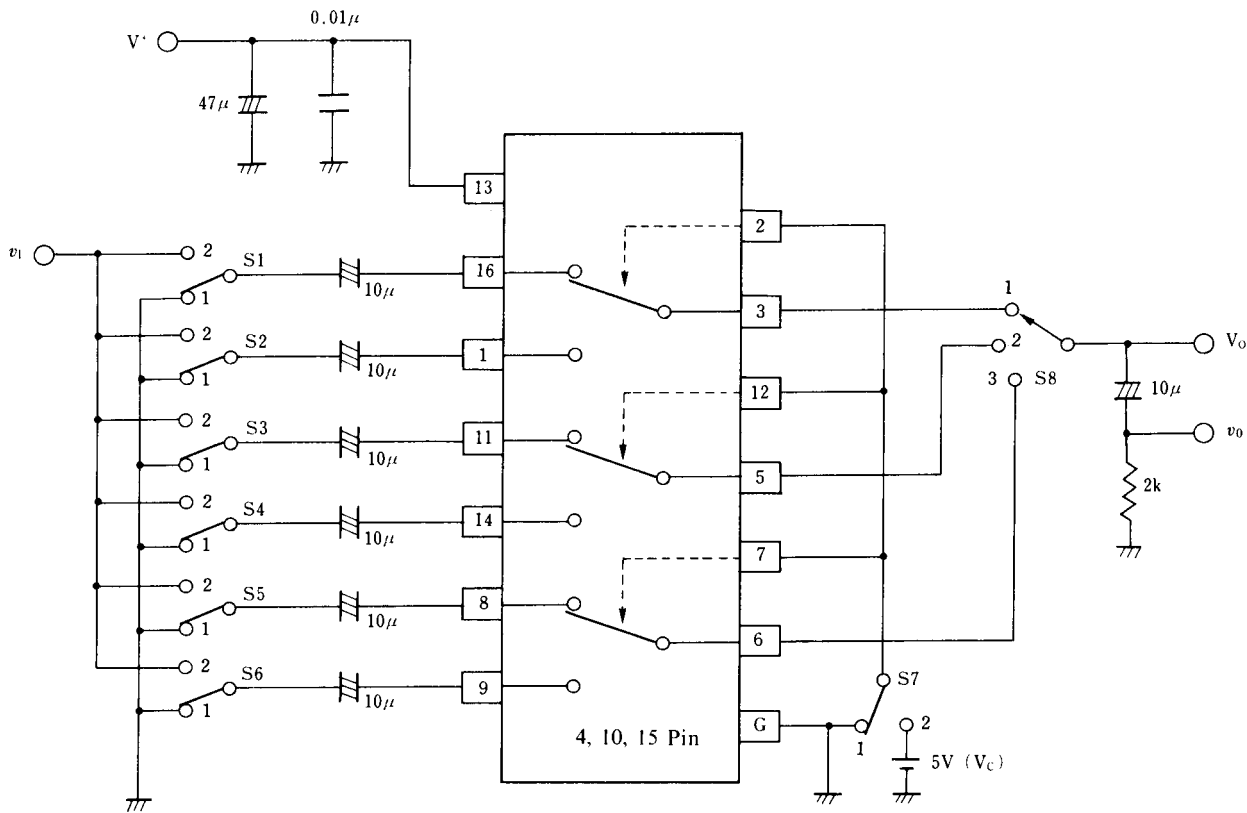

Parameter	S1	S2	S3	S4	S5	S6	S7	S8	Test Part
I_{CC1}	1	1	1	1	1	1	1	1	V^+
I_{CC2}	1	1	1	1	1	1	1	1	
G_{V1}	2	1	1	1	1	1	1	1	v_o
G_{F1}	2	1	1	1	1	1	1	1	
DG_1	2	1	1	1	1	1	1	1	
DP_1	2	1	1	1	1	1	1	1	
CT1	2	1	1	1	1	1	2	1	v_o
CT2	1	2	1	1	1	1	1	1	
CT3	1	1	2	1	1	1	2	2	
CT4	1	1	1	2	1	1	1	2	
CT5	1	1	1	1	2	1	2	3	
CT6	1	1	1	1	1	2	1	3	
V_{OS1}	1	1	1	1	1	1	1/2	1	V_o
V_{C1}	1/2	2/1	1	1	1	1	V_c	1	V_c
THD	2	1	1	1	1	1	1	1	v_o

■ TYPICAL CHARACTERISTICS

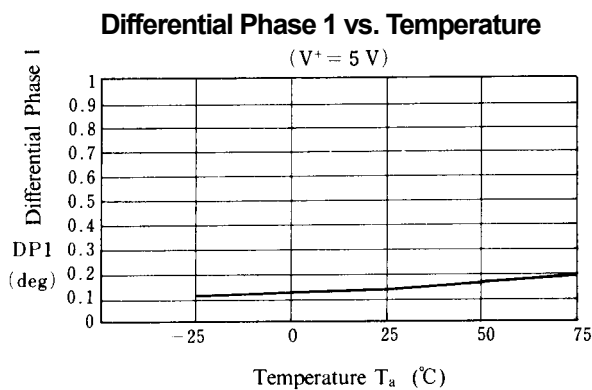
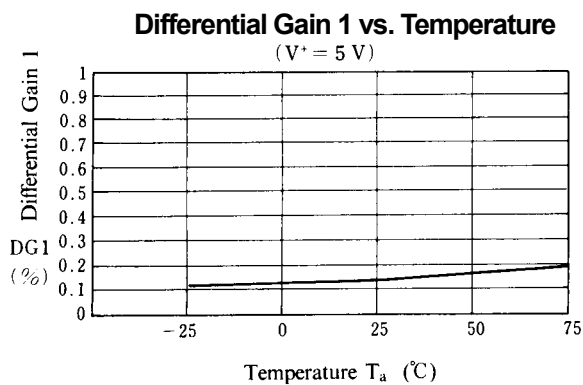
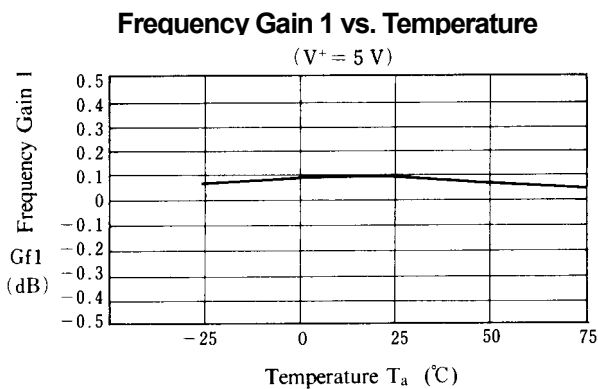
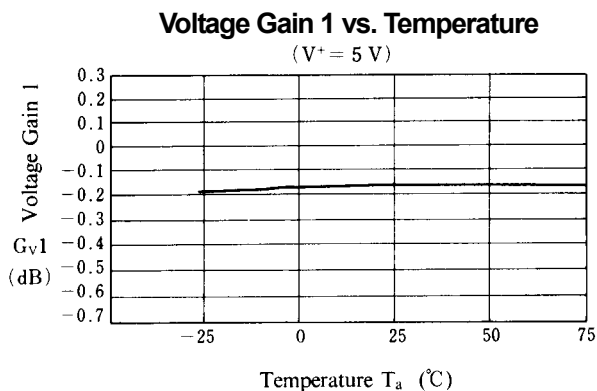
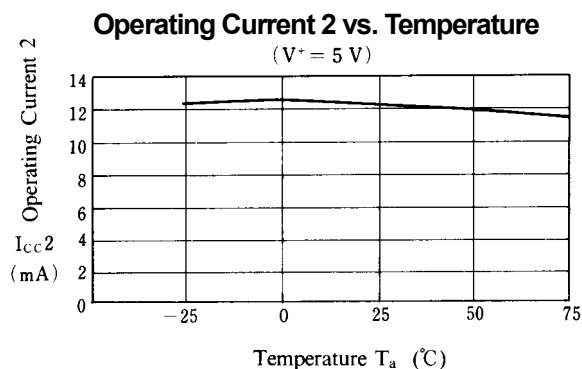
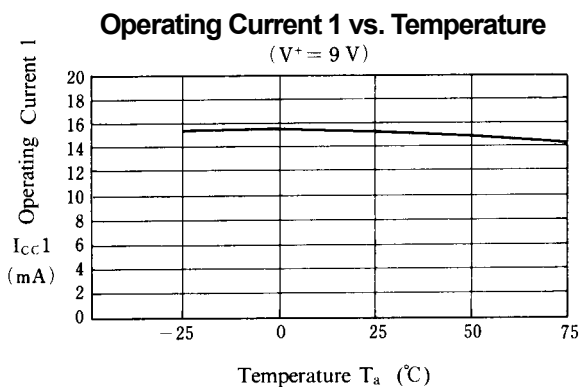

■ TYPICAL CHARACTERISTICS

Offset Voltage 1 vs. Temperature
($V^+ = 5\text{ V}$)

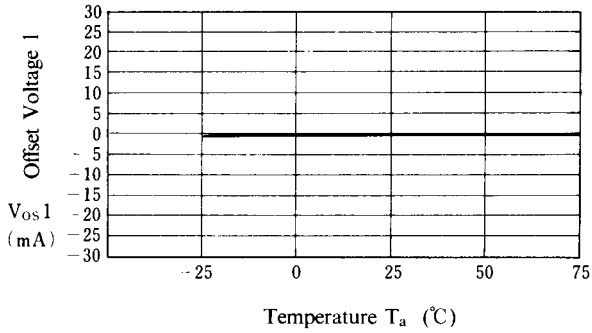

Crosstalk 1 vs. Temperature
($V^+ = 5\text{ V}$)

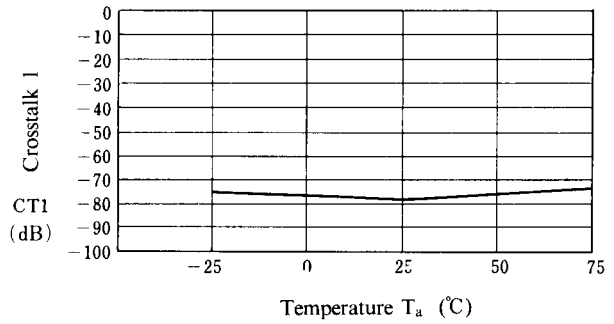

Crosstalk 2 vs. Temperature
($V^+ = 5\text{ V}$)

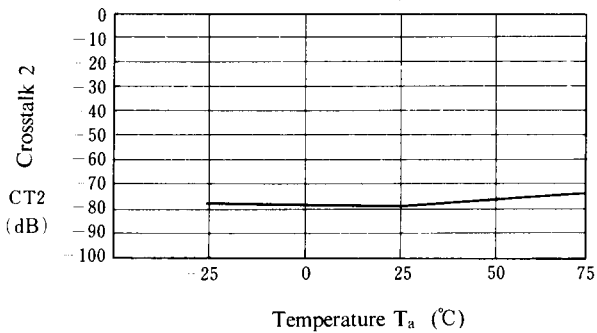

Crosstalk 3 vs. Temperature
($V^+ = 5\text{ V}$)

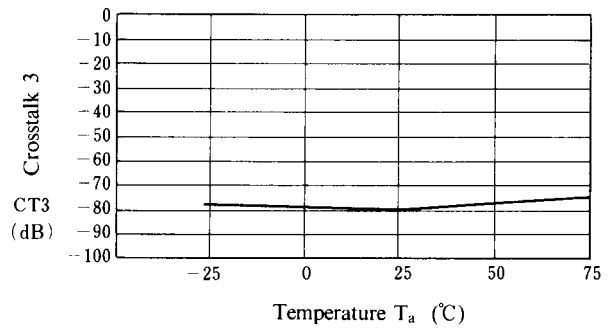

Crosstalk 4 vs. Temperature
($V^+ = 5\text{ V}$)

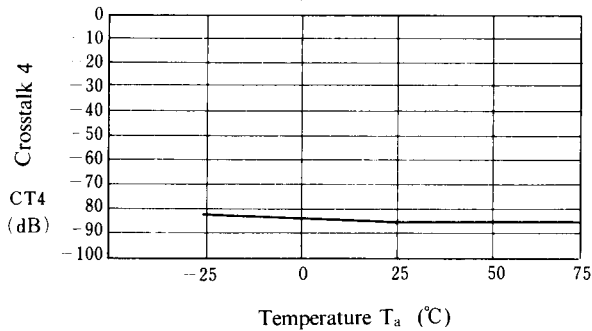

Crosstalk 5 vs. Temperature
($V^+ = 5\text{ V}$)

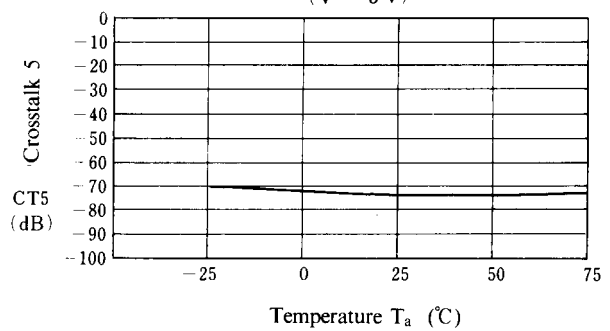

■ TYPICAL CHARACTERISTICS

Crosstalk 6 vs. Temperature
($V^+ = 5\text{ V}$)

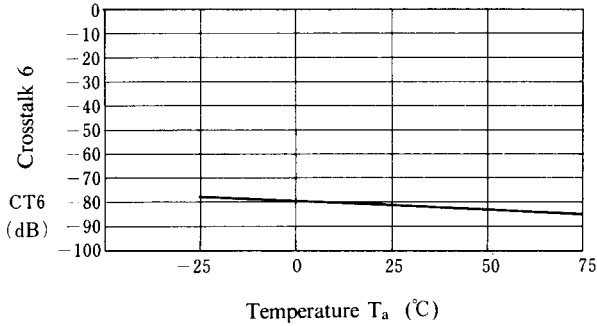

Switch Change Over 1 vs. Operating Voltage
($V^+ = 5\text{ V}$)

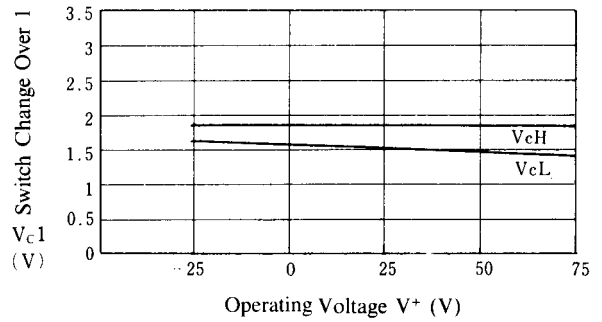

Operating Current vs. Operating Voltage
($T_a = 25^\circ\text{C}$)

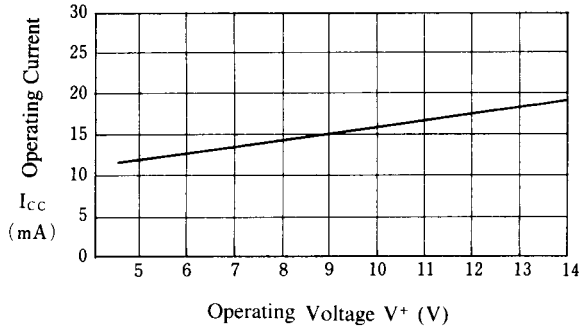

Voltage Gain 1 vs. Operating Voltage
($T_a = 25^\circ\text{C}$)

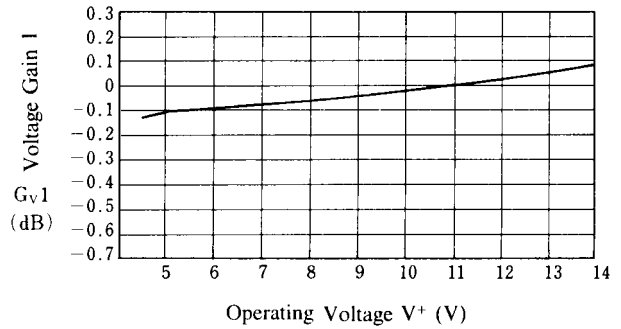

Frequency Gain 1 vs. Operating Voltage
($T_a = 25^\circ\text{C}$)

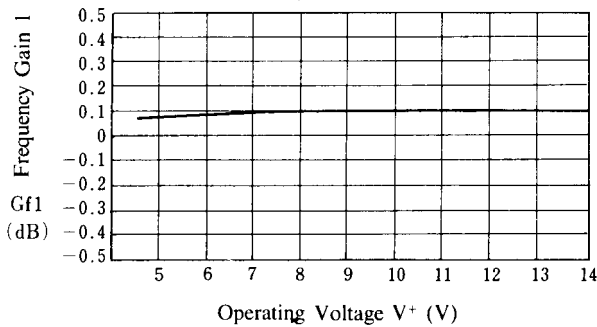

Differential Gain 1 vs. Operating Voltage
($T_a = 25^\circ\text{C}$)

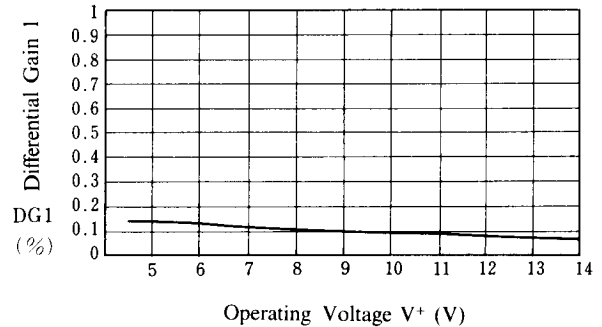

■ TYPICAL CHARACTERISTICS

Differential Phase 1 vs. Operating Voltage
($T_a = 25^\circ\text{C}$)

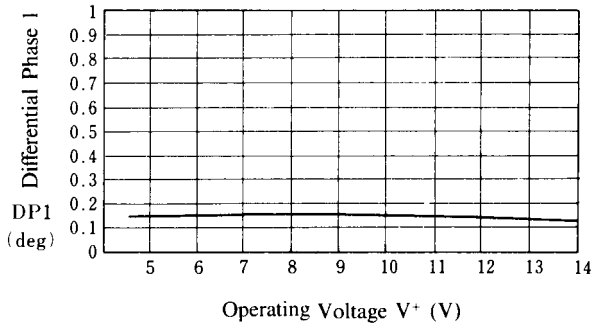

Offset Voltage 1 vs. Operating Voltage
($T_a = 25^\circ\text{C}$)

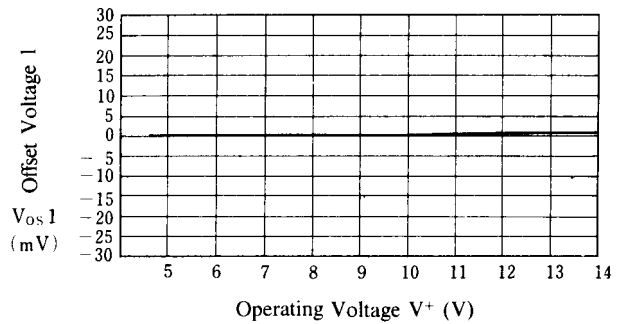

Crosstalk 1 vs. Operating Voltage
($T_a = 25^\circ\text{C}$)

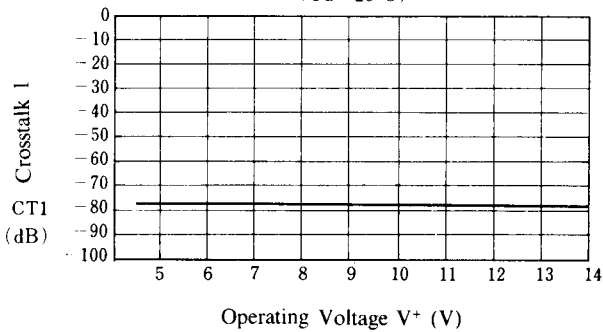

Crosstalk 2 vs. Operating Voltage
($T_a = 25^\circ\text{C}$)

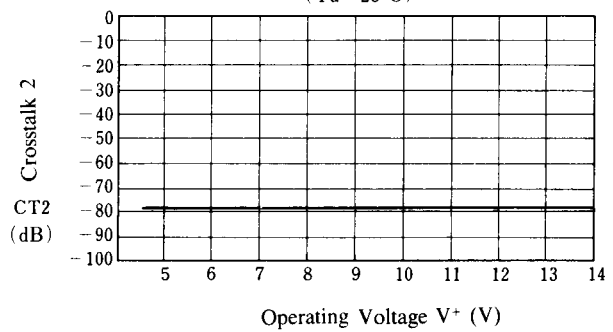

Crosstalk 3 vs. Operating Voltage
($T_a = 25^\circ\text{C}$)

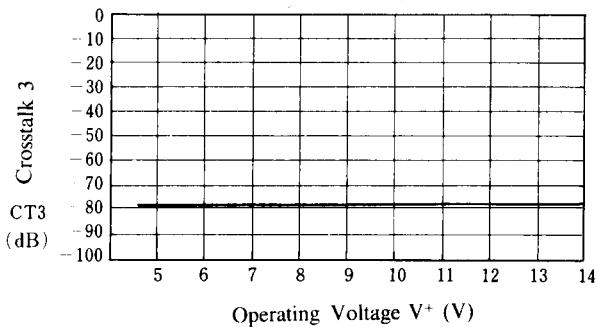

Crosstalk 4 vs. Operating Voltage
($T_a = 25^\circ\text{C}$)

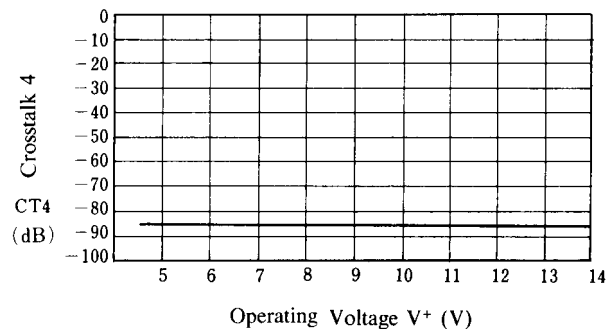

■ TYPICAL CHARACTERISTICS

Crosstalk 5 vs. Operating Voltage

($T_a = 25^\circ\text{C}$)

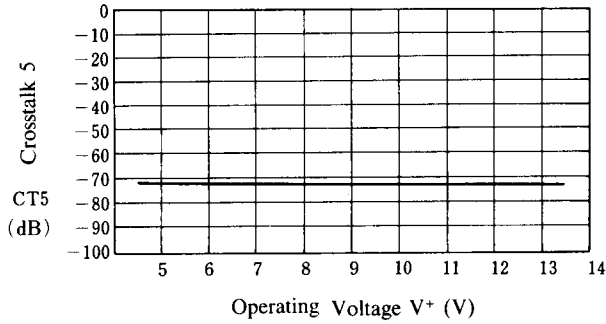

Crosstalk 6 vs. Operating Voltage

($T_a = 25^\circ\text{C}$)

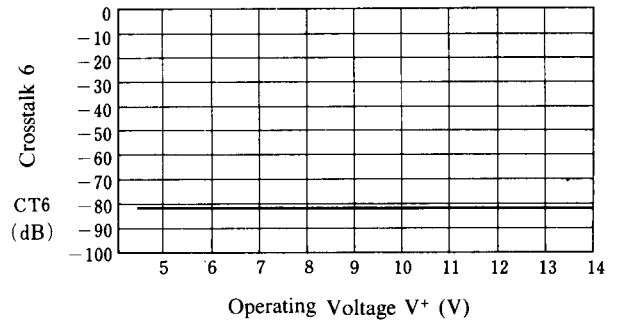

Switch Change Over 1 vs. Operating Voltage

($T_a = 25^\circ\text{C}$)

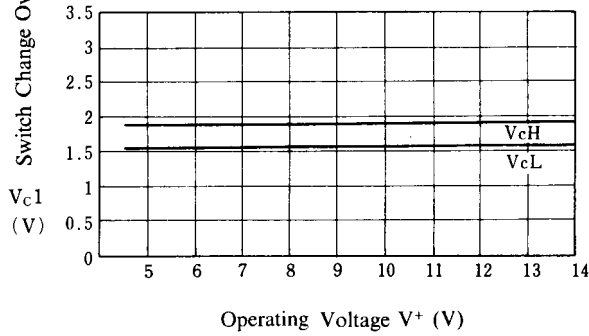

Voltage Gain 1 vs. Frequency Feature

($T_a = 25^\circ\text{C}$)

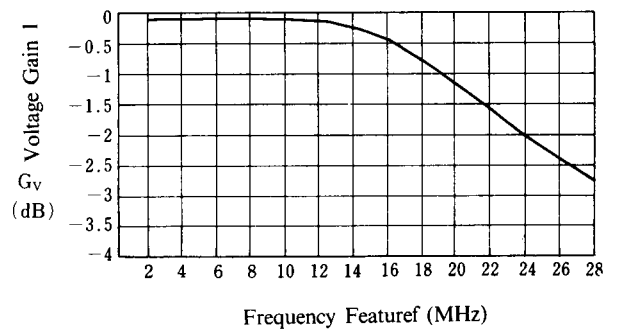

Differential Gain 1 vs. Load Resistor

($T_a = 25^\circ\text{C}$)

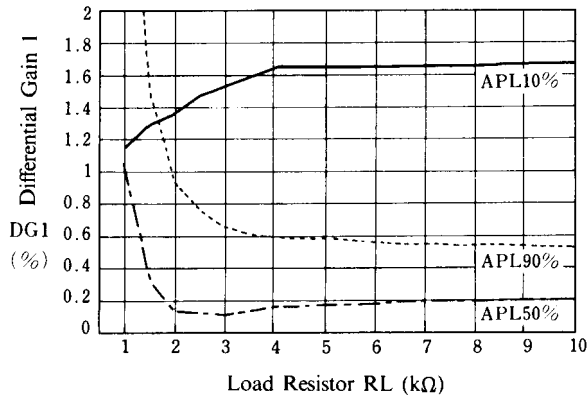

Differential Phase 1 vs. Load Resistor

($T_a = 25^\circ\text{C}$)

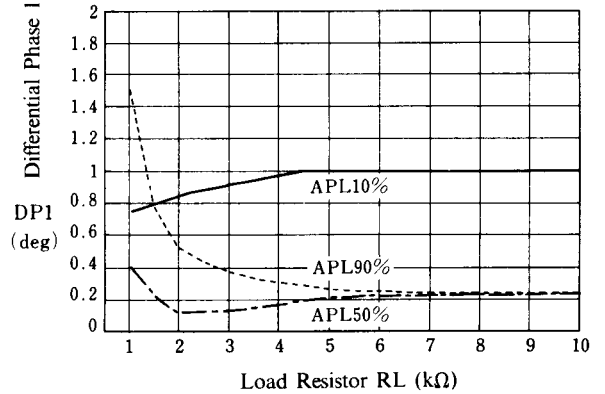

■ TYPICAL CHARACTERISTICS

Differential Gain 1 vs. APL
($T_a = 25^\circ\text{C}$)

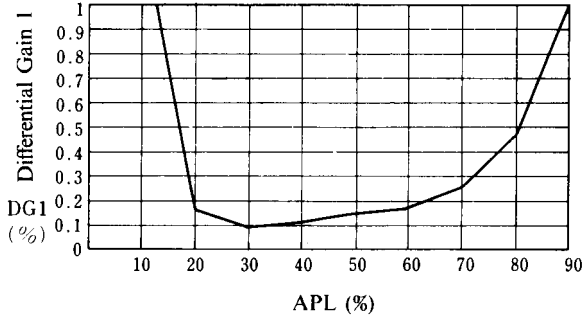

Differential Phase 1 vs. APL
($T_a = 25^\circ\text{C}$)

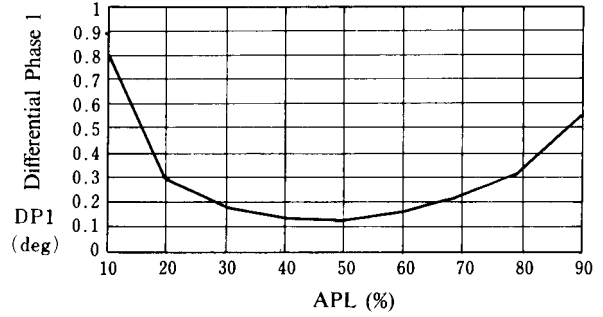

Total Harmonic Distortion vs. Load Resistor
($T_a = 25^\circ\text{C}$)

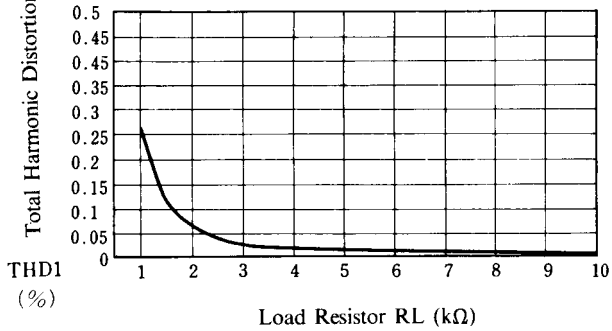

■ APPLICATION

This IC requires 0.1 μ F capacitor between INPUT and GND for bias type input at mute mode.

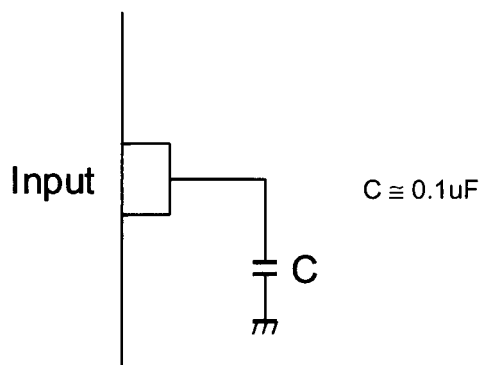

[CAUTION]
 The specifications on this databook are only given for information, without any guarantee as regards either mistakes or omissions. The application circuits in this databook are described only to show representative usages of the product and not intended for the guarantee or permission of any right including the industrial rights.