

SUMMARY

Wires

Low voltage 7



Image is for illustrative purpose only

Series	0B
Termination type	Female print PCB
IP rating	50
AWG wire size	0.00 - 0.00
Cable Ø	0.00 - 0.00 mm
Status	active
Matching parts	FGB.0B.307.CLAD5Z

Download

- [Request a quote](#)
- [PCB Eagle Pattern](#)
- [PCB Altium Pattern](#)
- [PCB KiCad Pattern](#)
- [Catalog](#)

TECHNICAL DETAILS

Mechanics

Shell Style/Model	EX*: Elbow receptacle for printed circuit with two nuts (solder or screw fixing, back panel mounting)
Keying	2 keys (alpha=60, plug: male contacts, receptacle: female contacts)
Housing Material	PPS (Polyphenylene) shell, other pieces nickel plated [SAE AMS QQ N 290] brass
Weight	10.98 g

Performance

Configuration	0B.307/EXG : 7 Low Voltage
Insulator	L: PEEK (UL 94 / V-0/1.5)
Rated Current	2 Amps

Specifications

Contact Type: Print (straight)
Contact Dia.: 0.5 mm (0.02in)
R (max): 8.7 mOhm
Test voltage contact-contact : 1 kV rms
Test voltage contact-body shell : 1 kV rms

Others

LEMO products and services are provided "as is". LEMO makes no warranties or representations with regard to LEMO product & services or use of them, express, implied or statutory, including for accuracy, completeness, or security. The user is fully responsible for his products and applications using LEMO components.

Endurance (Shell): 5000
 Temp (min / max): -55 °C / +250 °C
 Humidity (max): <=95% [at 60 deg C /140 F]
 Vibration: 15 g [10 Hz - 2000 Hz]
 Shock Resistance: 100 g [6 ms]
 Climatical Category: 50/175/21
 Shielding (min): 75 dB (10 MHz)
 Shielding (min): 40 dB (1 GHz)
 Salt Spray Corrosion: >144 hr

DRAWINGS

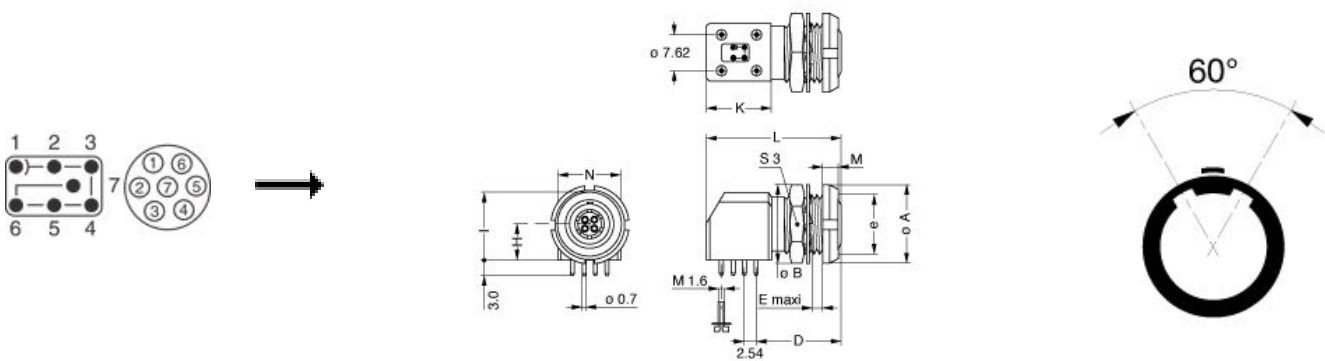

Dimensions

	A	B	D	E	H	I	K	L	M	N	S3	e
mm.	12	12.4	14.6	4.5	6.7	12.6	13.3	25	2.5	11.7	11	M9x0.6
in.	0,47	0,49	0,57	0,18	0,26	0,50	0,52	0,98	0,10	0,46	0,43	

RECOMMENDED BY LEMO

Tools

Spanner wrench: [Socket for torque wrench DCM.05.M09.4](#)

LEMO products and services are provided "as is". LEMO makes no warranties or representations with regard to LEMO product & services or use of them, express, implied or statutory, including for accuracy, completeness, or security. The user is fully responsible for his products and applications using LEMO components.

LEMO products and services are provided "as is". LEMO makes no warranties or representations with regard to LEMO product & services or use of them, express, implied or statutory, including for accuracy, completeness, or security. The user is fully responsible for his products and applications using LEMO components.