

Data sheet | Item number: 862-1505/999-950

4-conductor chassis-mount terminal strip; suitable for Ex e II applications;
without ground contact; PE-N-L1-L2-L3; 5-pole; for 3 mm \varnothing screw and nut; 4
mm²; 4,00 mm²; black

www.wago.com/862-1505/999-950

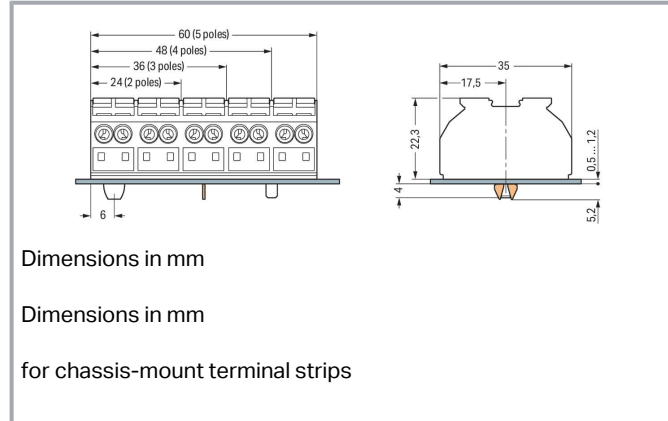
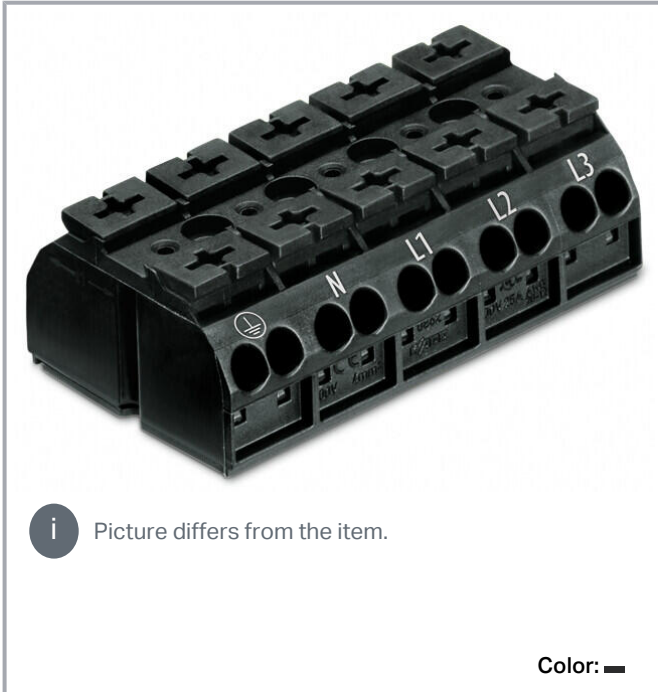

Data

Electrical data

Ex information

Rated voltage EN (Ex e II)	440 V
Rated current (Ex e II)	28 A

Connection data

Connection points	20
Total number of potentials	5
PE function	without PE contact

Connection 1

Connection technology	Push-in CAGE CLAMP®
-----------------------	---------------------

Subject to changes. Please also observe the further product documentation!

WAGO GmbH & Co. KG
Hansastr. 27
32423 Minden
Phone: +49571 887-0 | Fax: +49571 887-169
Email: info.de@wago.com | Web: www.wago.com

Do you have any questions about our products?
We are always happy to take your call at +49 (571) 887-44222.



Actuation type	Push-button
Connectable conductor materials	Copper
Solid conductor	0.5 ... 4 mm ² / 20 ... 12 AWG
Solid conductor; push-in termination	0.75 ... 4 mm ² / 18 ... 12 AWG
Stranded conductor	0.5 ... 4 mm ² / 20 ... 12 AWG
Fine-stranded conductor	0.5 ... 4 mm ² / 20 ... 12 AWG
Fine-stranded conductor; with insulated ferrule	0.5 ... 1.5 mm ² / 20 ... 16 AWG
Fine-stranded conductor; with ferrule; push-in termination	0.75 mm ² / 18 AWG
Note (conductor cross-section)	Depending on the conductor characteristic, a conductor with a smaller cross-section can also be inserted via push-in termination.
Strip length	10 ... 11 mm / 0.39 ... 0.43 inches
Pole number	5
Wiring direction	Side-entry wiring

Physical data

Pin spacing	12 mm / 0.472 inches
Width	60 mm / 2.362 inches
Height from the surface	22.3 mm / 0.878 inches
Depth	35 mm / 1.378 inches

Mechanical Data

Marking	⚡-N-L1-L2-L3
Mounting type	Screw mounting

Material Data

Note (material data)	Information on material specifications can be found here
Color	black
Material group	I
Insulation material	Polyamide (PA66)
Flammability class per UL94	V0
Fire load	0.617 MJ
Halogen-free	Yes
Weight	34.1 g

Subject to changes. Please also observe the further product documentation!

WAGO GmbH & Co. KG
 Hansastr. 27
 32423 Minden
 Phone: +49571 887-0 | Fax: +49571 887-169
 Email: info.de@wago.com | Web: www.wago.com

Do you have any questions about our products?
 We are always happy to take your call at +49 (571) 887-44222.

Commercial data



eCl@ss 10.0	27-14-11-06
eCl@ss 9.0	27-14-11-06
ETIM 8.0	EC001284
ETIM 7.0	EC001284
PU (SPU)	200 pcs
Packaging type	bag
Country of origin	DE
GTIN	4045454789213
Customs tariff number	85369010000

Environmental Product Compliance



RoHS Compliance Status	Compliant, No Exemption
------------------------	-------------------------

Approvals / Certificates

General approvals

Logo	Approval	Additional Approval Text	Certificate name
	CCC CNEX	GB/T 3836.3	2020312313000178 (Ex eb IIC Gb, Ex eb I Mb)
	CSA DEKRA Certification B.V.	C22.2 No. 158	1505030

Approvals for hazardous areas

Logo	Approval	Additional Approval Text	Certificate name
	ATEX Physikalisch Technische Bundesanstalt (PTB)	-	PTB 03 ATEX 1189 U (II 2 G Ex eb IIC Gb bzw. I M 2 Ex eb I Mb)
	CCC CNEX	GB/T 3836.3	2020312313000178 (Ex eb IIC Gb, Ex eb I Mb)
	EAC Brjansker Zertifizierungsstelle	TP TC 012/2011	RU C-DE.AM02.B. 00127/19 (Ex e IIC Gb U)

Subject to changes. Please also observe the further product documentation!



IECEX
Physikalisch Technische Bundesanstalt

IEC 60079

IECEX PTB 05.0003
U (Ex eb IIC Gb or Ex
eb I Mb)

Optional accessories

Ferrule

Ferrule		
	Item no.: 216-142 Ferrule; Sleeve for 0.75 mm ² / 18 AWG; uninsulated; electro-tin plated; electrolytic copper; gastight crimped; acc. to DIN 46228, Part 1/08.92	www.wago.com/216-142
	Item no.: 216-143 Ferrule; Sleeve for 1 mm ² / AWG 18; uninsulated; electro-tin plated; electrolytic copper; gastight crimped; acc. to DIN 46228, Part 1/08.92	www.wago.com/216-143
	Item no.: 216-141 Ferrule; Sleeve for 0.5 mm ² / 20 AWG; uninsulated; electro-tin plated; electrolytic copper; gastight crimped; acc. to DIN 46228, Part 1/08.92	www.wago.com/216-141
	Item no.: 216-144 Ferrule; Sleeve for 1.5 mm ² / AWG 16; uninsulated; electro-tin plated; electrolytic copper; gastight crimped; acc. to DIN 46228, Part 1/08.92; silver-colored	www.wago.com/216-144
	Item no.: 216-241 Ferrule; Sleeve for 0.5 mm ² / 20 AWG; insulated; electro-tin plated; electrolytic copper; gastight crimped; acc. to DIN 46228, Part 4/09.90; white	www.wago.com/216-241
	Item no.: 216-242 Ferrule; Sleeve for 0.75 mm ² / 18 AWG; insulated; electro-tin plated; electrolytic copper; gastight crimped; acc. to DIN 46228, Part 4/09.90; gray	www.wago.com/216-242
	Item no.: 216-243 Ferrule; Sleeve for 1 mm ² / AWG 18; insulated; electro-tin plated; electrolytic copper; gastight crimped; acc. to DIN 46228, Part 4/09.90; red	www.wago.com/216-243
	Item no.: 216-244 Ferrule; Sleeve for 1.5 mm ² / AWG 16; insulated; electro-tin plated; electrolytic copper; gastight crimped; acc. to DIN 46228, Part 4/09.90; black	www.wago.com/216-244

Jumpers

Jumper		
	Item no.: 862-482 Jumper; for conductor entry; insulated; black	www.wago.com/862-482

Marking accessories

Marking strip		
	Item no.: 709-178 Marking strips; on reel; 7.5 mm wide; not stretchable; plain; snap-on type; white	www.wago.com/709-178

Subject to changes. Please also observe the further product documentation!



Item no.: 709-177

Marking strips; on reel; 7.5 mm wide; not stretchable; plain; snap-on type; translucent

www.wago.com/709-177

Tool

Operating tool



Item no.: 210-720

Operating tool; Blade: 3.5 x 0.5 mm; with a partially insulated shaft; multicoloured

www.wago.com/210-720

Testing and measuring

Testing accessories



Item no.: 210-136

Test plug; 2 mm Ø; with 500 mm cable; red

www.wago.com/210-136

Downloads

Documentation

Bid Text

862-1505/999-950 X81 - Datei	2019 Feb 19	xml 3.9 kB	Download
862-1505/999-950 doc - Datei	2017 Jun 12	doc 25.1 kB	Download

Additional Information

Technical Section Technical explanations		pdf 2.2 MB	Download
---	--	---------------	----------

CAD/CAE-Data

CAD data

2D/3D Models 862-1505/999-950		URL	Download
-------------------------------	--	-----	----------

CAE data

EPLAN Data Portal 862-1505/999-950		URL	Download
------------------------------------	--	-----	----------

WSCAD Universe 862-1505/999-950		URL	Download
---------------------------------	--	-----	----------

Subject to changes. Please also observe the further product documentation!

WAGO GmbH & Co. KG
Hansastr. 27
32423 Minden
Phone: +49571 887-0 | Fax: +49571 887-169
Email: info.de@wago.com | Web: www.wago.com

Do you have any questions about our products?
We are always happy to take your call at +49 (571) 887-44222.



EPLAN Data Portal 862-1505/999-950	URL	Download
WSCAD Universe 862-1505/999-950	URL	Download
ZUKEN Portal 862-1505/999-950	URL	Download

Environmental Product Compliance

Compliance Search

Environmental Product Compliance 862-1505/999-950	URL	Download
4-conductor chassis-mount terminal strip; suitable for Ex e II applications; without ground contact; PE-N-L1-L2-L3; 5-pole; for 3 mm \varnothing screw and nut; 4 mm ² ; 4,00 mm ² ; black		

Installation Notes

Subject to changes. Please also observe the further product documentation!

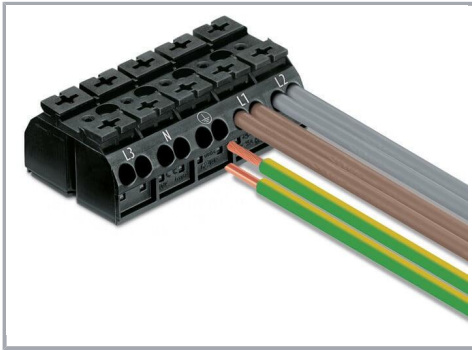

Cost-effective features:

WAGO's 862 Series Chassis-Mount Terminal Strips were developed specifically to minimize wiring costs, while accommodating requirements for flexible mounting, multiple connection points and easy usage:

- Equipped with Push-in CAGE CLAMP®, the 862 Series connects up to four conductors sized 0.5 to 4 mm² (20 ... 12 AWG). Due to multiple connection points per pole, different conductor sizes can be used within the same terminal block position.
- For factory wiring, Push-in CAGE CLAMP® Connection Technology allows solid conductors, fine-stranded conductors with ferrules or ultrasonically bonded conductors from 0.5 ... 4 mm² (20 ... 12 AWG) to be terminated by simply pushing them into unit (length of bonded conductor end: min. 10 mm).
- Convenient automatic grounding contact (optional)
- Snap-in mounting feet for fast assembly
- Push-buttons for easy installation with an operating tool or by hand
- Built-in test points simplify testing with 2 mm Ø test plug
- Standard marking for each pole, or custom marking for large orders

Conductor termination

Subject to changes. Please also observe the further product documentation!

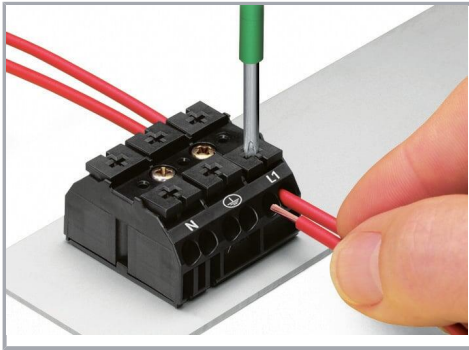

Terminating four conductors per pole – solid and fine-stranded.

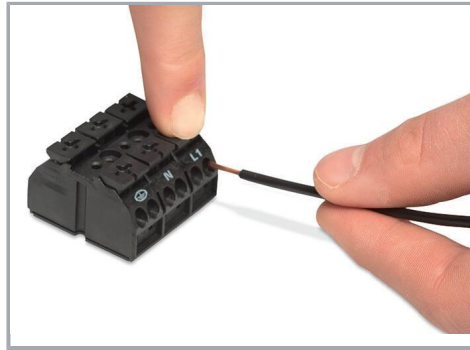

Inserting a conductor via push-button.

Commoning



Commoning using a comb-style jumper bar (862-482).

Testing

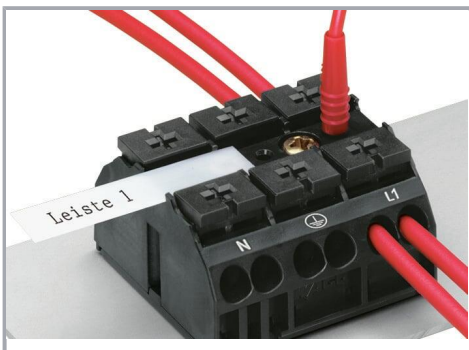

Testing with a 2 mm Ø test plug (max. 42 V).

Subject to changes. Please also observe the further product documentation!

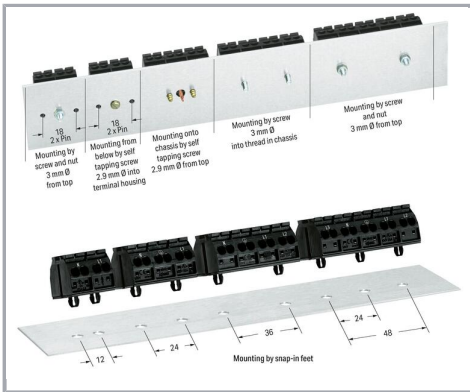

Dimensions in mm

Marking

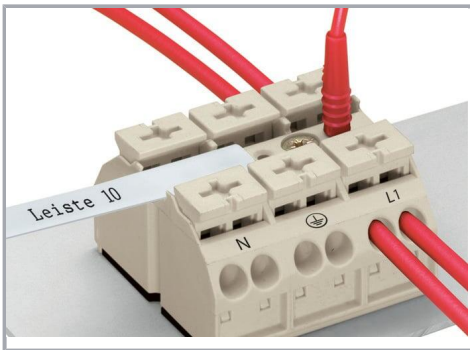

Marking by direct, one-side printing and marking strips

Subject to changes. Please also observe the further product documentation!